

ISOLATED DC/DC CONVERTERS

36 Vdc - 75 Vdc Input 1.2 Vdc /60 A, 3.3V/60A Outputs



Feb 10, 2010

Bel Power Inc., a subsidiary of Bel Fuse Inc.

0RHW-D0Txxx

RoHS Compliant

Rev.G

Features

- Fixed Frequency
- Isolated
- High Efficiency
- High Power Density
- Input Under Voltage Protection
- Basic Insulation
- Class 1, Category 2, Isolated DC/DC Converter (refer to IPC-9592)
- UL60950-1 Recognized (UL/cUL) (Pending)
- Output Over Voltage Protection
- Over Temperature Protection
- SCP/OCP
- Low Cost
- Remote On/Off



Applications

- Networking
- Computers and peripherals
- Telecommunications

Description

The 0RHW-D0Txxx series are isolated dc/dc converters that operate from a nominal 48 Vdc source. This converter provides up to 200 W of output power. Features include remote on/off, short circuit protection, over current protection, over-temperature protection, output over-voltage protection, input under-voltage protection. This converter is provided in an industry standard half brick package that is easy to use and provides good thermal performance.

Part Selection

Output Voltage	Input Voltage	Max. Output Current	Max. Output Power	Typical Efficiency	Model Number Active High	Model Number Active Low
1.2 Vdc	36 Vdc - 75 Vdc	60 A	72 W	86%	0RHW-D0TV20	0RHW-D0TV2L
3.3 Vdc	36 Vdc - 75 Vdc	60 A	200 W	92%	0RHW-D0T033	0RHW-D0T03L

Note: Add "G" suffix at the end of the model number to indicate Tray Packaging.

Part Number Explanation

$\frac{0}{1} \frac{R}{2} \frac{HW}{3} - \frac{D0}{4} \frac{T}{5} \frac{V2}{6} \frac{x}{7}$

1---Through hole

2---RoHS 6, change "R" to "7" means RoHS 5

3---Series name, 1/2 Brick

4---Series code

5---Input range

6---Output voltage, "V2" mean 1.2Vout and "03" mean 3.3Vout

7---Option, "x" of the model part number to be 0-9, A-Z, which will represent the special request of customer.

ISOLATED DC/DC CONVERTERS

36 Vdc - 75 Vdc Input 1.2 Vdc /60 A, 3.3V/60A Outputs



Feb 10, 2010

Bel Power Inc., a subsidiary of Bel Fuse Inc.

Absolute Maximum Ratings

Parameter	Min	Typ	Max	Notes
Input Voltage (continuous)	-0.3 V	-	80 V	
Input Transient Voltage	-	-	100 V	100 mS maximum
Remote On/Off	-0.3 V	-	18 V	
Ambient Temperature	-40 °C	-	85 °C	
Storage Temperature	-55 °C	-	125 °C	

Note: Ratings used beyond the maximum ratings may cause a reliability degradation of the converter or may permanently damage the device.

Input Specifications

Parameter	Min	Typ	Max	Notes
Input Voltage	36 V	48 V	75 V	
Input Current (no load) Vo=1.2V Vo=3.3V	- - -	50 mA 80 mA	100 mA 150 mA	
Input Current (full load) Vo=1.2V Vo=3.3V	- - -	- -	2.7 A 8 A	
Remote Off Input Current	-	2 mA	5 mA	
Input Reflected Ripple Current (pk-pk)	-	10 mA	20 mA	With simulated source impedance of 10uH, 5Hz to 20MHz. Use a 100uF/100V electrolytic capacitor with ESR=1 ohm max, at 200KHz@25°C.
Input Reflected Ripple Current (rms)	-	2 mA	5 mA	
I ² t Inrush Current Transient	-	-	1 A ² s	
Turn-on Voltage Threshold	32 V	34 V	35 V	
Turn-off Voltage Threshold	30 V	32 V	34 V	

CAUTION: This converter is not internally fused. An input line fuse must be used in application.

Recommend a fast-acting fuse with maximum rating of 4A@1.2Vout or 10A@3.3Vout on system board. Refer to the fuse manufacture's datasheet for further information.

Notes: 1. This converter has internal C-L-C (0.47uF-2.2uH-4.4uF) filter.
2. All specifications are typical at 25 °C unless otherwise stated.

ISOLATED DC/DC CONVERTERS

36 Vdc - 75 Vdc Input 1.2 Vdc /60 A, 3.3V/60A Outputs



Feb 10, 2010

Bel Power Inc., a subsidiary of Bel Fuse Inc.

Output Specifications

Parameter	Min	Typ	Max	Notes
Output Voltage Set Point Vo=1.2V Vo=3.3V	1.176 V 3.234 V	1.2 V 3.3 V	1.224 V 3.366 V	Vin=48 V, Io=50%Load
Line Regulation Vo=1.2V Vo=3.3V	- -	2 mV 5 mV	5 mV 10 mV	Vin=36-75 V, full load
Load Regulation Vo=1.2V Vo=3.3V	- -	5 mV 8 mV	10 mV 15 mV	Vin=48 V, Iout=0-60 A
Regulation Over Temperature (-40 °C to 85 °C) Vo=1.2V Vo=3.3V	- -	- -	10 mV 20 mV	Vin=48 V, Iout=0-60 A
Output Current	0 A	-	60 A	
Current Limit Threshold	65 A	75 A	85 A	
Ripple and Noise (pk-pk) Vo=1.2V Vo=3.3V	- -	60 mV 60 mV	100 mV 100 mV	0-20MHz BW, with a 1µF ceramic capacitor and a 10uF Tantalum cap at output.
Ripple and Noise (rms) Vo=1.2V Vo=3.3V	- -	15 mV 15 mV	30 mV 40 mV	
Ripple and Noise (pk-pk) Vo=1.2V Vo=3.3V	- -	- -	150 mV 150 mV	over all operating input voltage, load and ambient temperature condition
Rise Time Vo=1.2V Vo=3.3V	0.5 mS 5 mS	- -	5 mS 10 mS	
Turn on Time Vo=1.2V Vo=3.3V	- -	30 mS 30 mS	50 mS 50 mS	Enable form Vin and ON/OFF
Overshoot at Turn on	-	-	3%	
Output Capacitance Vo=1.2V Vo=3.3V	0 470	- -	30,000 uF 20,000 uF	

Transient Response

50% ~ 75% Max Load	Overshoot	Vo=1.2 V	-	60 mV	120 mV	di/dt=0.1A/us, Vin=48Vdc, Ta=25 °C	
	Settling Time		-	150 uS	200 uS		
75% ~ 50% Max Load	Overshoot		-	60 mV	120 mV		
	Settling Time		-	150 uS	200 uS		
50% ~ 75% Max Load	Overshoot		Vo=3.3 V	-	60 mV		120 mV
	Settling Time			-	150 uS		200 uS
75% ~ 50% Max Load	Overshoot	-		60 mV	120 mV		
	Settling Time	-		150 uS	200 uS		

Note: All specifications are typical at nominal input, full load at 25 °C unless otherwise stated.

ISOLATED DC/DC CONVERTERS

36 Vdc - 75 Vdc Input 1.2 Vdc /60 A, 3.3V/60A Outputs



Feb 10, 2010

Bel Power Inc., a subsidiary of Bel Fuse Inc.

General Specifications

Parameter	Min	Typ	Max	Notes
Efficiency Vo=1.2V Vo=3.3V	86% 90%	88% 92.5%	- -	Vin=48 V, full load
Switching Frequency Vo=1.2V Vo=3.3V	270 kHz 340 kHz	280 kHz 350 kHz	300 kHz 360 kHz	
Remote Sense Compensation	-	-	10%	The voltage increased by trim and sense should not exceed 110%Vout.
Output Voltage Trim Range	80%	-	110%	
Over Temperature Protection	-	120 °C	130 °C	
Over Voltage Protection (Static) Vo=1.2V Vo=3.3V	1.35 V 3.5 V	- -	1.7 V 5 V	
Over Voltage Protection (Dynamic) Vo=1.2V Vo=3.3V	- -	- -	1.8 V 5.6 V	The transient over voltage must be measured at Rtrimup ≥ 5K
FIT	634			Calculated Per Bell Core SR-332 (Vin=48 V, Vo=1.2 V, Io=80%, Ta = 25 °C, FIT=10 ⁹ /MTBF)
Dimensions Inches (L × W × H) Millimeters (L × W × H)	2.28 x 2.40 x 0.50 57.91 x 60.96 x 12.70			
Weight	-	93.5 g	-	
Isolation characteristics				
Input to Output	-	-	1500 V	
Input to Case	-	-	1500 V	
Output to Case	-	-	500 V	
Isolation Resistance	10M ohm	-		
Isolation Capacitance	-	1500 pF	-	

Note: All specifications are typical at 25 °C unless otherwise stated.

Control Specifications

Parameter	Min	Typ	Max	Notes	
Remote On/Off					
Signal Low (Unit On)	Active Low	-0.3 V	-	0.8 V	The Remote On/Off pin is open, Unit off.
Signal High (Unit Off)		2.4 V	-		
Signal Low (Unit Off)	Active High	-0.3 V	-	0.8 V	The Remote On/Off pin is open, Unit on.
Signal High (Unit On)		2.4 V	-		
Signal High (Unit On)		0 mA	-	1 mA	

ISOLATED DC/DC CONVERTERS

36 Vdc - 75 Vdc Input 1.2 Vdc /60 A, 3.3V/60A Outputs



Feb 10, 2010

Bel Power Inc., a subsidiary of Bel Fuse Inc.

Output Trim Equations

For 1.2V Model

Equations for calculating the trim resistor are shown below. The Trim Down resistor should be connected the Trim pin, Sense(-) pin and GND pin. The Trim Up resistor should be connected the Trim pin, Sense(+) pin and Vout pin. Only one of the resistors should be used for any given application.

$$R_{trimup} = \frac{5.1 \cdot V_o(100 + \delta)}{0.6 \cdot \delta} - \frac{510}{\delta} - 6.1 [k\Omega]$$

$$R_{trimdown} = \frac{510}{|\delta|} - 6.1 [k\Omega]$$

Note:

$$\delta = \frac{(V_{adj} - V_o)}{V_o} \times 100 [\%]$$

Output voltage $V_o = 1.201 \text{ V} @ I_{out} = 0$

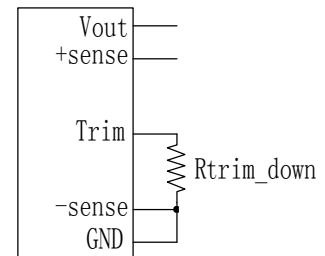
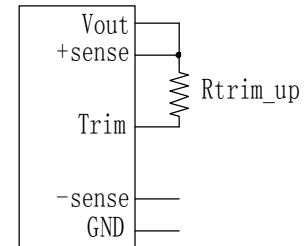

For 3.3V Model

Equations for calculating the trim resistor are shown below. The Trim Down resistor should be connected the Trim pin and GND pin. The Trim Up resistor should be connected the Trim pin and Vout pin. Only one of the resistors should be used for any given application.

$$R_{trimup} = \frac{(100 + \Delta\%) \cdot V_o}{1.225 \cdot \Delta\%} - \frac{100 + 2 \cdot \Delta\%}{\Delta\%} [k\Omega]$$

$$R_{trimdown} = \frac{100}{\Delta\%} - 2 [k\Omega]$$

Note:

$$\Delta\% = \left| \frac{V_{DES} - V_o}{V_o} \right| \times 100$$

V_o_{req} = Desired(trimmed) output voltage[V]

Output voltage $V_o = 3.3 \text{ V}$

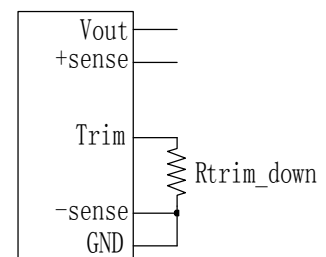
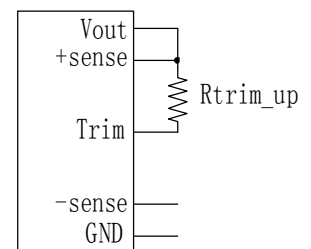

ISOLATED DC/DC CONVERTERS

36 Vdc - 75 Vdc Input 1.2 Vdc /60 A, 3.3V/60A Outputs



Feb 10, 2010

Bel Power Inc., a subsidiary of Bel Fuse Inc.

Efficiency Data

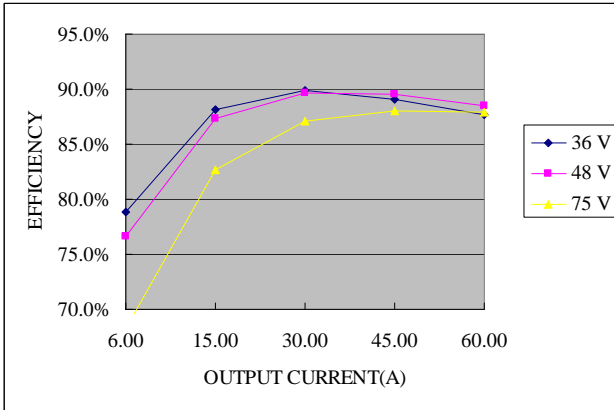

Vo=1.2 V

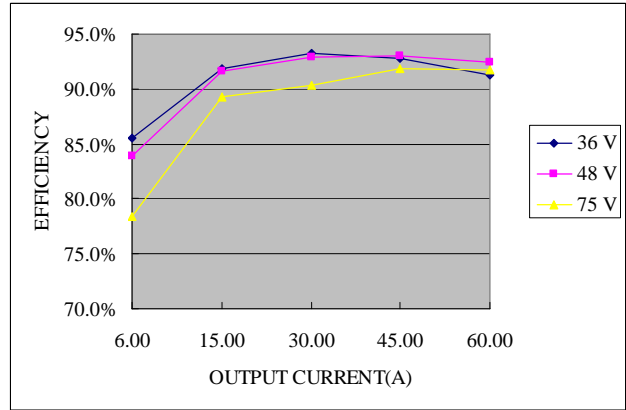

Vo=3.3 V

Thermal Derating Curves

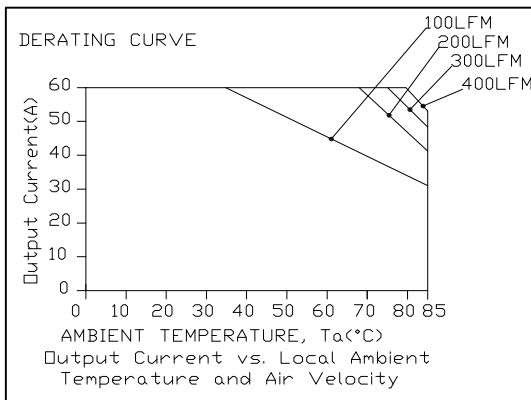
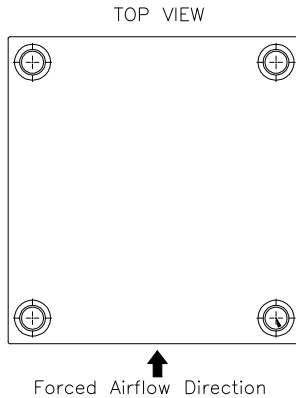

Vo=1.2V

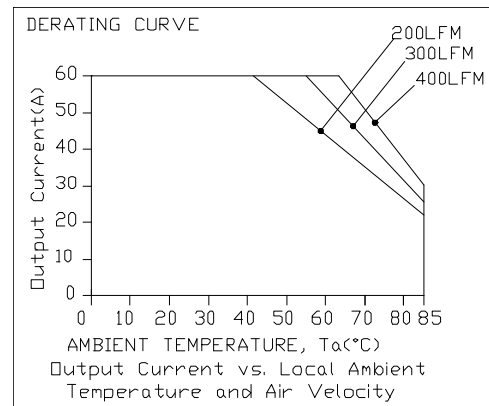

Vo=3.3V

ISOLATED DC/DC CONVERTERS

36 Vdc - 75 Vdc Input 1.2 Vdc /60 A, 3.3V/60A Outputs



Feb 10, 2010

Bel Power Inc., a subsidiary of Bel Fuse Inc.

Thermal Derating Curves (continued)

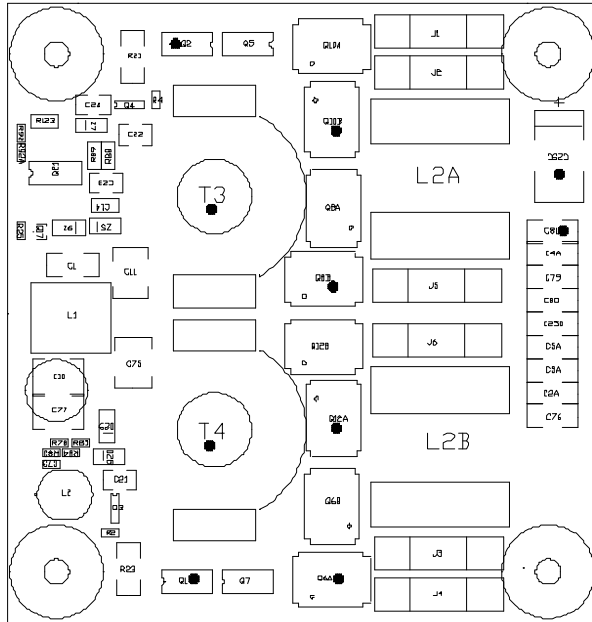

Temperature reference points on top side

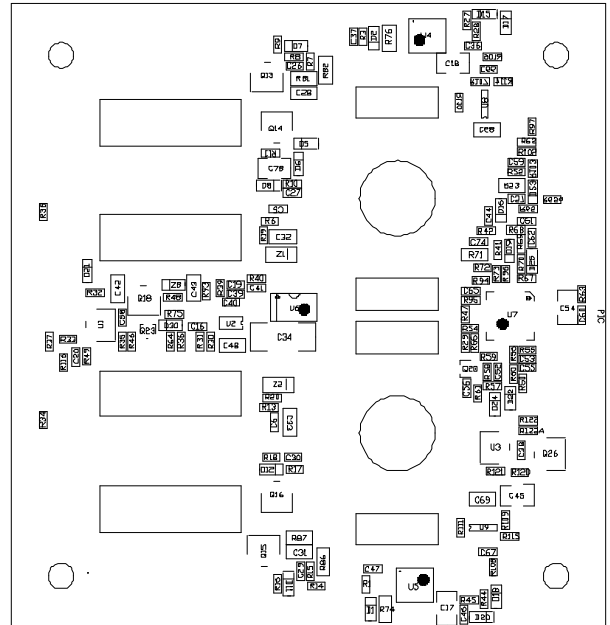

Temperature reference points on bottom side

Ripple and Noise Waveform

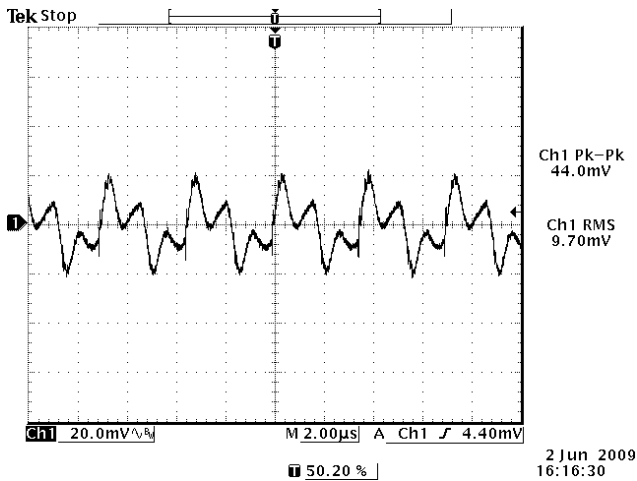

Ripple and noise at 48 V input, 1.2 V output

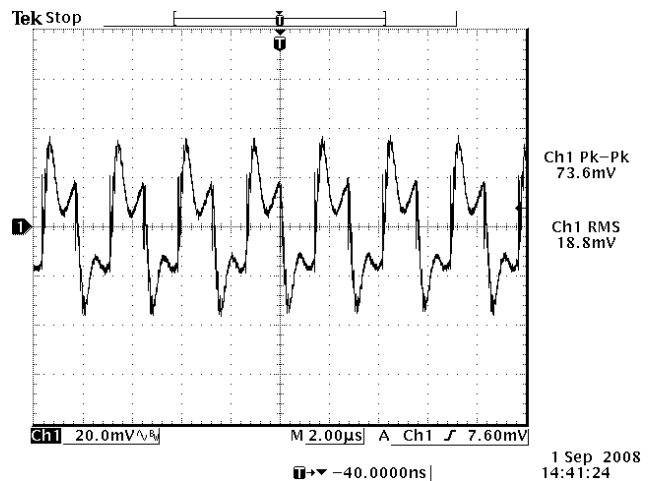

Ripple and noise at 48 V input, 3.3 V output

Note: Output ripple and noise at full load, 0-20MHz BW, with 10 uF/10 V Tan Cap and 1uF/50V ceramic cap at the output, Ta=25 deg C.

Feb 10, 2010

Bel Power Inc., a subsidiary of Bel Fuse Inc.

Transient Response Waveforms

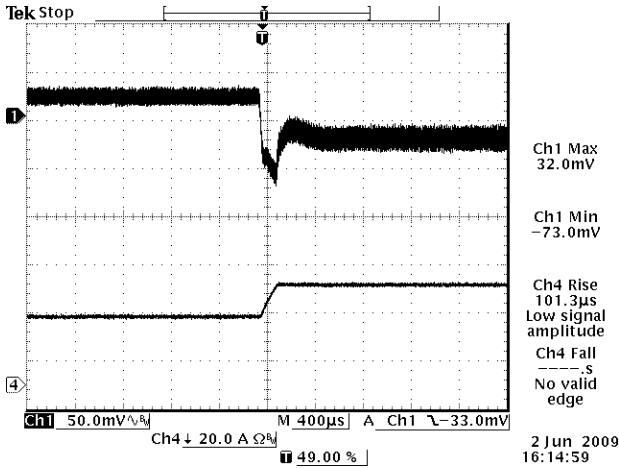

50%-75% Load Transients at Vin=48 V, Vo=1.2 V

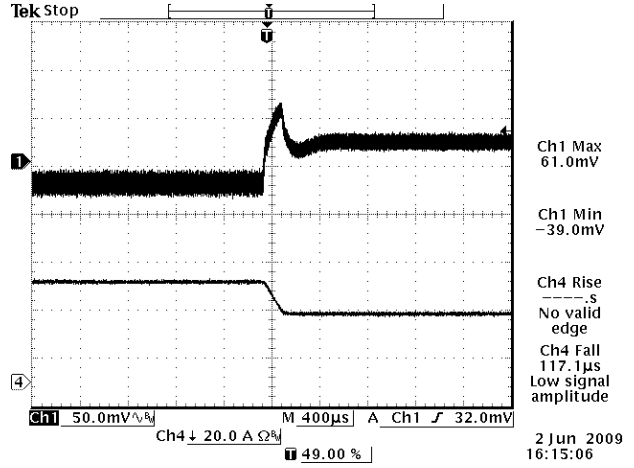

75%-50% Load Transients at Vin=48 V, Vo=1.2 V

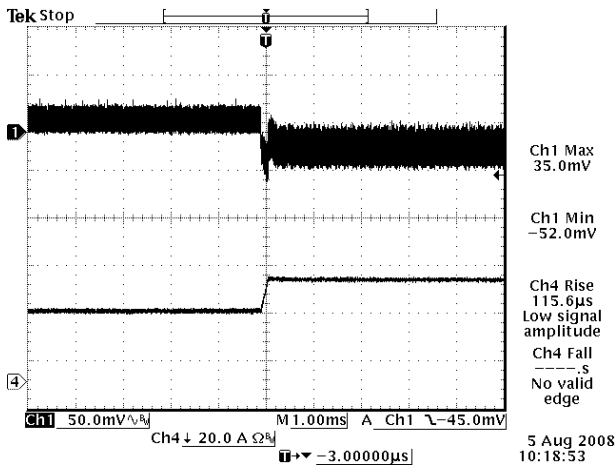

50%-75% Load Transients at Vin=48 V, Vo=3.3 V

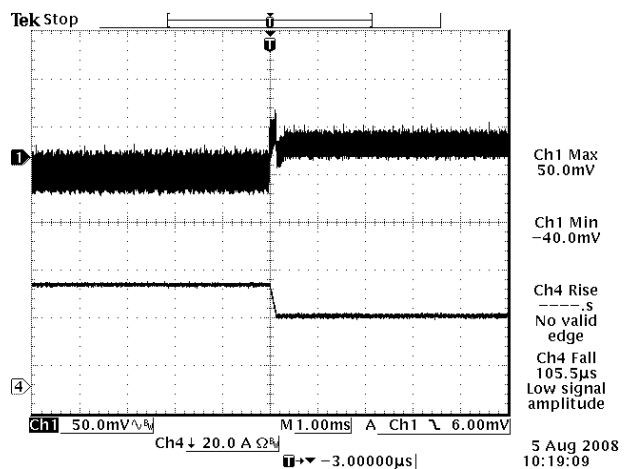

75%-50% Load Transients at Vin=48 V, Vo=3.3 V

Note: Transient response at di/dt=0.1A/uS, with 10uF/10V Tan cap and 1uF/50V ceramic cap at the output, Ta=25 deg C.

ISOLATED DC/DC CONVERTERS

36 Vdc - 75 Vdc Input 1.2 Vdc /60 A, 3.3V/60A Outputs



Feb 10, 2010

Bel Power Inc., a subsidiary of Bel Fuse Inc.

Start Up

Rise Time

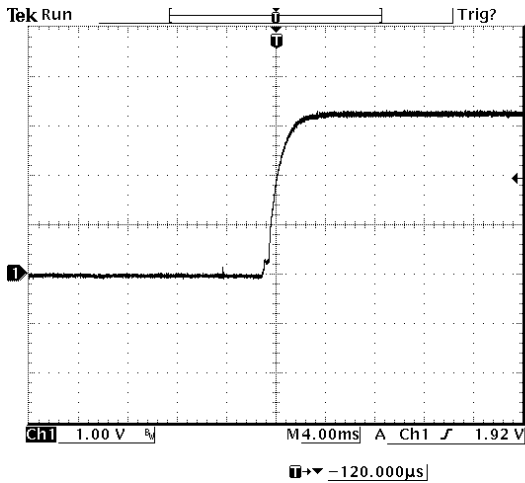

Vin=48V, Vo=3.3V, Io=60A

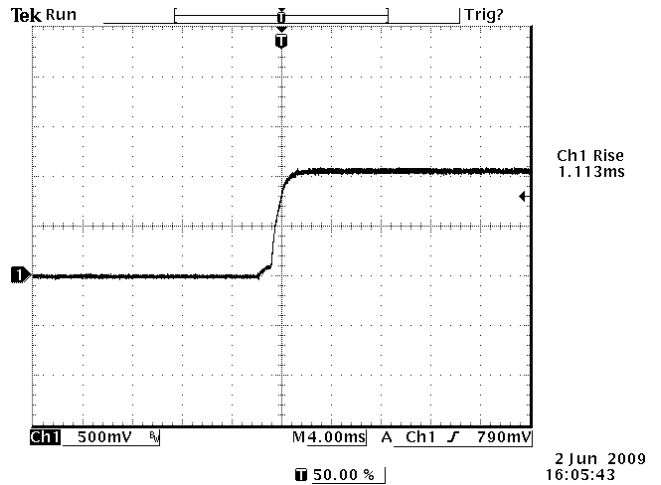

Vin=48V, Vo=1.2V, Io=60A

Startup time

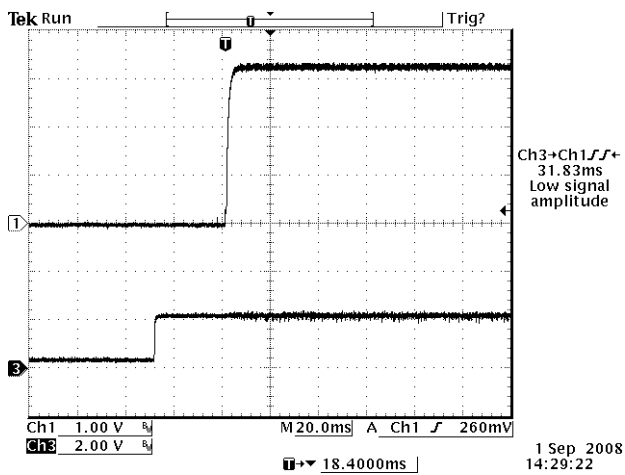

Startup from Vin
Ch1: Vo, Ch3: Vin
Vin=48V, Vo=3.3V, Io=60A

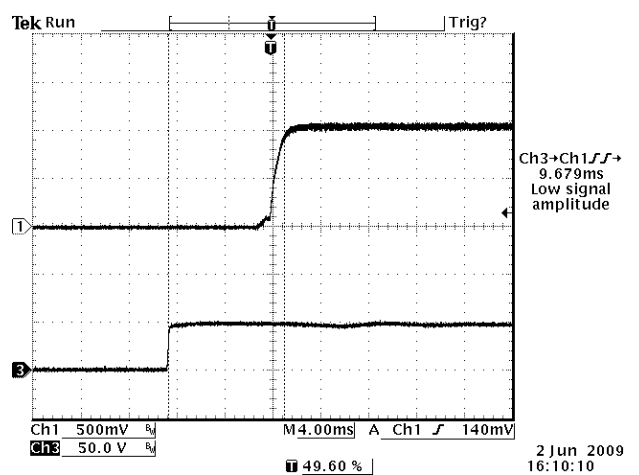

Startup from Vin
Ch1: Vo, Ch3: Vin
Vin=48V, Vo=1.2V, Io=60A

ISOLATED DC/DC CONVERTERS

36 Vdc - 75 Vdc Input 1.2 Vdc /60 A, 3.3V/60A Outputs



Feb 10, 2010

Bel Power Inc., a subsidiary of Bel Fuse Inc.

Safety & EMC

Safety

1. Material flammability UL94V-0
2. UL Certification UL60950-1

EMC

1. Surge IEC61000-4-5
2. DC-DIP IEC61000-4-29
3. Conductive EMI EN55022 class A

Compliance to EN55022 class A (both q.peak and average) with the following inductive and capacitive filter

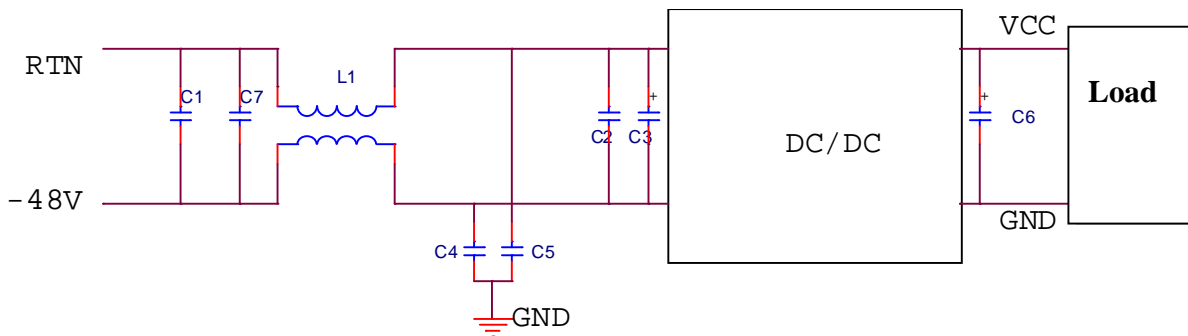

Item	Designator	Parameter	Vendor	Vendor P/N
1	C1	1uF/100V,ceramic	Murata	GRM32ER72A105KA01L
2	C2	0.1uF/100V, ceramic	TDK	C3216X7R2A104K
3	C3	100uF/100V, AL cap	Nichicon	UVZ2A101MPD
4	C4	100nF/1000V,ceramic	Johanson	102S47W104KV4
5	C5	100nF/1000V,ceramic	Johanson	102S47W104KV4
6	C6	N/A		
7	C7	1uF/100V,ceramic	Murata	GRM32ER72A105KA01L
8	T1	1.3mH, common mode	Pulse	P0402NL

ISOLATED DC/DC CONVERTERS

36 Vdc - 75 Vdc Input 1.2 Vdc /60 A, 3.3V/60A Outputs



Feb 10, 2010

Bel Power Inc., a subsidiary of Bel Fuse Inc.

Safety & EMC (continued)

Positive: $V_o=1.2V$

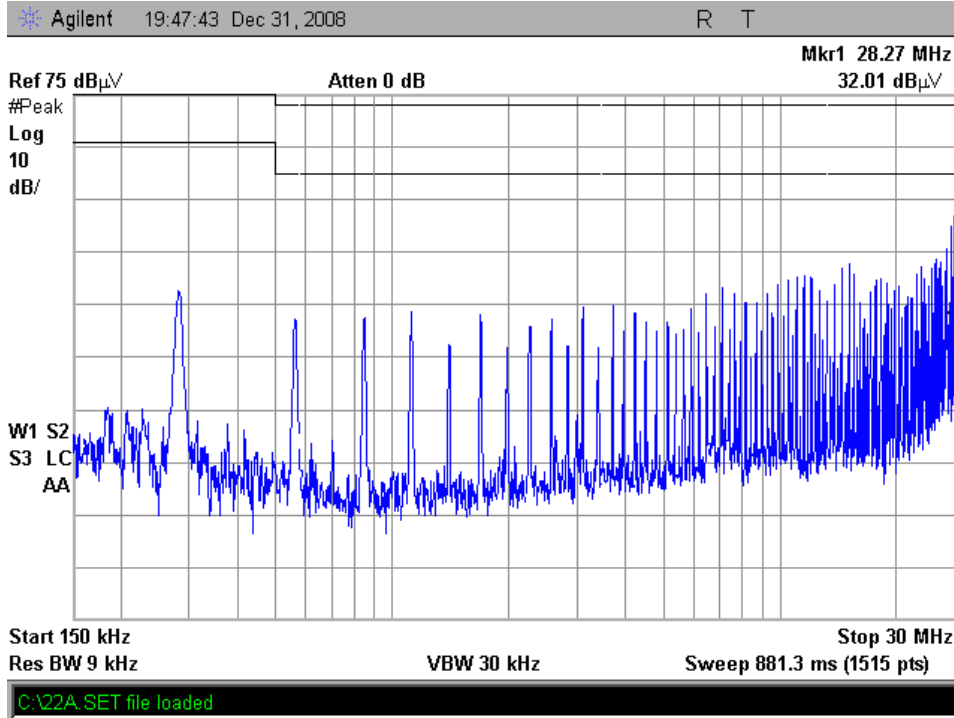

Negative: $V_o=1.2V$

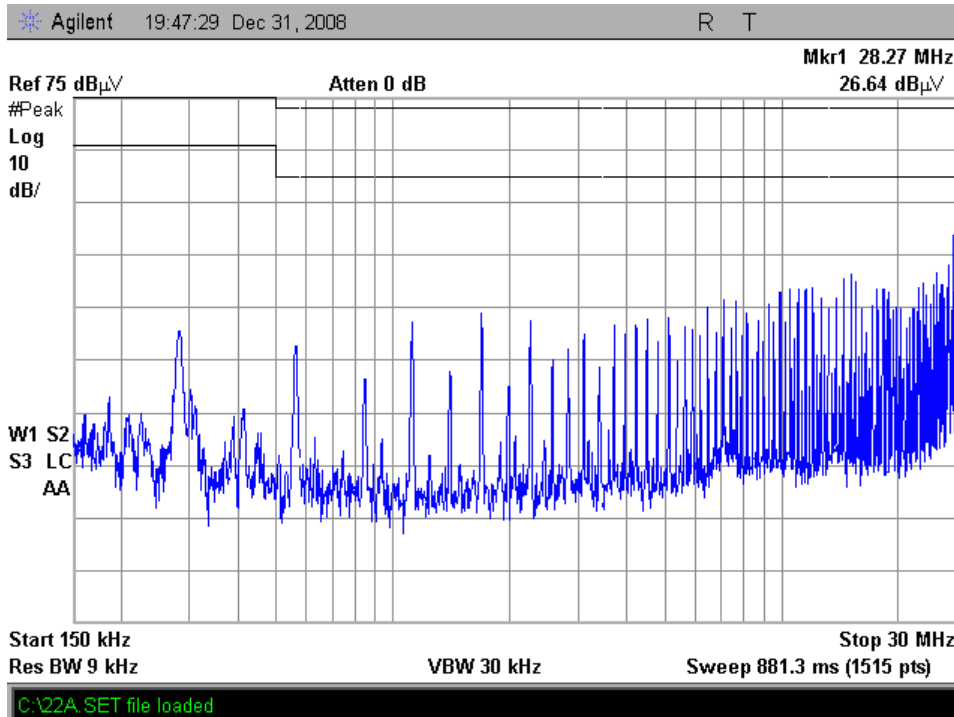

ISOLATED DC/DC CONVERTERS

36 Vdc - 75 Vdc Input 1.2 Vdc /60 A, 3.3V/60A Outputs



Feb 10, 2010

Bel Power Inc., a subsidiary of Bel Fuse Inc.

Safety & EMC (continued)

Positive: $V_o=3.3V$

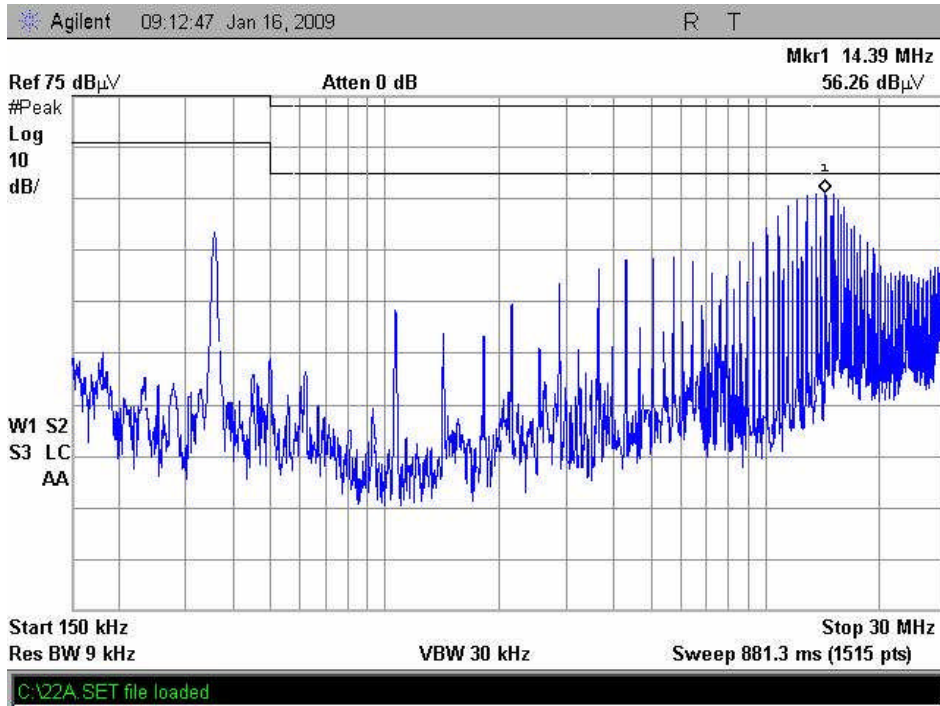

Negative: $V_o=3.3V$

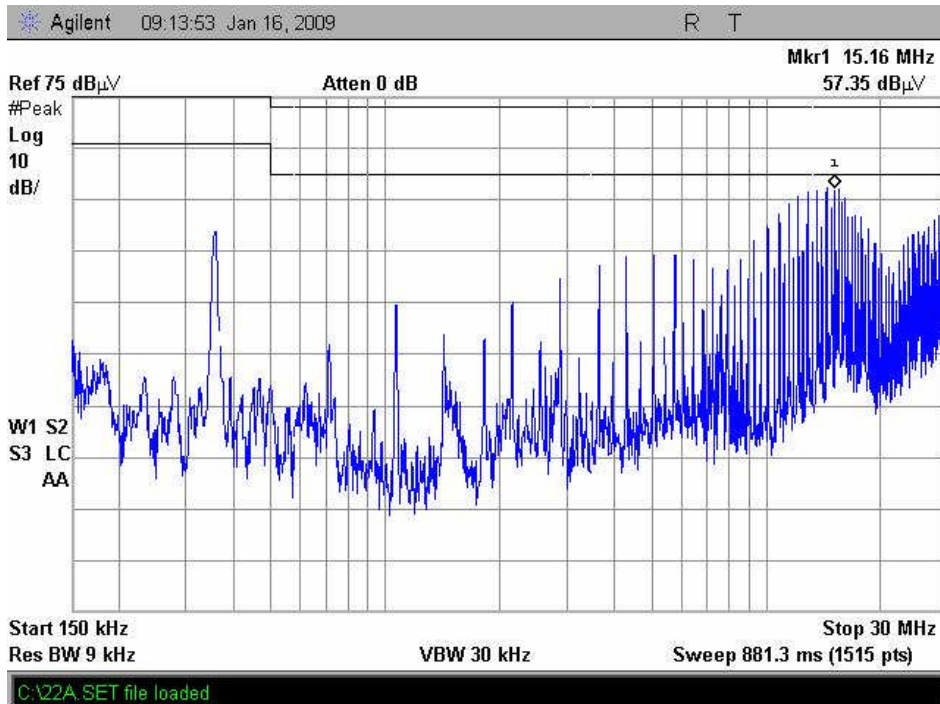

ISOLATED DC/DC CONVERTERS

36 Vdc - 75 Vdc Input 1.2 Vdc /60 A, 3.3V/60A Outputs



Feb.10, 2010

Bel Power Inc., a subsidiary of Bel Fuse Inc.

Revision History

Date	Revision	Changes Detail	Approval
2009-12-17	F	1. Update to Bel new datasheet version, add part number explanation, start-up, safety and so on; 2. add 1.2Vout spec	YP/Falling
2010-1-29	G	1. Update thermal derating curve for 3.3Vout.	YP/Falling
2010-2-10	H	1. Update thermal derating curve for 1.2Vout. Change the figure of air direction	YP/Falling

RoHS Compliance

Complies with the European Directive 2002/95/EC, calling for the elimination of lead and other hazardous substances from electronic products.



©2010 Bel Fuse Inc. Specifications subject to change without notice. 012910

CORPORATE

Bel Fuse Inc.
206 Van Vorst Street
Jersey City, NJ 07302
Tel 201-432-0463
Fax 201-432-9542
www.belfuse.com

FAR EAST

Bel Fuse Ltd.
8F/ 8 Luk Hop Street
San Po Kong
Kowloon, Hong Kong
Tel 852-2328-5515
Fax 852-2352-3706
www.belfuse.com

EUROPE

Bel Fuse Europe Ltd.
Preston Technology Management Centre
Marsh Lane, Suite G7, Preston
Lancashire, PR1 8UD, U.K.
Tel 44-1772-556601
Fax 44-1772-888366
www.belfuse.com