

ISOLATED DC/DC CONVERTERS

36 - 75 Vdc Input 1.8 Vdc /60 A Output



Feb. 21, 2011

Bel Power Inc., a subsidiary of Bel Fuse Inc.

0RQ1-C5TV8x RoHS Compliant Rev.E

Features

- Isolated
- Fixed Frequency (350 kHz)
- High Efficiency
- High Power Density
- Input Under-Voltage Protection
- Class 1, Category 2, Isolated DC/DC Converter (refer to IPC-9592)
- UL60950-1 Recognized (UL/cUL) (Pending)
- Low Cost
- Output Over-Voltage Protection
- Over Temperature Protection
- SCP/OCP
- Remote On/Off

Applications

- Networking
- Computers and peripherals
- Telecommunications

Description

The 0RQ1-C5TV8x is an isolated dc/dc converter that operates from a nominal 48 Vdc source. This converter provides up to 108 W of output power. Features include remote on/off, short circuit protection, over current protection, over-temperature protection, output over-voltage protection, input under-voltage protection. This converter is provided in a compact, through-hole package that is easy to use and provides good thermal performance.

Part Selection

Output Voltage	Input Voltage	Max. Output Current	Max. Output Power	Typical Efficiency	Model Number Active High	Model Number Active Low
1.8 Vdc	36 Vdc - 75 Vdc	60 A	108 W	89%	0RQ1-C5TV8A	0RQ1-C5TV8B
1.8 Vdc	36 Vdc - 75 Vdc	60 A	108 W	89%	0RQ1-C5TV80	0RQ1-C5TV8L

Notes: Add "G" suffix at the end of the model number to indicate Tray Packaging.

Part Number Explanation

0 R Q1 - C5 I V8 x
1 2 3 4 5 6 7

- 1---Through hole
- 2---RoHS 6, change "R" to "7" means RoHS 5
- 3---Series name, 1/4 Brick
- 4---Series code
- 5---Input range 48V wide (36-75V)
- 6---Output voltage (1.8V)
- 7---Suffix, Change "x" to "A" or "B" means with EMI shield;
Change "x" to "0" or "L" means without EMI shield.

ISOLATED DC/DC CONVERTERS

36 - 75 Vdc Input 1.8 Vdc /60 A Output



Feb. 21, 2011

Bel Power Inc., a subsidiary of Bel Fuse Inc.

Absolute Maximum Ratings

Parameter	Min	Typ	Max	Unit	Notes
Continuous Input Voltage	-0.3	-	80	V	Non-operating
Input Transient Voltage	-	-	100	V	100 mS maximum
Remote On/Off	-0.3	-	18	V	
I/O Isolation Voltage	-	-	1500	V	
Ambient Temperature	-40	-	85	°C	
Storage Temperature	-55	-	125	°C	

Note: All specifications are typical at 25 °C unless otherwise stated.

Input Specifications

Parameter	Min	Typ	Max	Unit	Notes
Operating Input Voltage	36	48	75	V	
Input Current (full load)	-	-	4	A	
Input Current (no load)	-	70	100	mA	
Remote Off Input Current	-	5	10	mA	
Input Reflected Ripple Current (pk-pk)	-	10	20	mA	With simulated source impedance of 10 uH, 5 Hz to 20 MHz; use a 100 uF/100 V electrolytic capacitor with ESR = 1 ohm max at 200 kHz
Input Reflected Ripple Current (rms)	-	2	7	mA	
I ² t Inrush Current Transient	-	-	1	A ² s	
Turn-on Voltage Threshold	32	34	35	V	
Turn-off Voltage Threshold	30	32	34	V	

CAUTION: This converter is not internally fused. An input line fuse must be used in application.

Recommend a fast-acting fuse with maximum rating of 5A on system board. Refer to the fuse manufacturer's datasheet for further information.

- Notes:** 1. This converter has internal C-L-C (0.47uF-2.2uH-6.6uF) filter.
2. All specifications are typical at 25 °C unless otherwise stated.

Output Specifications

Parameter	Min	Typ	Max	Unit	Notes
Output Voltage Set Point	1.764	1.8	1.836	V	Vin=48V, half load
Load Regulation	-	5	10	mV	Vin=48 V, Iout=0-60 A
Line Regulation	-	2	7	mV	Vin=36~75V, full load
Regulation Over Temperature (-40deg.C-85deg.C)	-	-	0.01	%Vo /C	
Ripple and Noise (pk-pk)	-	60	100	mV	Vin=48V, full load, 0-20MHz BW, with a 1µF ceramic capacitor and a 10µF tantalum capacitor at output
Ripple and Noise (rms)	-	15	30	mV	
Output Ripple and Noise(Pk-Pk) under worst case	-	-	150	mV	over all operating input voltage, load and ambient temperature condition
Output Current Range	0	-	60	A	

ISOLATED DC/DC CONVERTERS

36 - 75 Vdc Input 1.8 Vdc /60 A Output



Feb. 21, 2011

Bel Power Inc., a subsidiary of Bel Fuse Inc.

Output Specifications (continued)

Parameter	Min	Typ	Max	Unit	Notes	
Output DC Current Limit	65	75	85	A		
Rise time	-	-	15	mS		
Turn on Time	-	30	50	mS		
Overshoot at Turn on	-	0	3	%		
Output Capacitance	0	-	20,000	uF		
Transient Response						
ΔV50%~75% of Max Load	Overshoot	-	60	100	mV	di/dt=0.1A/us, Vin=48 Vdc, Ta=25 °C, with a 1μF ceramic capacitor and a 10uF Tantalum cap at output
	Settling Time	-	150	200	uS	
ΔV75%~50% of Max Load	Overshoot	-	60	100	mV	
	Settling Time	-	150	200	uS	

Note: All specifications are typical at nominal input, full load at 25°C unless otherwise stated.

General Specifications

Parameter	Min	Typ	Max	Unit	Notes
Efficiency	87	89	-	%	Vin=48V, full load
Switching Frequency	320	350	380	kHz	
Output Voltage Trim Range	80	-	110	%Vo	
Over Temperature Protection	-	120	130	°C	
Over Voltage Protection (Static)	2	-	2.5	V	This voltage is achieved by trimming up output slowly.
Over Voltage Protection (Dynamic)	-	-	2.8	V	The transient over voltage is achieved by connecting the Trim pin to Vout+ pin through a 1K resistor.
Weight	-	70	-	g	
FIT	TBD			-	Calculated Per Bell Core SR-332 (Vin=48 V, Vo=1.8V, Io=48A, Ta = 25°C, FIT=10 ⁹ /MTBF)
Dimensions	Inches (L × W × H)	2.34 x 1.51 x 0.55		-	0RQ1-C5TV8A & 0RQ1-C5TV8B
	Millimeters (L × W × H)	59.49 x 38.40 x 13.87			
Dimensions	Inches (L × W × H)	2.28 x 1.45 x 0.402		-	0RQ1-C5TV80 & 0RQ1-C5TV8L
	Millimeters (L × W × H)	57.88 x 36.83 x 10.21			
Isolation characteristics					
Input to Output	-	-	1500	Vdc	
Input to Case	-	-	1500	Vdc	
Output to Case	-	-	500	Vdc	
Isolation Resistance	10M	-	-	ohm	
Isolation Capacitance	-	1500	-	pF	

Note: All specifications are typical at 25 °C unless otherwise stated.

ISOLATED DC/DC CONVERTERS

36 - 75 Vdc Input 1.8 Vdc /60 A Output



Feb. 21, 2011

Bel Power Inc., a subsidiary of Bel Fuse Inc.

Efficiency Data

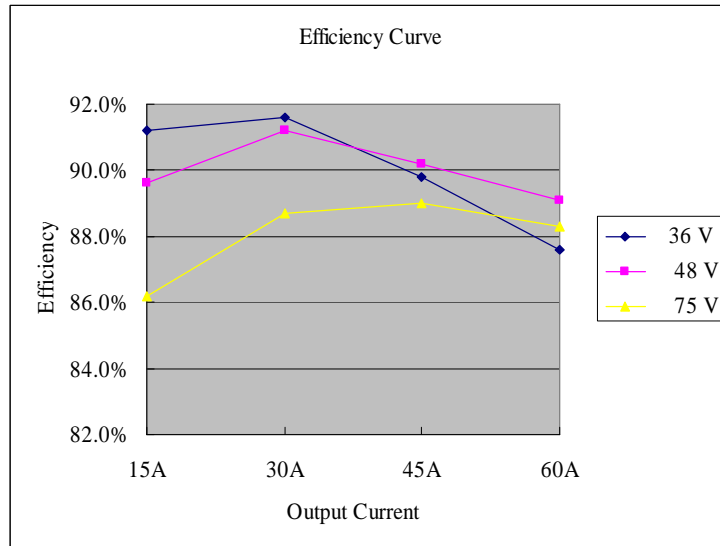

ISOLATED DC/DC CONVERTERS

36 - 75 Vdc Input 1.8 Vdc /60 A Output



Feb. 21, 2011

Bel Power Inc., a subsidiary of Bel Fuse Inc.

Remote On/Off

Parameter		Min	Typ	Max	Unit	Notes
Signal Low (Unit On)	Active Low	-0.3	-	0.8	V	The remote on/off pin open, Unit off.
Signal High (Unit Off)		2.4	-	18	V	
Signal Low (Unit Off)	Active High	-0.3	-	0.8	V	The remote on/off pin open, Unit on.
Signal High (Unit On)		2.4	-	18	V	
Current Sink		0	-	1	mA	

Recommended remote on/off circuit for active low

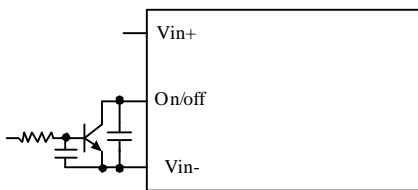

Control with open collector/drain circuit

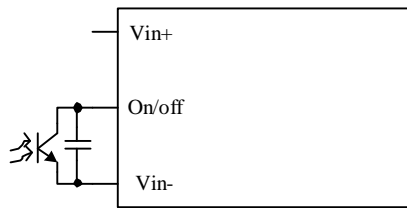

Control with photocoupler circuit

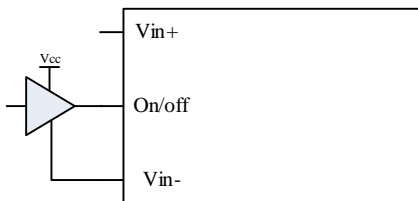

Control with logic circuit

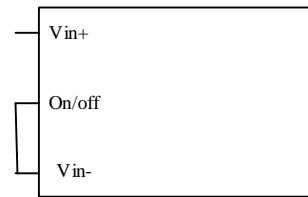

Permanently on

Recommended remote on/off circuit for active high

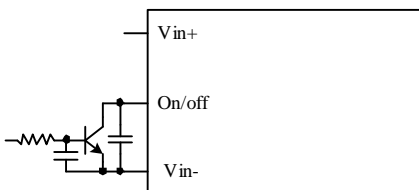

Control with open collector/drain circuit

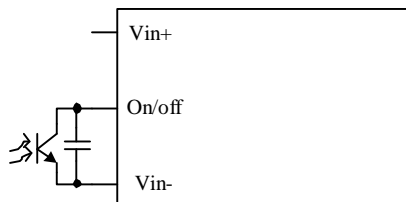

Control with photocoupler circuit

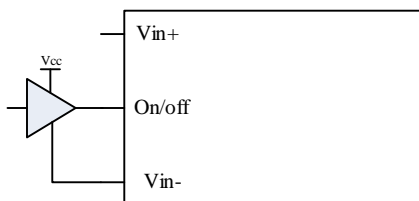

Control with logic circuit

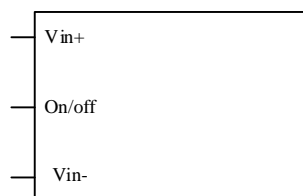

Permanently on

ISOLATED DC/DC CONVERTERS

36 - 75 Vdc Input 1.8 Vdc /60 A Output

bel

Feb. 21, 2011

Bel Power Inc., a subsidiary of Bel Fuse Inc.

Output Trim Equations

Equations for calculating the trim resistor are shown below. The Trim Down resistor should be connected between the Trim pin and Sense (-) pin. The Trim Up resistor should be connected between the Trim pin and the Sense (+). Only one of the resistors should be used for any given application.

Minimum trim down voltage is 1.44V

Maximum trim up voltage is 1.98V.

The total voltage increased by trim and remote sense should not exceed 10% of the nominal output voltage.

$$R_{trimdown} = \frac{511}{|\delta|} - 10.22 [k\Omega]$$

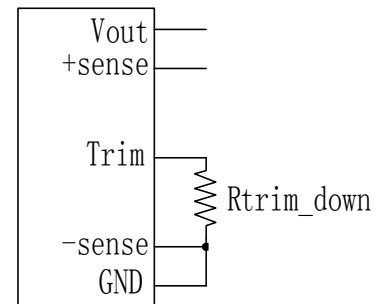

$$R_{trimup} = \frac{(100 + \delta) \cdot V_o \cdot 5.11 - 626}{1.225 \cdot \delta} - 10.22 [k\Omega]$$

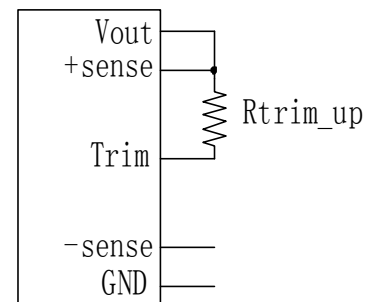

Note:
$$\delta = \frac{(V_{adj} - V_o)}{V_o} \times 100 [\%]$$

Vadj is the desired output voltage

V_o = 1.804V @I_{out}=0

ISOLATED DC/DC CONVERTERS

36 - 75 Vdc Input 1.8 Vdc /60 A Output

bel

Feb. 21, 2011

Bel Power Inc., a subsidiary of Bel Fuse Inc.

Remote Sense

This module has remote sense compensation feature. It can minimize the effects of resistance between module's output and load in system layout and facilitates accurate voltage regulation at load terminals or other selected point.

1. The remote sense lines carries very little current and hence do not require a large cross-sectional area.
2. This module compensates for a maximum drop of 10% of the nominal output voltage.
3. If the unit is already trimmed up, the available remote sense compensation range should be correspondingly reduced. The total voltage increased by trim and remote sense should not exceed 10% of the nominal output voltage.
4. When using remote sense compensation, all the resistance, parasitic inductance and capacitance of the system are incorporated within the feedback loop of this module. This can make an effect on the module's compensation, affecting the stability and dynamic response. A 0.1uF ceramic capacitor can be connected at the point of load to de-couple noise on the sense wires.
5. Recommend the connection of remote sense compensation as below figure. There are a resistor RS+ (10 ohm) from Vo+ to Sense+ and a resistor RS- (10 ohm) from Vo- to Sense- inside of this module.

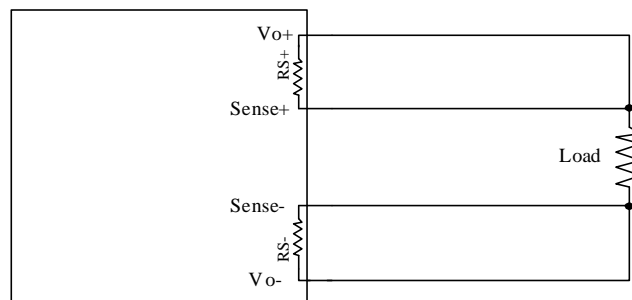

6. If not using remote sense compensation, please connect sense directly to output at module's pin, that is, connect sense+ to Vo+ and sense- to Vo- at module's pin, the shorter the better. See below figure.

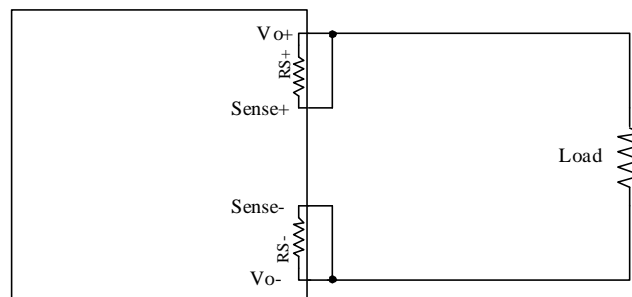

ISOLATED DC/DC CONVERTERS

36 - 75 Vdc Input 1.8 Vdc /60 A Output



Feb. 21, 2011

Bel Power Inc., a subsidiary of Bel Fuse Inc.

Over Current Protection

To provide protection in a fault output overload condition, the module is equipped with internal current-limiting circuitry and can endure current limiting for a few milli-seconds. If the over current condition persists beyond a few milliseconds, the module will shut down into hiccup mode and restart once every 210mS. The module operates normally when the output current goes into specified range. The typical average output current is 3A during hiccup.

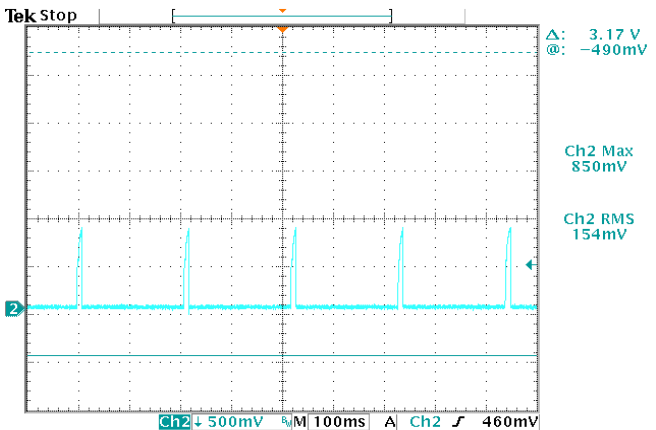

Vin=48V

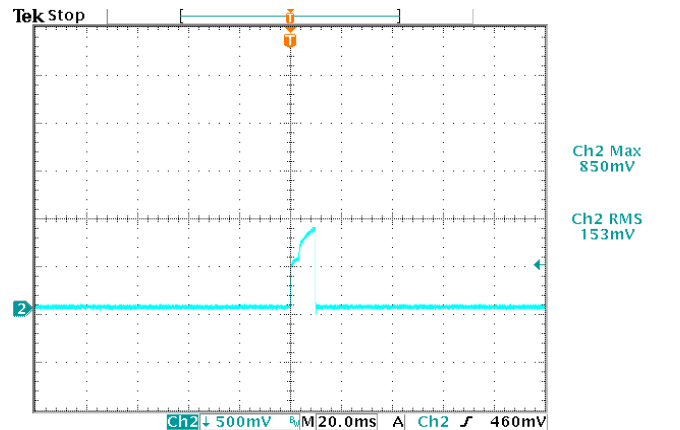

Expansion of on time portion

Over Voltage Protection

The output overvoltage protection consists of circuitry that monitors the voltage on the output terminals. If the voltage on the output terminals exceeds the over voltage protection threshold, the module will shutdown into hiccup mode and restart once every 350mS. The module operates normally when the fault is cleared.

Test setup:

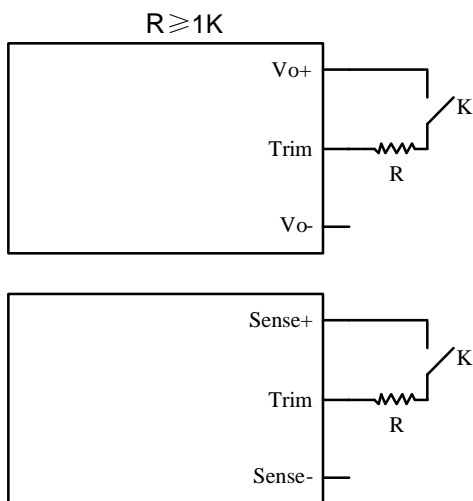

Waveform:

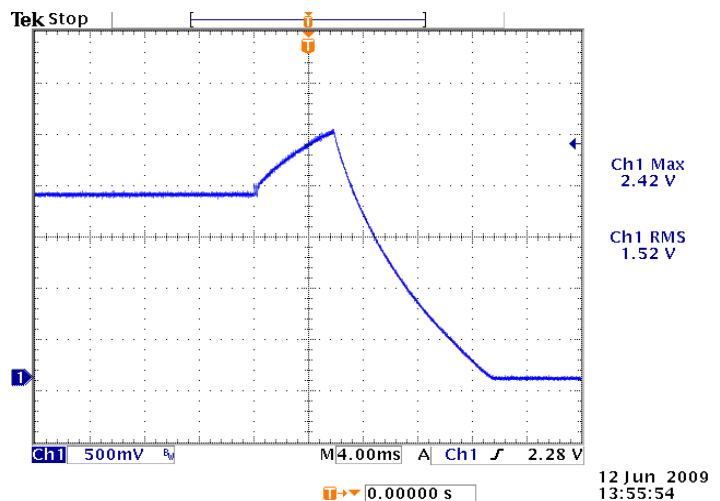

Vin=48V, Iout=5A

ISOLATED DC/DC CONVERTERS

36 - 75 Vdc Input 1.8 Vdc /60 A Output



Feb. 21, 2011

Bel Power Inc., a subsidiary of Bel Fuse Inc.

Over Temperature Protection

The OTP is achieved by thermistor R60 and the threshold is set at 120C in non-latch mode; the hottest component Q1 reaches 120C with 100LFM air flow correspondingly. It will restart automatically when the temperature falls down to 100C. The protecting point will be varied a little under different conditions (air flow, ambient temperature, input voltage, load...).

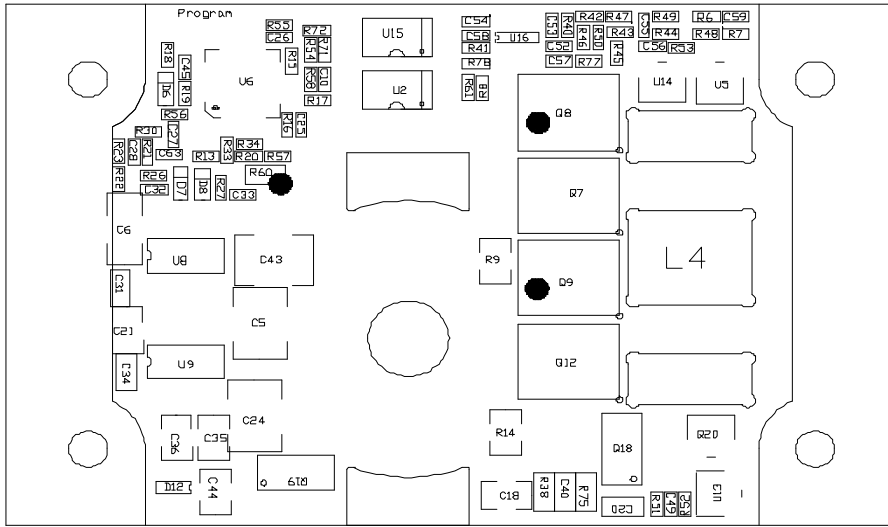

Input Under-voltage Lockout

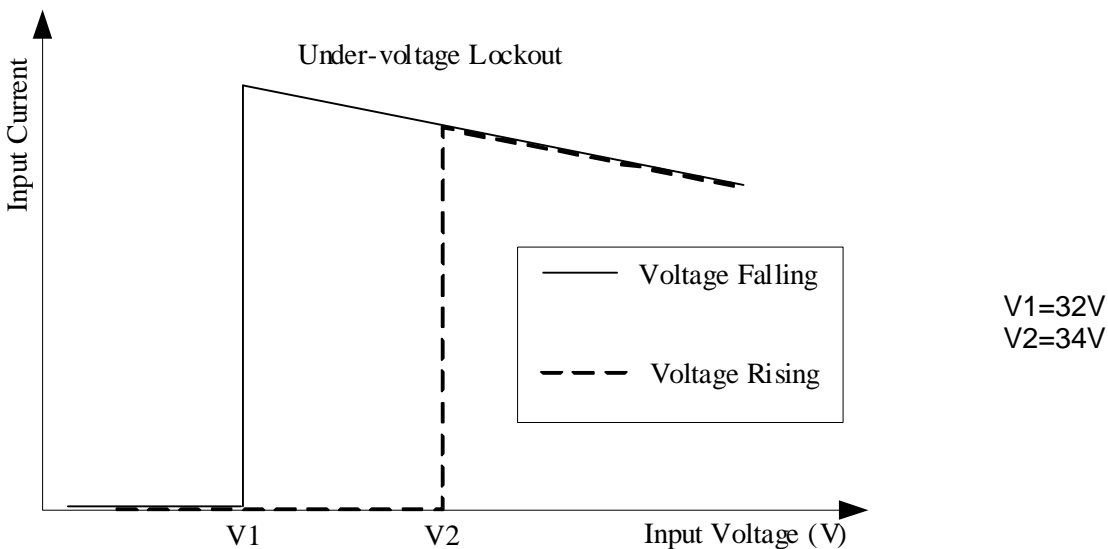

ISOLATED DC/DC CONVERTERS

36 - 75 Vdc Input 1.8 Vdc /60 A Output



Feb. 21, 2011

Bel Power Inc., a subsidiary of Bel Fuse Inc.

Ripple and Noise Waveforms

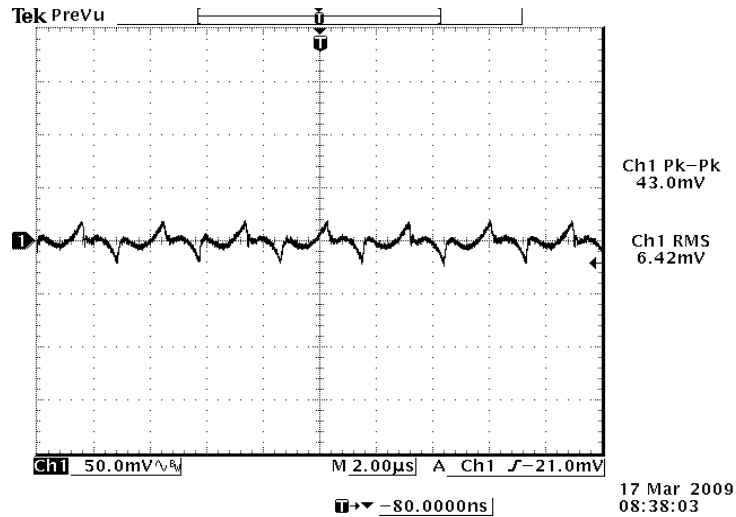

48Vdc input, 1.8Vdc/60A output

Note: Ripple and noise at full load, with a 1µF ceramic cap and a 10 µF Tantalum cap at output and Ta=25 deg C.

Transient Response Waveforms

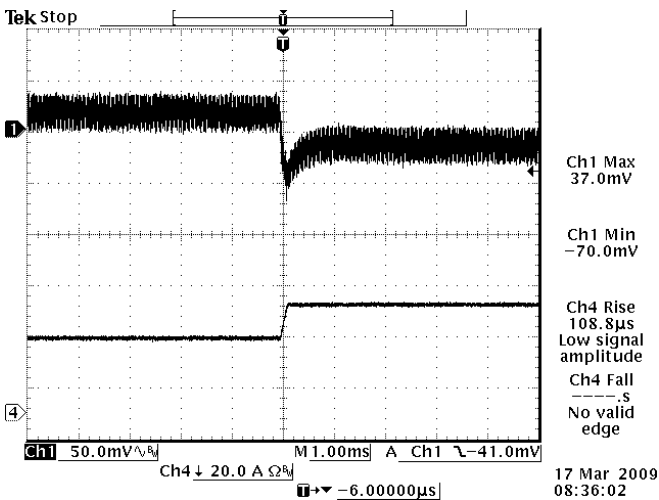

Vout=1.8V 50%-75% Load Transients at Vin=48V

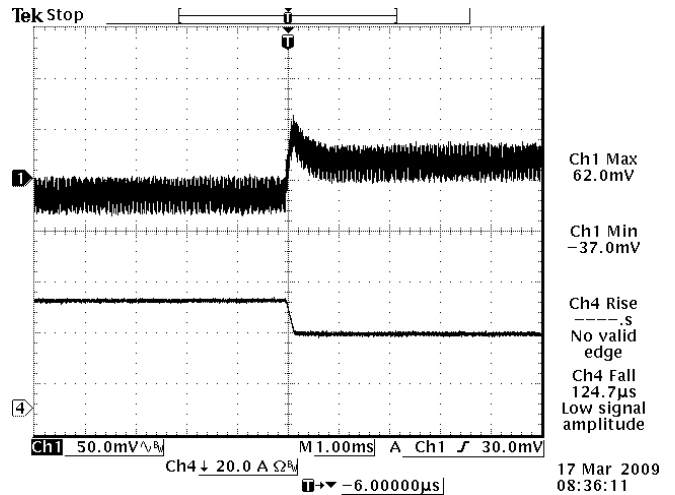

Vout=1.8V 75%-50% Load Transients at Vin=48V

Note: Transient response at di/dt=0.1A/µs, 1µF ceramic cap and 10µF aluminum cap at output and Ta=25 deg C.

ISOLATED DC/DC CONVERTERS

36 - 75 Vdc Input 1.8 Vdc /60 A Output



Feb. 21, 2011

Bel Power Inc., a subsidiary of Bel Fuse Inc.

Startup & Shutdown

Rise Time

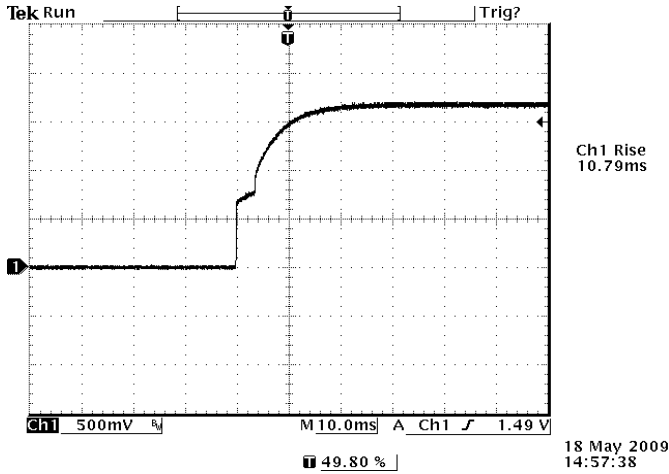

Vin=48V, Vo=1.8V, Io=60A

Shutdown

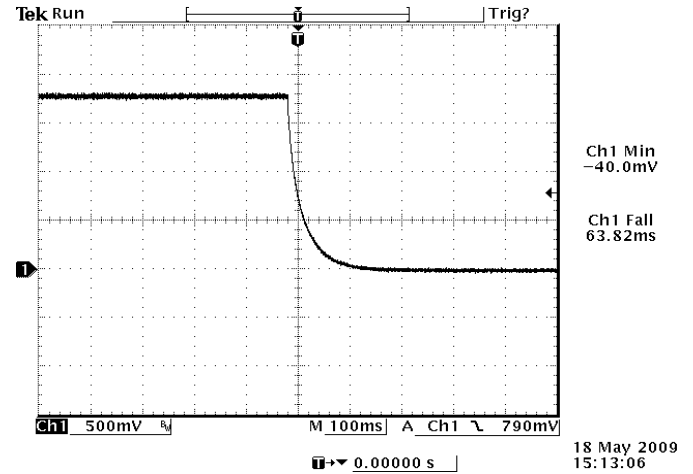

Vin=48V, Vo=1.2V, Io=60A

Startup time

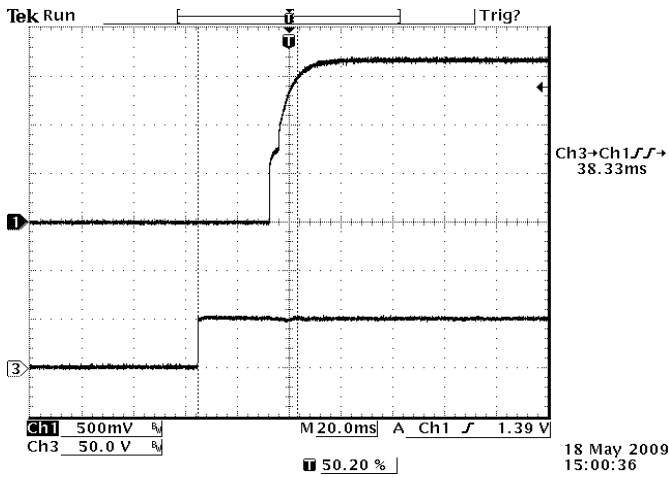

Startup from Vin
Ch1: Vo
Ch3: Vin
Vin=48V, Vo=1.2V, Io=60A

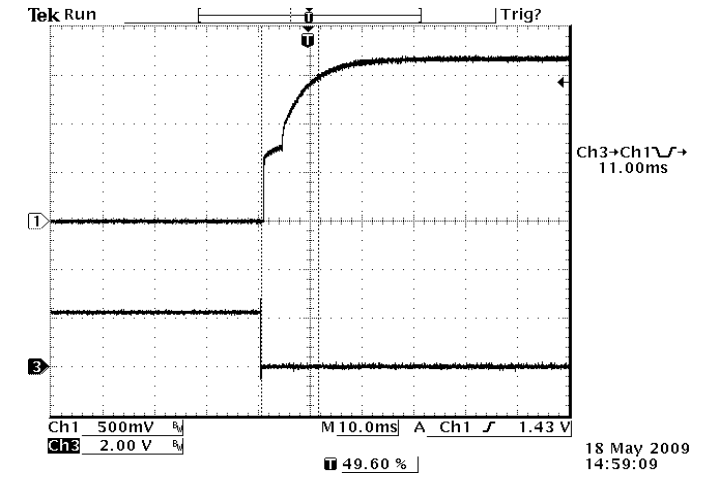

Startup from on/off
Ch1: Vo
Ch3: on/off
Vin=48V, Vo=1.2V, Io=60A

ISOLATED DC/DC CONVERTERS

36 - 75 Vdc Input 1.8 Vdc /60 A Output



Feb. 21, 2011

Bel Power Inc., a subsidiary of Bel Fuse Inc.

Thermal Derating Curve

Maximum junction temperature of semiconductors derated to 120 degree C.

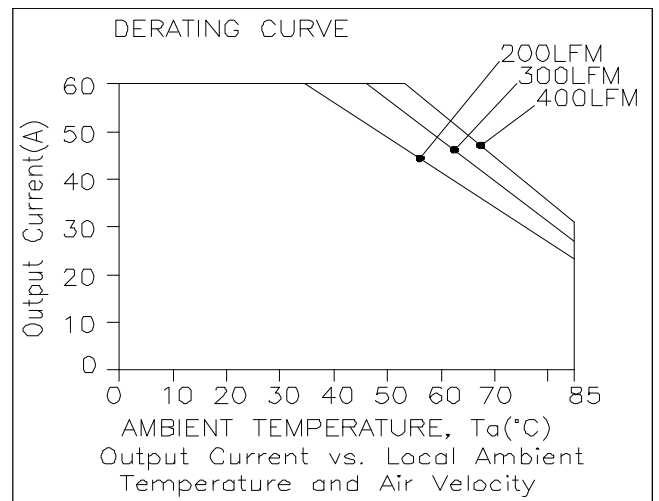
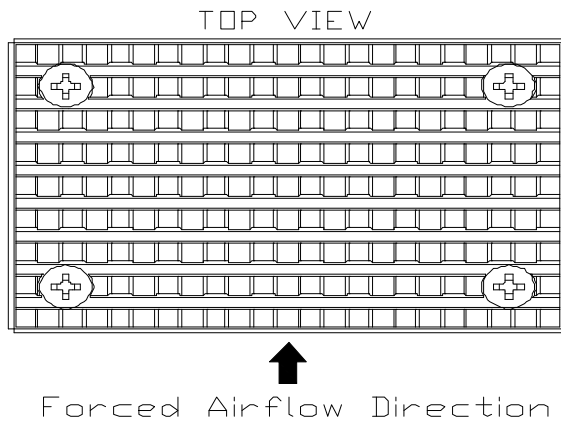

Derating curve under normal input

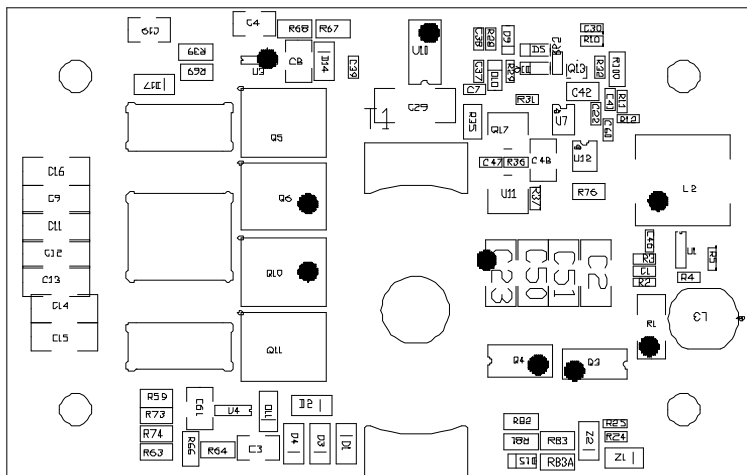

Temperature reference points on top side

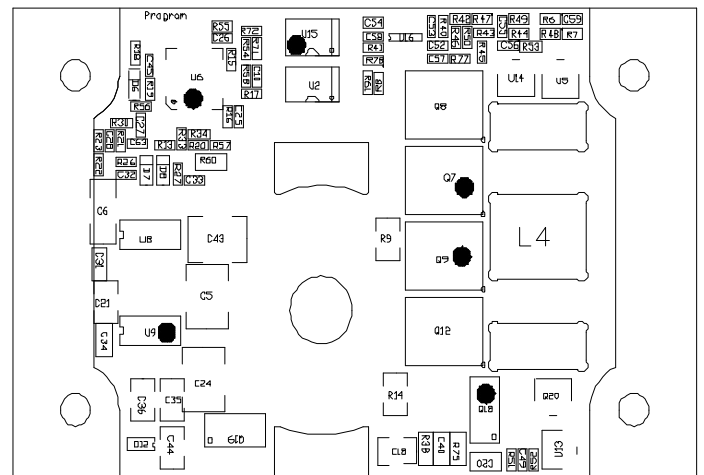

Temperature reference points on bottom side

ISOLATED DC/DC CONVERTERS

36 - 75 Vdc Input 1.8 Vdc /60 A Output



Feb. 21, 2011

Bel Power Inc., a subsidiary of Bel Fuse Inc.

Safety & EMC

Safety

1. Material flammability UL94V-0
2. TUV Certification EN60950-1
3. UL Certification UL60950-1

EMC

1. Surge IEC61000-4-5
2. DC-DIP IEC61000-4-29
3. Conductive EMI EN55022 class A

Compliance to EN55022 class A (both q.peak and average) with the following inductive and capacitive filter

Setup:

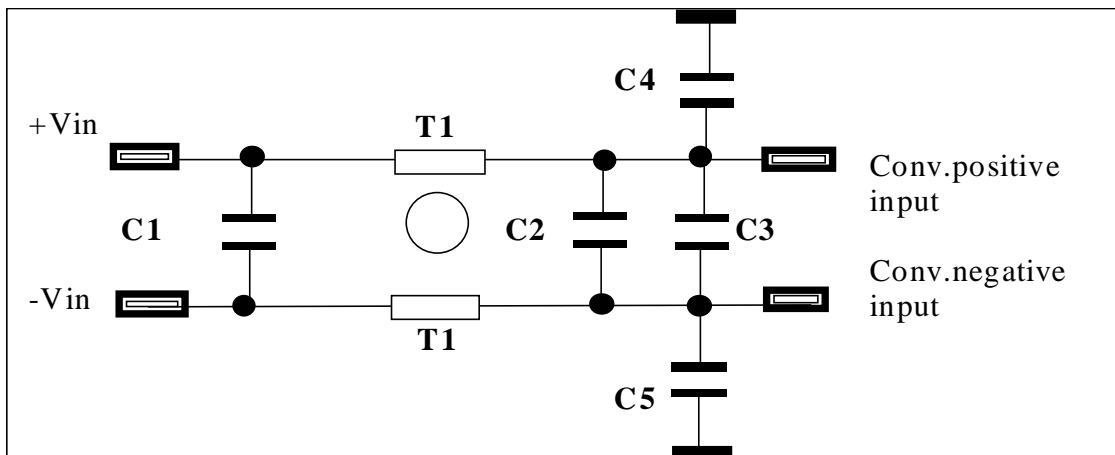

Item	Designator	Parameter	Vendor	Vendor P/N
1	C1	1uF/100V, ceramic	Murata	GRM32ER72A105KA01L
2	C2	0.1uF/100V, ceramic	TDK	C3216X7R2A104K
3	C3	100uF/100V, AL cap	Nichicon	UVZ2A101MPD
4	C4	2200pF/2000V, ceramic	Johanson	631R15W222KV4TE
5	C5	2200pF/2000V, ceramic	Johanson	631R15W222KV4TE
6	T1	1.3mH, common mode	Pulse	P0402NL

ISOLATED DC/DC CONVERTERS

36 - 75 Vdc Input 1.8 Vdc /60 A Output



Feb. 21, 2011

Bel Power Inc., a subsidiary of Bel Fuse Inc.

Safety & EMC (continued)

Positive

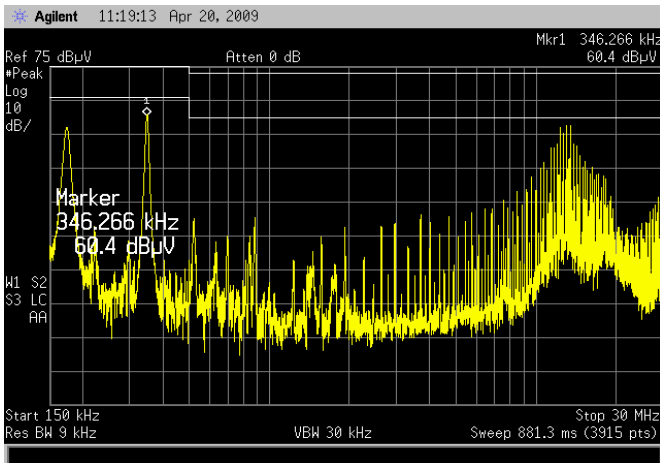

Negative

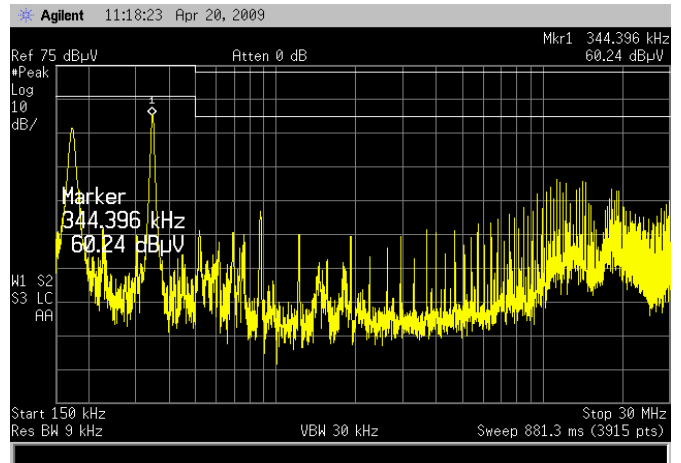

Layout

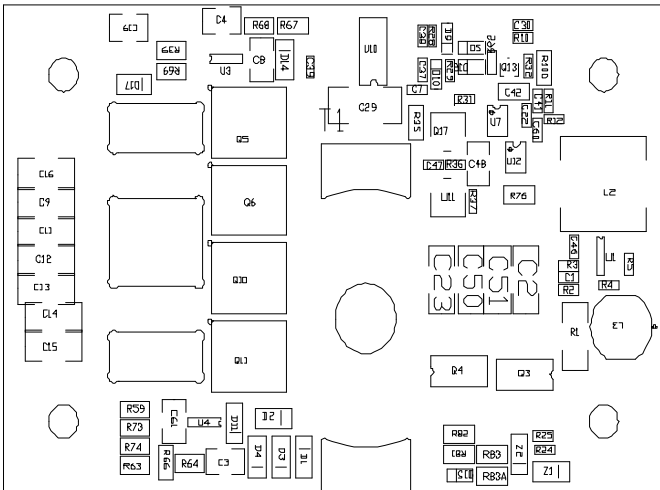

Layout of components on top side

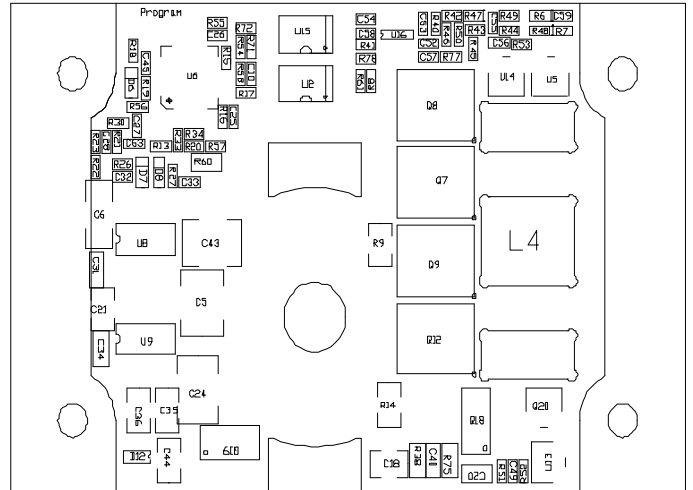

Layout of components on bottom side

ISOLATED DC/DC CONVERTERS

36 - 75 Vdc Input 1.8 Vdc /60 A Output



Feb. 21, 2011

Bel Power Inc., a subsidiary of Bel Fuse Inc.

Mechanical Outline

0RQ1-C5TV8A and 0RQ1-C5TV8B

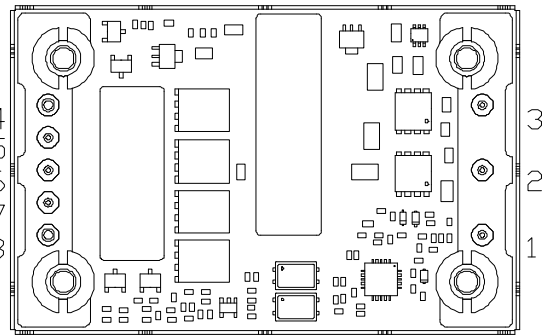
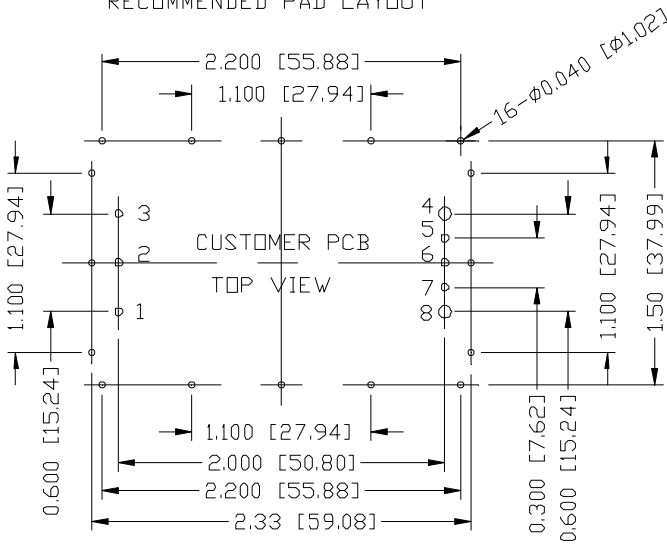
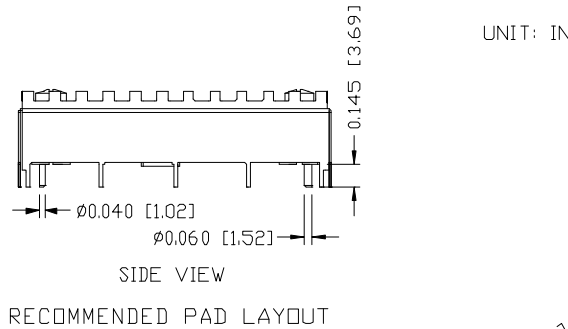
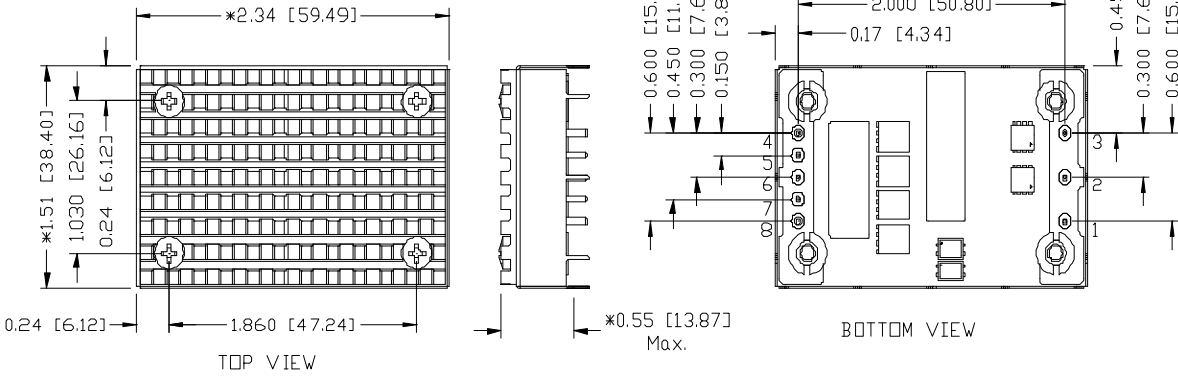

Pin Connections

Pin	Function	Pin Size
1	Vin(-)	0.040"
2	On/Off	0.040"
3	Vin(+)	0.040"
4	Vo(+)	0.060"
5	Sense(+)	0.040"
6	Trim	0.040"
7	Sense(-)	0.040"
8	Vo(-)	0.060"

Notes: 1. Pin 5 must be connected to Vo(+).
2. Pin 7 must be connected to Vo(-).

1,2,3,5,6,7 ϕ 0.047 HOLE SIZE, ϕ 0.08 min PAD SIZE
4,8 ϕ 0.07 HOLE SIZE, ϕ 0.10 min PAD SIZE

ISOLATED DC/DC CONVERTERS

36 - 75 Vdc Input 1.8 Vdc /60 A Output



Feb. 21, 2011

Bel Power Inc., a subsidiary of Bel Fuse Inc.

Mechanical Outline

0RQ1-C5TV80 and 0RQ1-C5TV8L

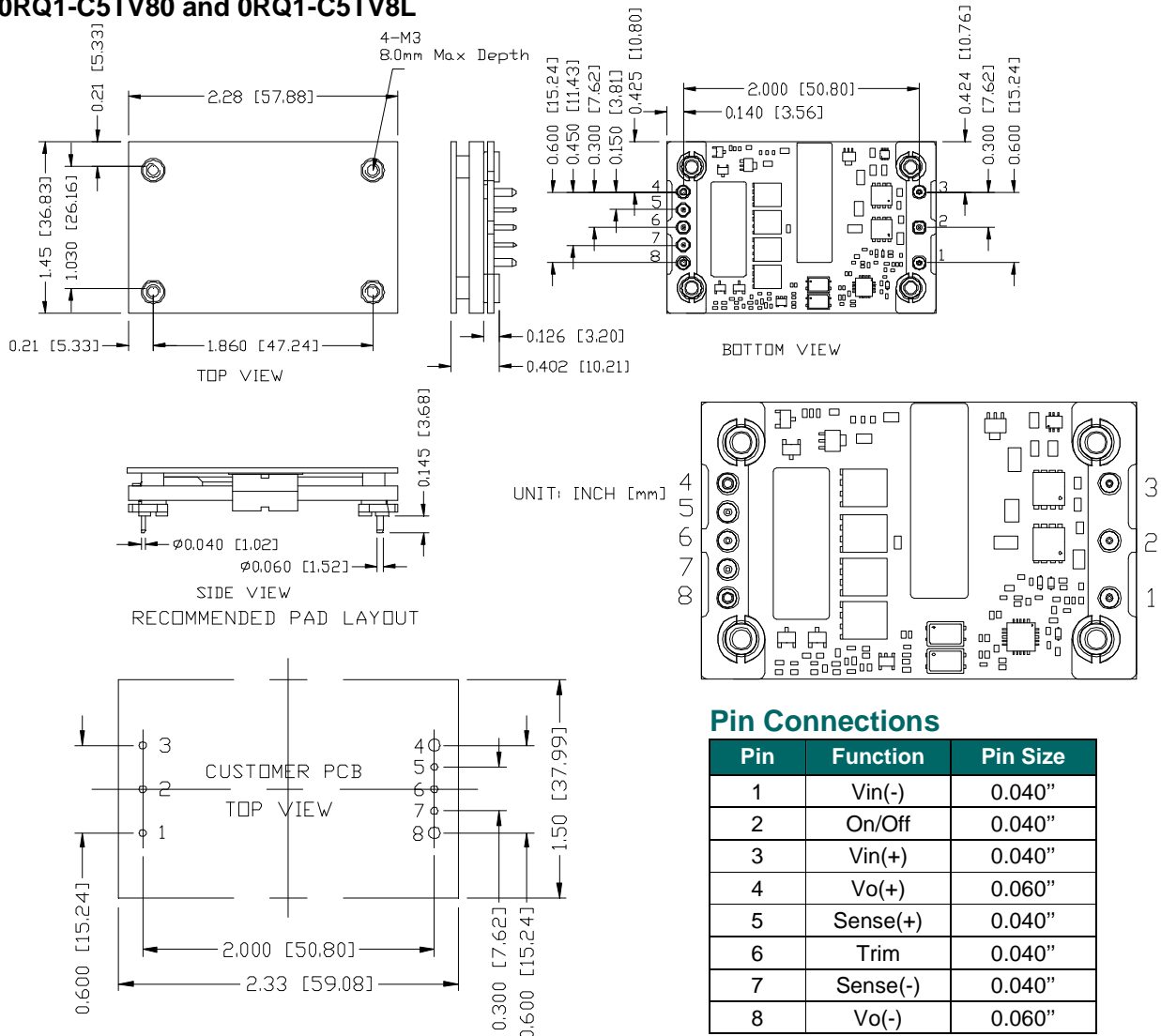

Pin Connections

Pin	Function	Pin Size
1	Vin(-)	0.040"
2	On/Off	0.040"
3	Vin(+)	0.040"
4	Vo(+)	0.060"
5	Sense(+)	0.040"
6	Trim	0.040"
7	Sense(-)	0.040"
8	Vo(-)	0.060"

Notes: 1. Pin 5 must be connected to Vo(+).
2. Pin 7 must be connected to Vo(-).

1,2,3,5,6,7 ϕ 0.047 HOLE SIZE, ϕ 0.08 min PAD SIZE
4,8 ϕ 0.07 HOLE SIZE, ϕ 0.10 min PAD SIZE

Note: This module is recommended and compatible with Pb-Free Wave Soldering and must be soldered using a peak solder temperature of no more than 260 °C for less than 5 seconds.

Note:

- 1) All Pins: Material - Copper Alloy;
Finish – 3 micro inches minimum Gold over 50 micro inches minimum Nickel plate.
- 2) Undimensioned components are shown for visual reference only.
- 3) All dimensions in inches (mm); Tolerances: x.xx +/-0.02 in. (x.x +/-0.5mm) x.xxx +/-0.010 in. (x.xx +/-0.25mm).

ISOLATED DC/DC CONVERTERS

36 - 75 Vdc Input 1.8 Vdc /60 A Output



Feb. 21, 2011

Bel Power Inc., a subsidiary of Bel Fuse Inc.

Revision History

Date	Revision	Changes Detail	Approval
2008-09-19	PA	First release	YP Zhou
2008-12-02	PB	Update mechanical drawing.	YP Zhou
2009-05-06	PC	1. Update efficiency. 2. Add mechanical drawing, efficiency data, ripple and transients' wave and the derating curve.	YP Zhou
2010-01-27	D	1. Update the max value of continuous input voltage from 75V to 80V. 2. Update the no load input current from 180mA to 100mA. 3. Update the max value of line regulation from 5mV to 7mV.	JZ Wang
2011-02-21	E	Change the max height of 0RQ1-C5TV8A & 0RQ1-C5TV8B from 0.53 inch to 0.55 inch.	JZ Wang

RoHS Compliance

Complies with the European Directive 2002/95/EC, calling for the elimination of lead and other hazardous substances from electronic products.



©2011 Bel Fuse Inc. Specifications subject to change without notice. 022111

17

CORPORATE

Bel Fuse Inc.
206 Van Vorst Street
Jersey City, NJ 07302
Tel 201-432-0463
Fax 201-432-9542
www.belfuse.com

FAR EAST

Bel Fuse Ltd.
8F/ 8 Luk Hop Street
San Po Kong
Kowloon, Hong Kong
Tel 852-2328-5515
Fax 852-2352-3706
www.belfuse.com

EUROPE

Bel Fuse Europe Ltd.
Preston Technology Management Centre
Marsh Lane, Suite G7, Preston
Lancashire, PR1 8UD, U.K.
Tel 44-1772-556601
Fax 44-1772-888366
www.belfuse.com