

ISOLATED DC/DC CONVERTERS

48 Vdc Input 12 Vdc/12 A, 3.3 Vdc/46 A, 5 Vdc/30 A, 1.2-2.5 Vdc/50 A Outputs



0RQB-C5T Series

RoHS Compliant

Rev.A

- Isolated
- High Efficiency
- High Power Density
- Low Cost
- Input Under Voltage Lockout
- Fixed Frequency (330 kHz)
- Active Low/High (Option)
- UL60950 Recognized (UL/cUL)
- Output Over Voltage Shutdown
- OCP/SCP
- Over Temperature Protection
- Remote On/Off
- Output Voltage Trim
- Positive/Negative Remote Sense
- Input Over Voltage Lockout
- Basic Isolation



Description

The 0RQB-C5T Series are isolated dc/dc converters that operate from a nominal 48 Vdc source. These units will provide up to 150 W of output power from a nominal 48 Vdc input. These units are designed to be highly efficient and low cost. Typical efficiency of 12 Vdc output at 48 Vdc input at full load is 93%. Features include remote on/off, over current protection and under-voltage lockout. These converters are provided in an industry standard quarter brick package.

Part Selection

Output Voltage	Input Voltage	Max. Output Current	Max. Output Power	Typical Efficiency	Model Number Active High	Model Number Active Low
12 V	36 V - 75 V	12 A	144 W	93.0%	0RQB-C5T120	0RQB-C5T12L
5.0 V	36 V - 75 V	30 A	150 W	92.5%	0RQB-C5T050	0RQB-C5T05L
3.3 V	36 V - 75 V	46 A	152 W	91.0%	0RQB-C5T033	0RQB-C5T03L
2.5 V	36 V - 75 V	50 A	125 W	90.5%	0RQB-C5T025	0RQB-C5T02L
1.8 V	36 V - 75 V	50 A	90 W	88.0%	0RQB-C5TV80	0RQB-C5TV8L
1.5 V	36 V - 75 V	50 A	75 W	85.0%	0RQB-C5TV50	0RQB-C5TV5L
1.2 V	36 V - 75 V	50 A	60 W	83.0%	0RQB-C5TV20	0RQB-C5TV2L

- Notes:** 1. Add "G" suffix at the end of the model number to indicate Tray Packaging.
2. All part numbers above indicate RoHS 6. Change the second letter "R" to "7" for RoHS 5 part numbers.

Absolute Maximum Ratings

Parameter	Min	Typ	Max	Notes
Input Voltage (continuous)	-0.3 V	-	80 V	
Remote On/Off	-0.3 V	-	18 V	
I/O Isolation Voltage	-	-	2000 V	
Ambient Temperature	-40 °C	-	85 °C	
Storage Temperature	-55 °C	-	125 °C	

Note: All specifications are typical at nominal input, full load at 25 °C unless noted.

ISOLATED DC/DC CONVERTERS

48 Vdc Input 12 Vdc/12 A, 3.3 Vdc/46 A, 5 Vdc/30 A, 1.2-2.5 Vdc/50 A Outputs



Input Specifications

Parameter	Min	Typ	Max	Notes
Input Voltage	36 V	48 V	75 V	
Input Current (full load)				
Vo=12 V	-	-	4.5 A	
Vo=5.0 V	-	-	4.9 A	
Vo=3.3 V	-	-	4.9 A	
Vo=2.5 V	-	-	4.1 A	
Vo=1.8 V	-	-	3.0 A	
Vo=1.5 V	-	-	2.6 A	
Vo=1.2 V	-	-	2.1 A	
Input Current (no load)	-	120 mA	180 mA	
Remote Off Input Current		10 mA	15 mA	
Input Reflected Ripple Current (pk-pk)	-	10 mA	15 mA	Tested with simulated source impedance of 10 uH, 5 Hz to 20 MHz; use a 100 uF /100 V electrolytic capacitor with ESR = 1 ohm max. at 200 kHz at 25 °C.
Input Reflected Ripple Current (rms)	-	1.5 mA	3 mA	
I ² t Inrush Current Transient	-	0.05 A ² s	0.1 A ² s	
Turn-on Voltage Threshold	32 V	34 V	35 V	
Turn-off Voltage Threshold	30 V	32 V	34 V	
Input over voltage Lockout	76 V	78 V	80 V	

Note: All specifications are typical at nominal input, full load at 25 °C unless noted.

Output Specifications

Parameter	Min	Typ	Max	Notes
Output Voltage Set Point				Vin=48 V, Io=50% full load
Vo=12 V	11.790 V	12.030 V	12.270 V	
Vo=5.0 V	4.925 V	5.004 V	5.075 V	
Vo=3.3 V	3.260 V	3.308 V	3.360 V	
Vo=2.5 V	2.450 V	2.503 V	2.550 V	
Vo=1.8 V	1.770 V	1.808 V	1.844 V	
Vo=1.5 V	1.477 V	1.500 V	1.523 V	
Vo=1.2 V	1.176 V	1.200 V	1.224 V	
Line Regulation				
Vo=12 V	-	±8 mV	±15 mV	
Vo=5.0 V	-	±5 mV	±15 mV	
Vo=1.2 V-3.3 V	-	±3 mV	±6 mV	
Load Regulation				
Vo=5.0 V-12 V	-	±10 mV	±20 mV	
Vo=2.5 V-3.3 V	-	±5 mV	±10 mV	
Vo=1.2 V-1.8 V	-	±2 mV	±5 mV	
Regulation Over Temperature (-40 °C to +85 °C)				
Vo=12 V	-	±60 mV	±100 mV	
Vo=5.0 V	-	±40 mV	±65 mV	
Vo=3.3 V	-	±30 mV	±50 mV	
Vo=2.5 V	-	±20 mV	±40 mV	
Vo=1.8 V-1.2 V	-	±15 mV	±30 mV	
Output Current				
Vo=12 V	0 A	-	12 A	
Vo=5.0 V	0 A	-	30 A	
Vo=3.3 V	0 A	-	46 A	
Vo=1.2 V-2.5 V	0 A	-	50 A	

ISOLATED DC/DC CONVERTERS

48 Vdc Input 12 Vdc/12 A, 3.3 Vdc/46 A, 5 Vdc/30 A, 1.2-2.5 Vdc/50 A Outputs



Output Specifications (continued)

Parameter		Min	Typ	Max	Notes	
Current Limit Threshold	Vo=12 V	14 A	15.5 A	18 A		
	Vo=5.0 V	35 A	40 A	45 A		
	Vo=3.3 V	50 A	60 A	65 A		
	Vo=1.2 V-2.5 V	55 A	60 A	65 A		
Short Circuit Surge Transient		-	3 A ² s	5 A ² s		
Ripple and Noise (rms)	Vo=12 V	-	25 mV	30 mV	Test conditions: 0-20 MHz BW, with a 1 uF ceramic capacitor and a 10 uF Tantalum capacitor at the output.	
	Vo=5.0 V	-	20 mV	25 mV		
	Vo=3.3 V	-	20 mV	20 mV		
	Vo=1.2 V-2.5 V	-	15 mV	20 mV		
Ripple and Noise (pk-pk)	Vo=12 V	-	70 mV	90 mV		
	Vo=5.0 V	-	60 mV	80 mV		
	Vo=3.3 V	-	50 mV	70 mV		
	Vo=1.8 V	-	45 mV	60 mV		
	Vo=2.5 V	-	40 mV	60 mV		
	Vo=1.5 V	-	55 mV	70 mV		
	Vo=1.2 V	-	40 mV	60 mV		
Turn on Time		10 mS	-	100 mS		
Overshoot at Turn on		-	0%	5%		
Output Capacitance	Vo=12.0 V	0 uF	-	2200 uF		
	Vo=5.0 V	0 uF	-	10000 uF		
	Vo=1.2 V-3.3 V	0 uF	-	20000 uF		
Transient Response						
50% ~ 75% Max Load	Overshoot	Vo=12.0 V	-	600 mV	800 mV	Test conditions: di/dt = 0.1 A/uS, Vin=48 V, with a 1 uF ceramic capacitor and a 10 uF Tantalum capacitor at the output.
	Settling Time		-	200 uS	300 uS	
75% ~ 50% Max Load	Overshoot	Vo=12.0 V	-	600 mV	800 mV	
	Settling Time		-	200 uS	300 uS	
50% ~ 75% Max Load	Overshoot	Vo=5.0 V	-	250 mV	375 mV	
	Settling Time		-	100 uS	200 uS	
75% ~ 50% Max Load	Overshoot	Vo=5.0 V	-	250 mV	375 mV	
	Settling Time		-	100 uS	200 uS	
50% ~ 75% Max Load	Overshoot	Vo=3.3 V	-	100 mV	200 mV	
	Settling Time		-	200 uS	300 uS	
75% ~ 50% Max Load	Overshoot	Vo=3.3 V	-	100 mV	200 mV	
	Settling Time		-	200 uS	300 uS	
50% ~ 75% Max Load	Overshoot	Vo=2.5 V	-	100 mV	200 mV	
	Settling Time		-	300 uS	400 uS	
75% ~ 50% Max Load	Overshoot	Vo=2.5 V	-	100 mV	200 mV	
	Settling Time		-	300 uS	400 uS	
50% ~ 75% Max Load	Overshoot	Vo=1.8 V	-	100 mV	140 mV	
	Settling Time		-	200 uS	300 uS	
75% ~ 50% Max Load	Overshoot	Vo=1.5 V	-	100 mV	140 mV	
	Settling Time		-	200 uS	300 uS	
50% ~ 75% Max Load	Overshoot	Vo=1.2 V	-	100 mV	120 mV	
	Settling Time		-	200 uS	300 uS	
75% ~ 50% Max Load	Overshoot	Vo=1.2 V	-	100 mV	120 mV	
	Settling Time		-	200 uS	300 uS	

Note: All specifications are typical at nominal input, full load at 25 °C unless noted.

ISOLATED DC/DC CONVERTERS

48 Vdc Input 12 Vdc/12 A, 3.3 Vdc/46 A, 5 Vdc/30 A, 1.2-2.5 Vdc/50 A Outputs



General Specifications

Parameter	Min	Typ	Max	Notes	
Efficiency	Vo=12 V	90%	93%	-	Vin=48 V, full load, Ta=25 °C
	Vo=5.0 V	89%	92.5%	-	
	Vo=3.3 V	88%	91%	-	
	Vo=2.5 V	87%	90.5%	-	
	Vo=1.8 V	85%	88%	-	
	Vo=1.5 V	82%	85%	-	
	Vo=1.2 V	80%	83%	-	
Switching Frequency	280 kHz	330 kHz	380 kHz		
Isolation capacitance	-	1500 pF	-		
Input to Output Isolation Voltage	-	-	2000 V		
Remote Sense Compensation	-	-	10% Vo	The total voltage increased by trim and remote sense should not exceed 10%Vo.	
Output Voltage Trim Range	80% Vo	-	110% Vo		
Over Temperature Protection	-	125 °C	-		
Over Voltage Protection	-	130% Vo	-	Vin=48V, full load, Hiccup mode	
MTBF	1,109,917 hours			Calculated Per Bell Core SR-332 (Io =80% load, Vin=48 V, Vo=3.3 V; Ta = 25 °C)	
Dimensions	Inches	2.30 x 1.45 x 0.395			
	millimeters	58.42 x 36.83 x 10.03			
Weight	-	41 g	-		

Note: All specifications are typical at nominal input, full load at 25 °C unless noted.

Control Specifications

Parameter	Min	Typ	Max	Notes	
Remote On/Off					
Signal Low (Unit On)	Active Low	-0.3 V	-	0.8 V	0RQB-C5TxxL. The remote on/off pin open, Unit off.
Signal High (Unit Off)		2.4 V	-		
Signal Low (Unit Off)	Active High	-0.3 V	-	0.8 V	0RQB-C5Txx0. The remote on/off pin open, Unit on.
Signal High (Unit On)		2.4 V	-		
Current Sink	0 mA	-	0.75 mA		

ISOLATED DC/DC CONVERTERS

48 Vdc Input 12 Vdc/12 A, 3.3 Vdc/46 A, 5 Vdc/30 A, 1.2-2.5 Vdc/50 A Outputs

bel
POWER PRODUCTS

Output Trim Equations

Equations for calculating the trim resistor are shown below (Unit: kΩ). The Trim Down resistor should be connected between the Trim pin and Ground pin. The Trim Up resistor should be connected between the Trim pin and the Vout. Only one of the resistors should be used for any given application.

1) For $V_o=1.5\text{ V} - 12\text{ V}$:

$$R_{trimdown} = \frac{511}{|\delta|} - 10.22$$

$$R_{trimup} = \frac{(100 + \delta) \cdot V_o \cdot 5.11 - 626}{1.225 \cdot \delta} - 10.22$$

Note:

$$\delta = \frac{(V_{o_req} - V_o)}{V_o} \times 100[\%]$$

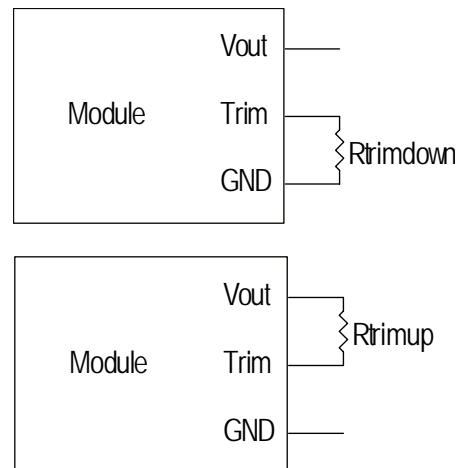

V_{o_req} =Desired (trimmed) output voltage [V]; V_o =output voltage
 $V_o=12.004\text{ V}$ for 12 V output; $V_o=5\text{ V}$ for 5.004 V output; $V_o=3.308\text{ V}$ for 3.3 V output; $V_o=2.503\text{ V}$ for 2.5 V output; $V_o=1.808\text{ V}$ for 1.8 V output; $V_o=1.503\text{ V}$ for 1.5 V output

2) For $V_o=1.2\text{ V}$:

$$R_{trimdown} = \frac{511}{|\delta|} - 10.22$$

$$R_{trimup} = \frac{(100 + \delta) \cdot V_o \cdot 5.11 - 313}{0.6125 \cdot \delta} - 10.22$$

Note:

$$\delta = \frac{(V_{o_req} - V_o)}{V_o} \times 100[\%]$$

V_{o_req} =Desired (trimmed) output voltage [V]; V_o =output voltage
 $V_o=1.202\text{ V}$ for 1.2 V output

ISOLATED DC/DC CONVERTERS

48 Vdc Input 12 Vdc/12 A, 3.3 Vdc/46 A, 5 Vdc/30 A, 1.2-2.5 Vdc/50 A Outputs



Efficiency Data

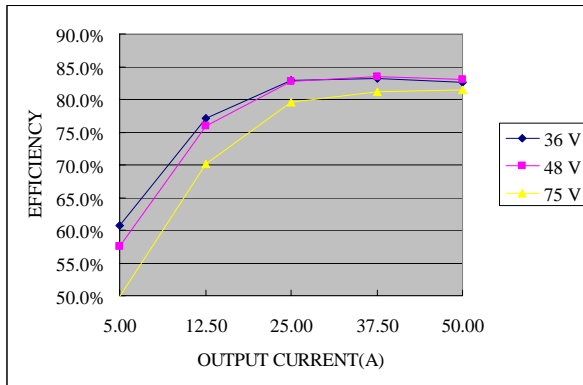

0RQB-C5TV2x

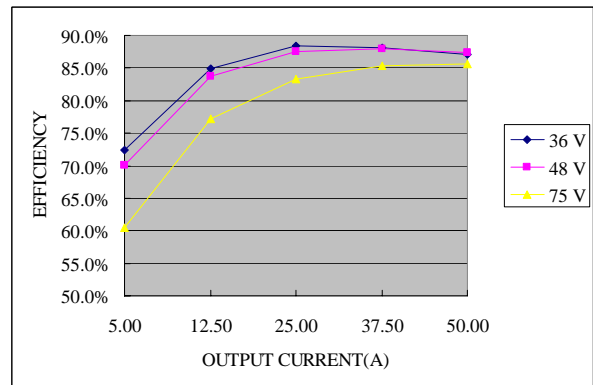

0RQB-C5TV5x

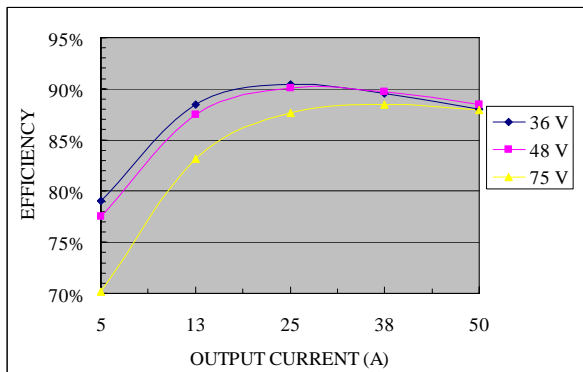

0RQB-C5TV8x

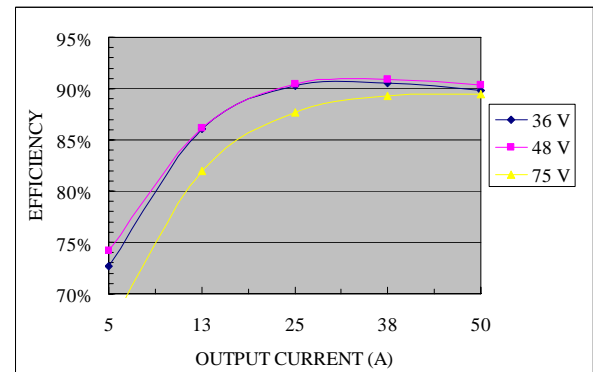

0RQB-C5T02x

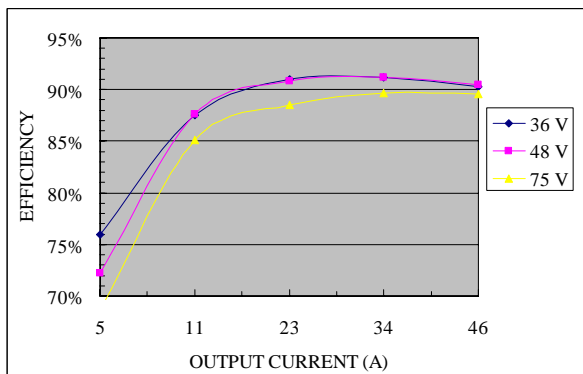

0RQB-C5T03x

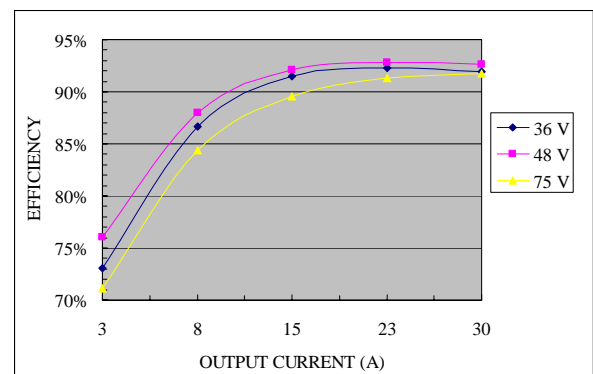

0RQB-C5T05x

ISOLATED DC/DC CONVERTERS

48 Vdc Input 12 Vdc/12 A, 3.3 Vdc/46 A, 5 Vdc/30 A, 1.2-2.5 Vdc/50 A Outputs



Efficiency Data (continued)

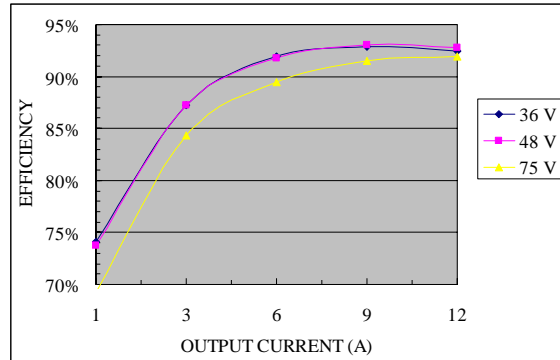

0RQB-C5T12x

Thermal Derating Curves

Vin=48V, with maximum junction temperature of semiconductors derated to 120 degree C.

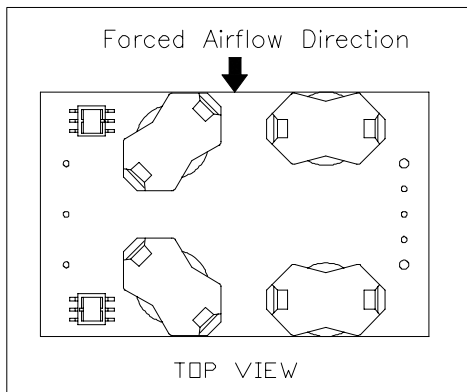

0RQB-C5Txxx

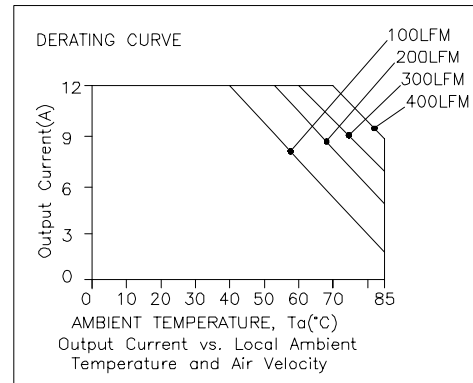

0RQB-C5T12x

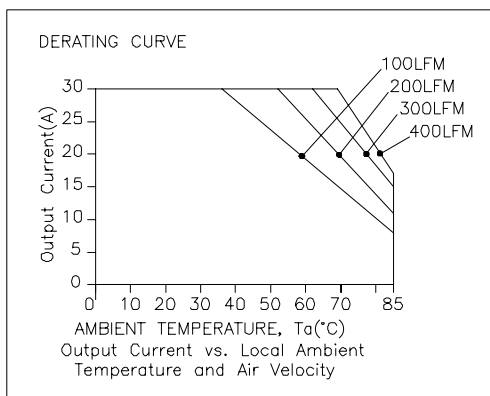

0RQB-C5T05x

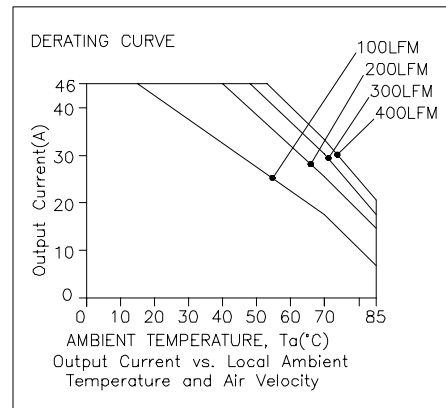

0RQB-C5T03x

ISOLATED DC/DC CONVERTERS

48 Vdc Input 12 Vdc/12 A, 3.3 Vdc/46 A, 5 Vdc/30 A, 1.2-2.5 Vdc/50 A Outputs



Thermal Derating Curves (continued)

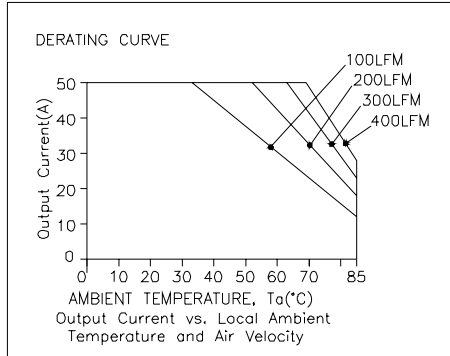

0RQB-C5T02x

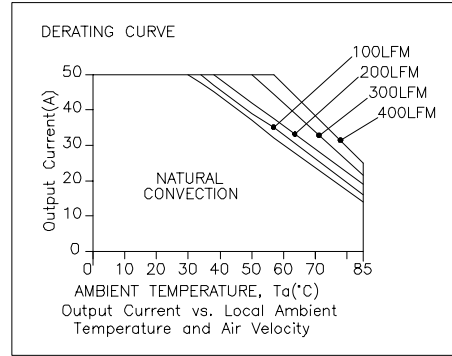

0RQB-C5TV8x

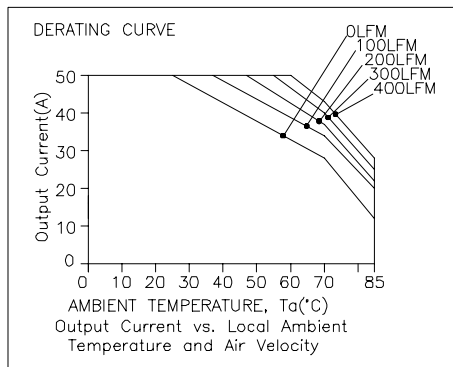

0RQB-C5TV5x

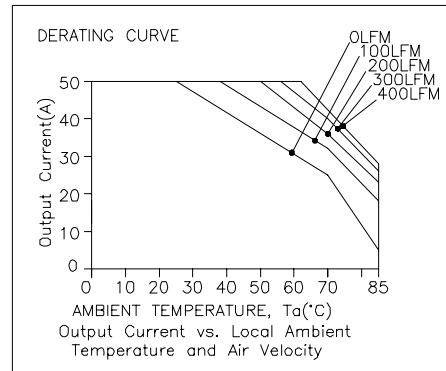

0RQB-C5TV2x

Thermal Reference

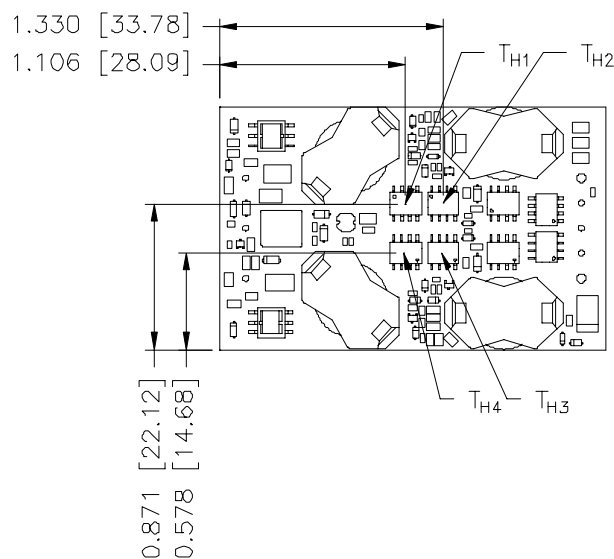

Note: T_{H1}, T_{H2}, T_{H3} and T_{H4} are hot spots which should not exceed 115 degree C.

ISOLATED DC/DC CONVERTERS

48 Vdc Input 12 Vdc/12 A, 3.3 Vdc/46 A, 5 Vdc/30 A, 1.2-2.5 Vdc/50 A Outputs



Ripple and Noise Waveforms

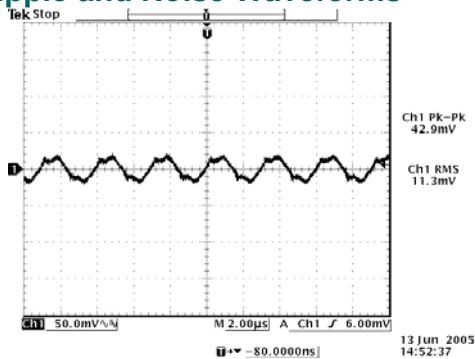

Ripple and noise at full load, 1.2 V/50 A output

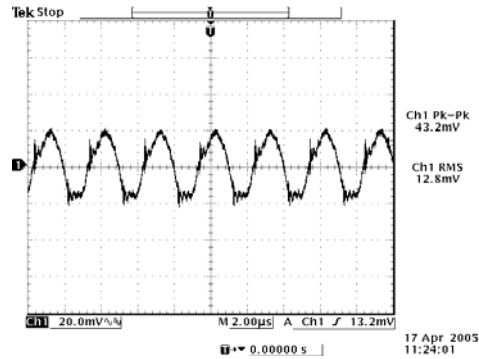

Ripple and noise at full load, 1.5 V/50 A output

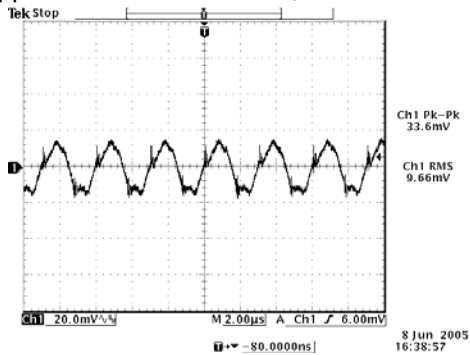

Ripple and noise at full load, 1.8 V/50 A output

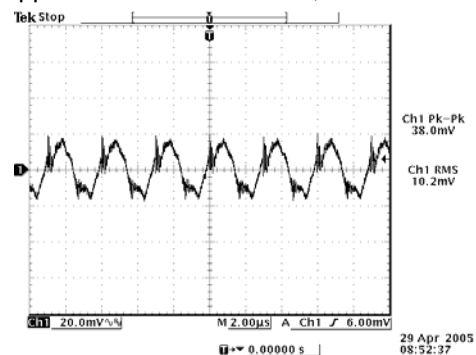

Ripple and noise at full load, 2.5 V/45 A output

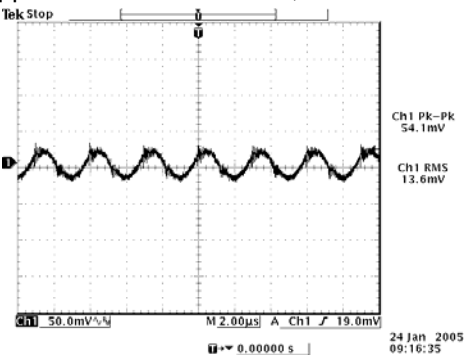

Ripple and noise at full load, 3.3 V/46 A output

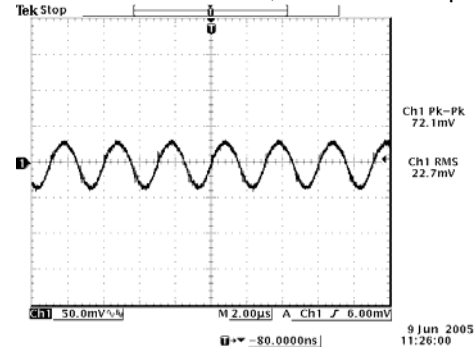

Ripple and noise at full load, 5.0 V/30 A output

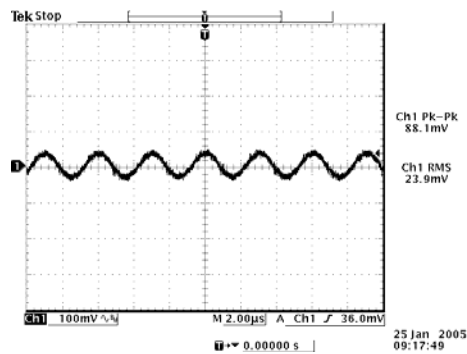

Ripple and noise at full load, 12 V/12 A output

Note: Ripple and noise is tested with a 1 μ F ceramic cap and a 10 μ F tantalum capat output, $T_a=25$ deg C.

ISOLATED DC/DC CONVERTERS

48 Vdc Input 12 Vdc/12 A, 3.3 Vdc/46 A, 5 Vdc/30 A, 1.2-2.5 Vdc/50 A Outputs



Transient Response Waveforms

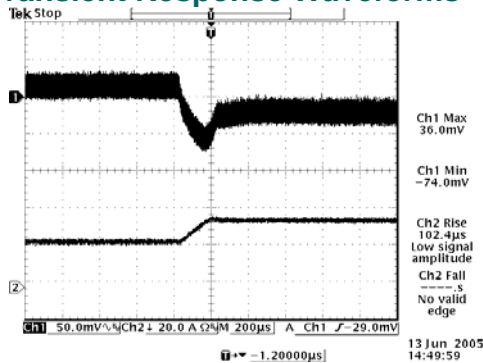

Vout= 1.2 V 50%-75% Load Transients

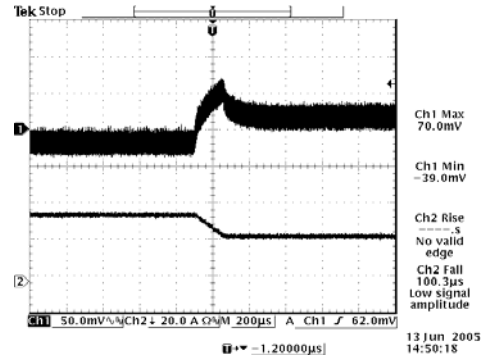

Vout= 1.2 V 75%-50% Load Transients

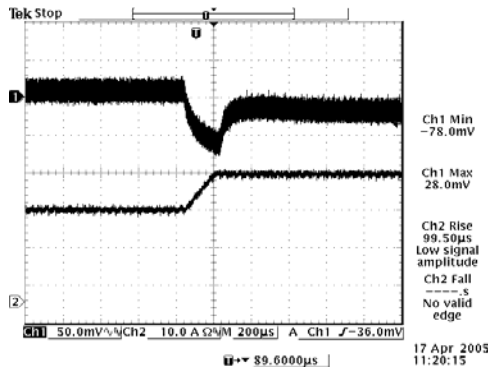

Vout= 1.5 V 50%-75% Load Transients

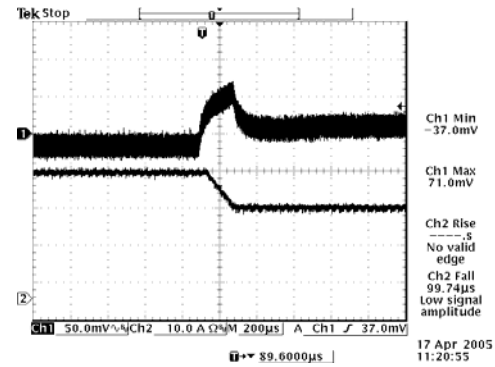

Vout= 1.5 V 75%-50% Load Transients

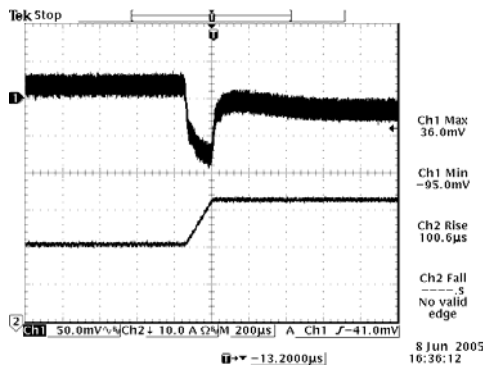

Vout= 1.8 V 50%-75% Load Transients

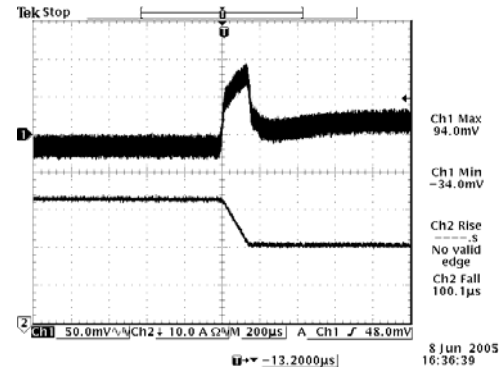

Vout= 1.8 V 75%-50% Load Transients

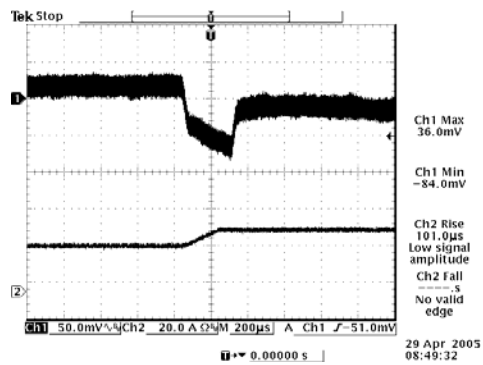

Vout= 2.5 V 50%-75% Load Transients

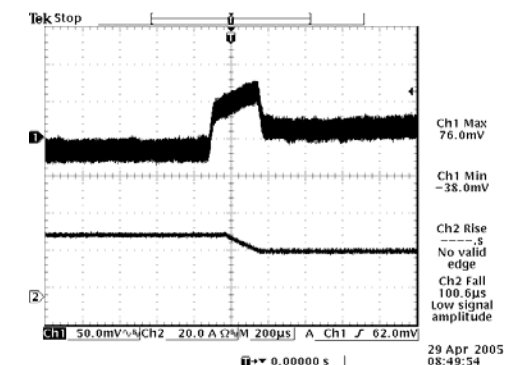

Vout= 2.5 V 75%-50% Load Transients

ISOLATED DC/DC CONVERTERS

48 Vdc Input 12 Vdc/12 A, 3.3 Vdc/46 A, 5 Vdc/30 A, 1.2-2.5 Vdc/50 A Outputs



Transient Response Waveforms (continued)

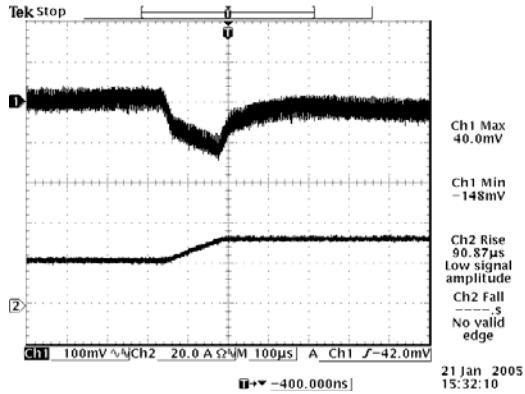

Vout= 3.3 V 50%-75% Load Transients

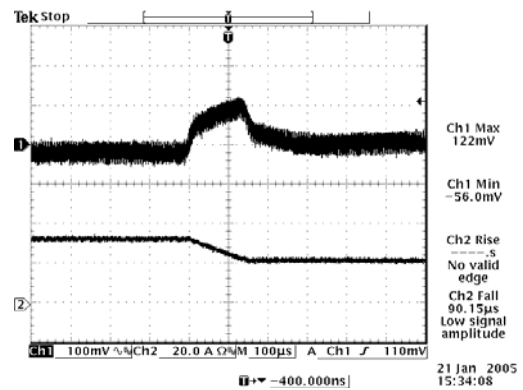

Vout= 3.3 V 75%-50% Load Transients

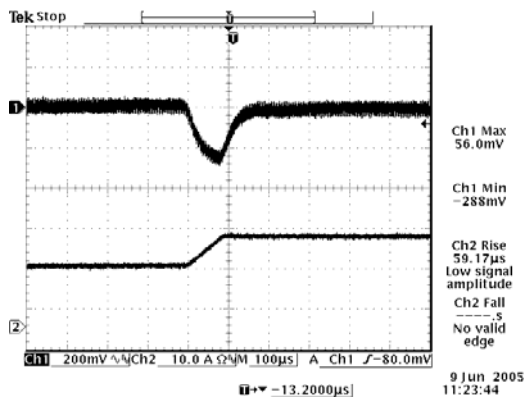

Vout= 5.0 V 50%-75% Load Transients

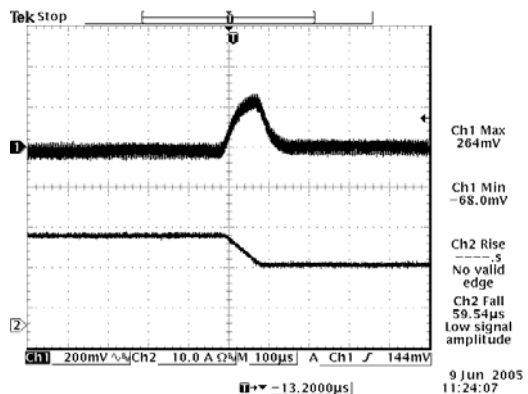

Vout= 5.0 V 75%-50% Load Transients

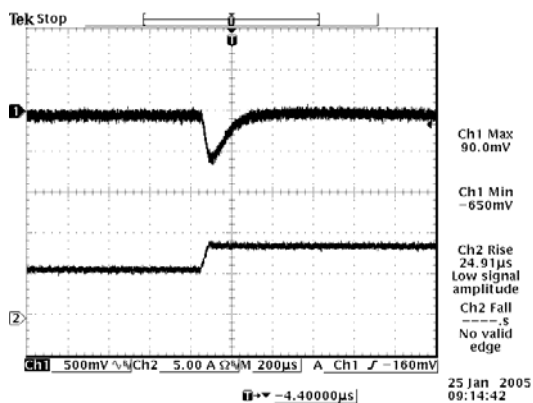

Vout= 12 V 50%-75% Load Transients

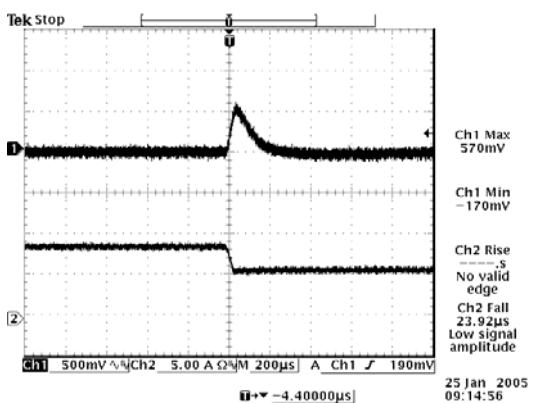

Vout= 12 V 75%-50% Load Transients

Note: Transient response at Vin=48 V, di/dt = 0.1 A/uS, with a 1 uF ceramic capacitor and a 10 uF Tantalum capacitor at the output, Ta=25 deg C.

ISOLATED DC/DC CONVERTERS

48 Vdc Input 12 Vdc/12 A, 3.3 Vdc/46 A, 5 Vdc/30 A, 1.2-2.5 Vdc/50 A outputs



Mechanical Outline

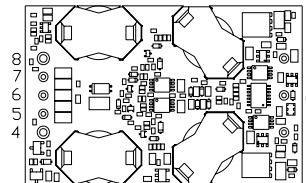
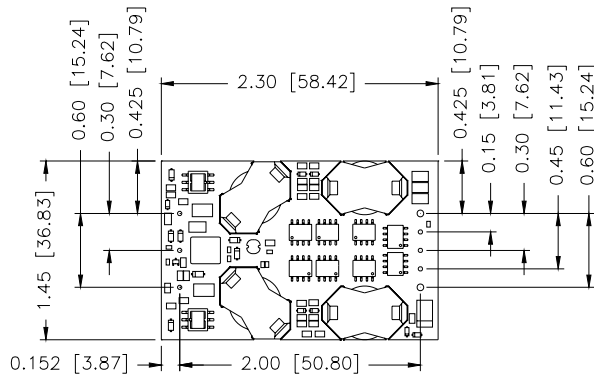

BOTTOM VIEW

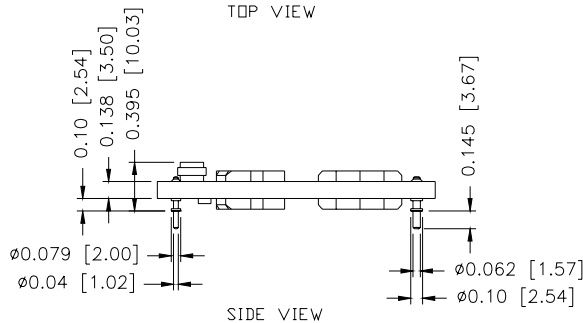

SIDE VIEW

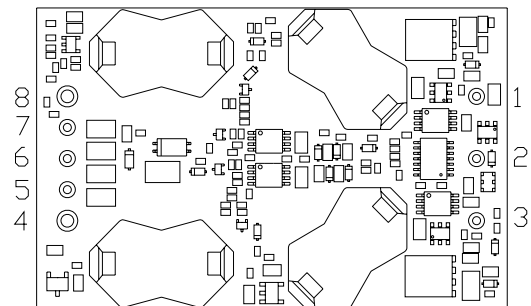

BOTTOM VIEW

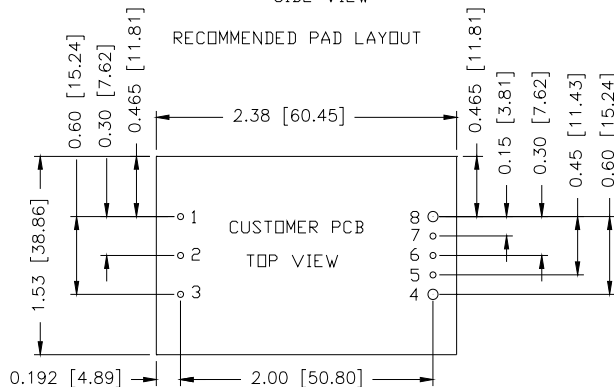

1,2,3,5,6,7 ϕ 0.047 HOLE SIZE, ϕ 0.08 min PAD SIZE
4,8 ϕ 0.07 HOLE SIZE, ϕ 0.10 min PAD SIZE

Pin Connections

Pin	Function	Pin Size
1	Vin (+)	0.04"
2	Remote On/Off	0.04"
3	Vin (-)	0.04"
4	Vout (-)	0.062"
5	Remote Sense (-)	0.04"
6	Trim	0.04"
7	Remote Sense (+)	0.04"
8	Vout (+)	0.062"

RoHS Compliance

Complies with the European Directive 2002/95/EC, calling for the elimination of lead and other hazardous substances from electronic products.



©2007 Bel Fuse Inc. Specifications subject to change without notice. 030307

CORPORATE

Bel Fuse Inc.
206 Van Vorst Street
Jersey City, NJ 07302
Tel 201-432-0463
Fax 201-432-9542
www.belfuse.com

FAR EAST

Bel Fuse Ltd.
8F/ 8 Luk Hop Street
San Po Kong
Kowloon, Hong Kong
Tel 852-2328-5515
Fax 852-2352-3706
www.belfuse.com

EUROPE

Bel Fuse Europe Ltd.
Preston Technology Management Centre
Marsh Lane, Suite G7, Preston
Lancashire, PR1 8UD, U.K.
Tel 44-1772-556601
Fax 44-1772-888366
www.belfuse.com