

ISOLATED DC/DC CONVERTERS

36 Vdc - 75 Vdc Input +12 Vdc/5 A, -12 Vdc/1.5 A Dual Outputs

bel
POWER PRODUCTS

0RXU-75TD10

RoHS Compliant

Rev.A

- Isolated
- Fixed Frequency (300 kHz)
- High Efficiency
- High Power Density
- Input Under- Voltage Lockout (UVLO)
- UL60950-1 Recognized (UL/cUL) and CE Mark
- Low Cost
- SCP/OCP
- Remote On/Off
- Output Voltage Trim
- Output Over-Voltage Protection (OVP)
- Over Temperature Protection



Description

The 0RXU-75TD10 is an isolated dc/dc converter that operates from a nominal 48 Vdc source. It provides up to 78 W of output power with two output voltages. Features include remote on/off, output adjust, short circuit protection, over current protection, over-temperature shutdown, output over voltage protection, and input under voltage lockout. This converter is provided in a compact, through-hole package that is easy to use and provides good thermal performance.

Part Selection

Output Voltage	Input Voltage	Max. Output Current	Max. Output Power	Typical Efficiency	Model Number
+12 Vdc/-12 Vdc	36 Vdc - 75 Vdc	5 A/1.5 A	78 W	90%	0RXU-75TD10

Notes: 1. All part numbers above indicate RoHS 6. Change the second letter "R" to "7" for RoHS 5 part numbers.
2. Add "G" suffix at the end of the model numbers listed above to indicate "Tray Packaging".

Absolute Maximum Ratings

Parameter	Min	Typ	Max	Notes
Input Voltage	-0.3 V	-	100 V	100 V for 10 mS Max.
Remote On/Off	-0.3 V	-	30 V	
Ambient Temperature	-40 °C	-	85 °C	
Storage Temperature	-40 °C	-	125 °C	

Input Specifications

Parameter	Min	Typ	Max	Notes
Input Voltage	36 V	-	75 V	
Input Current (no load)	-	-	200 mA	
Input Current (full load)	-	-	3 A	
Remote Off Input Current	-	10 mA	20 mA	
Input Reflected Ripple Current (rms)	-	10 mA	30 mA	With simulated source impedance of 10 uH, 5 Hz to 20 MHz; use a 100 uF/100 V electrolytic capacitor with ESR=1 ohm max at 200k Hz
Input Reflected Ripple Current (pk-pk)	-	50 mA	100 mA	
Turn On Voltage Threshold	32 V	34 V	35 V	
Turn Off Voltage Threshold	30 V	31 V	33 V	

Note: All specifications are typical at nominal input, full load at 25 °C unless otherwise stated.

ISOLATED DC/DC CONVERTERS

36 Vdc - 75 Vdc Input +12 Vdc/5 A, -12 Vdc/1.5 A Dual Outputs



Output Specifications

Parameter	Min	Typ	Max	Notes
Output Voltage Set Point Vo1=+12 V Vo2=-12 V	+11.76 V -11.86 V	+12 V -12.1 V	+12.24 V -12.34 V	Vin=48 V, Io=50% load
Load Regulation Vo1=+12 V Vo2=-12 V	- -	- -	2% Vo 4% VO	$\Delta I_o1=50\% I_{max1}$; $I_o2=50\% I_{max2}$ $\Delta I_o2=50\% I_{max2}$; $I_o1=50\% I_{max1}$
Line Regulation Vo1=+12 V Vo2=-12 V	- -	- -	1% Vo 1% VO	$I_o1=50\% I_{max1}$; $I_o2=50\% I_{max2}$
Regulation Over Temperature	-	-	0.02% /°C	(-40 °C to +85 °C)
Output Current Vo1=+12 V Vo2=-12 V	0.06 A 0.06 A	- -	5 A 1.5 A	
Output Current Limit Vo1=+12 V Vo2=-12 V	6 A 1.8 A	- -	7.5 A 2.25 A	Hiccup Mode
Short Circuit Protection	-	-	-	Hiccup Mode
Startup Time Power Up Remote On/Off	- -	10 mS 7 mS	20 mS 20 mS	
Overshoot at Turn On	-	-	5%	
Ripple and Noise (rms) Vo1=+12 V Vo2=-12 V	- -	25 mV 10 mV	50 mV 50 mV	Test conditions: 0-20 MHz Bandwidth, with a 1 uF ceramic capacitor at the output.
Ripple and Noise (pk-pk) Vo1=+12 V Vo2=-12 V	- -	75 mV 40 mV	150 mV 150 mV	
Output Capacitance	0 uF	-	1,000 uF	For both Vo1 and Vo2

Transient Response

50% ~ 75% Max Load	Overshoot	Vo1=+12 V	-	300 mV	600 mV	Test conditions: di/dt=0.5 A/us, Vin=48 V
	Settling Time		-	150 uS	300 uS	
75% ~ 50% Max Load	Overshoot		-	300 mV	600 mV	
	Settling Time		-	150 uS	300 uS	
50% ~ 75% Max Load	Overshoot	Vo2=-12 V	-	300 mV	600 mV	
	Settling Time		-	150 uS	300 uS	
75% ~ 50% Max Load	Overshoot		-	300 mV	600 mV	
	Settling Time		-	150 uS	300 uS	

Note: All specifications are typical at nominal input, full load at 25 °C unless otherwise stated.

ISOLATED DC/DC CONVERTERS

36 Vdc - 75 Vdc Input +12 Vdc/5 A, -12 Vdc/1.5 A Dual Outputs



General Specifications

Parameter	Min	Typ	Max	Notes
Efficiency	84%	90%	-	V _{in} = 48 V; Full Load
Switching Frequency	270k Hz	300k Hz	330k Hz	
I/O Isolation Voltage	-	1500 V	-	
Isolation Capacitance	-	1500 pF	-	
Output Trim Range	90%	-	110%	
Output Over Voltage Protection V _{O1} =+12 V V _{O2} =-12 V	+13.5 V -13.5 V	+15 V -15 V	+17 V -17 V	Hiccup Mode Hiccup Mode
Over-temperature	-	130 °C	-	
MTBF	2,366,749 hours			Calculated Per Bell Core SR-332 (I _o = 80% I _{max} ; T _A = 25 °C)
Dimensions Inches (L × W × H) Millimeters (L × W × H)	2.28 x 2.4 x 0.48 57.9 x 61.0 x 12.09			
Weight	-	45 g	-	

Note: All specifications are typical at nominal input, full load at 25 °C unless otherwise stated.

Control Specifications

Parameter	Min	Typ	Max	Notes
Remote On/Off				
Signal Low (Unit On)	-0.3 V	-	1.8 V	Active Low; Remote On/Off pin open, Unit off.
Signal High (Unit Off)	3.5 V	-	12 V	

Output Trim Equations

Equations for calculating the trim resistor (in kΩ) given the desired adjusted voltage (V_{adj}) and the nominal output voltage of the converter (V_{nom}) are shown below. The Trim Down resistor should be connected between the Trim pin and V_{O1}. The Trim Up resistor should be connected between the Trim pin and COM. Only one of the resistors should be used for any given application.

$$R_{trim_down} = \frac{99.86}{V_{nom} - V_{adj}} - 20.5$$

$$R_{trim_up} = \frac{26.25}{V_{adj} - V_{nom}} - 10$$

Note: Output voltage V_o=12.012 V

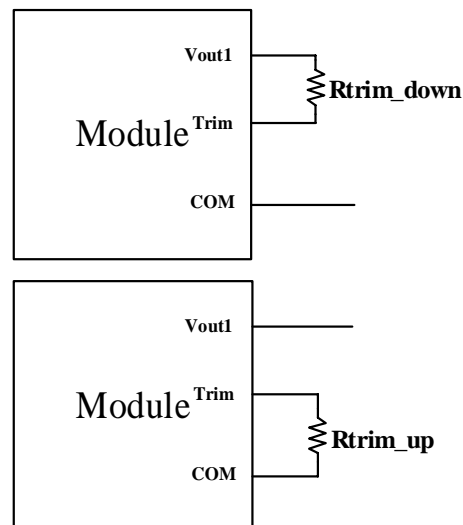

ISOLATED DC/DC CONVERTERS

36 Vdc - 75 Vdc Input +12 Vdc/5 A, -12 Vdc/1.5 A Dual Outputs



Efficiency Data

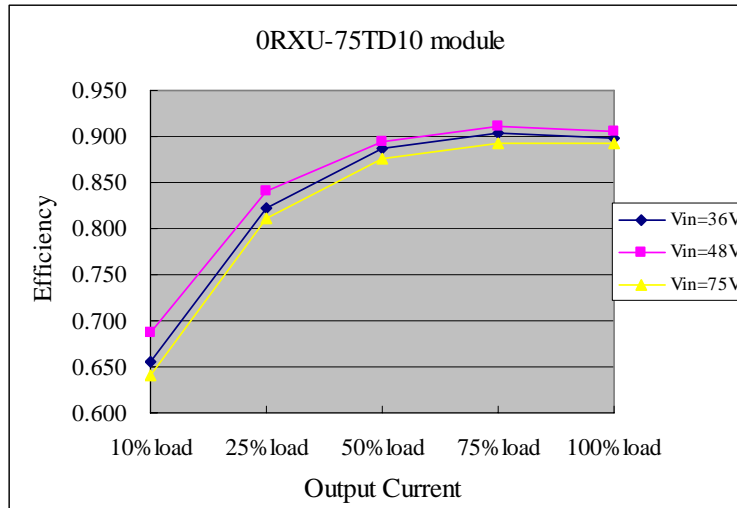

Thermal Derating Curve (Vin=48 V)

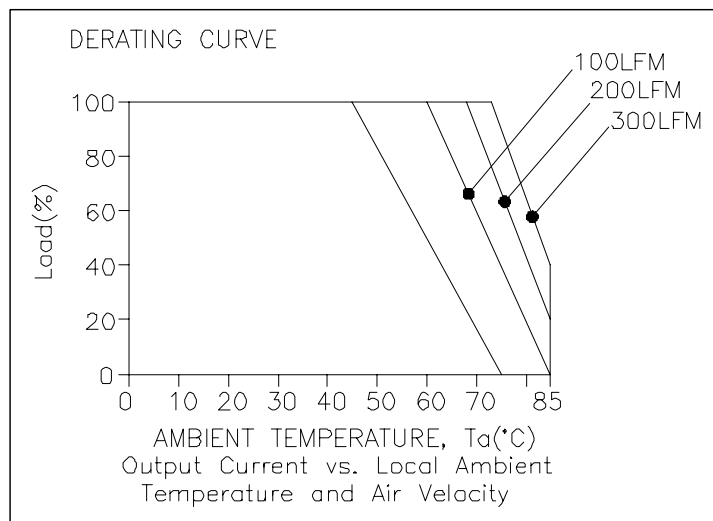

ISOLATED DC/DC CONVERTERS

36 Vdc - 75 Vdc Input +12 Vdc/5 A, -12 Vdc/1.5 A Dual Outputs



Ripple and Noise Waveforms

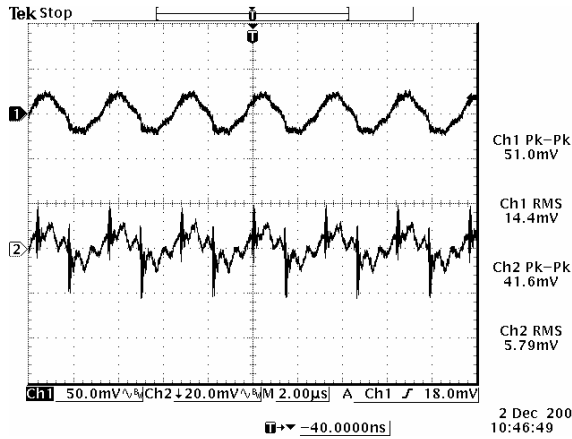

Ripple and noise at full load, 36 V input, ch1 (+)12 V/5 A output, (-)12 V/1.5 A

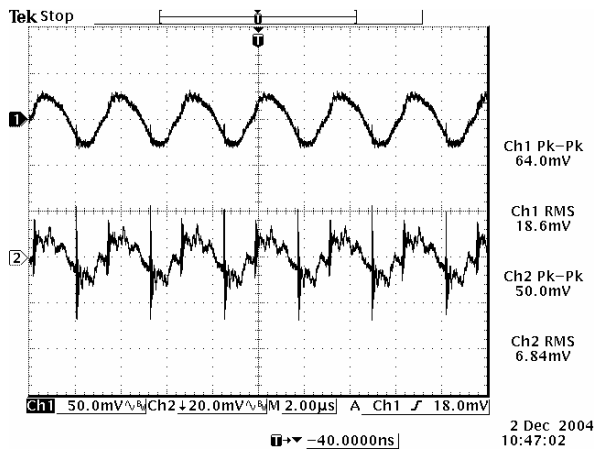

Ripple and noise at full load, 48 V input, ch1 (+)12 V/5 A output, (-)12 V/1.5 A

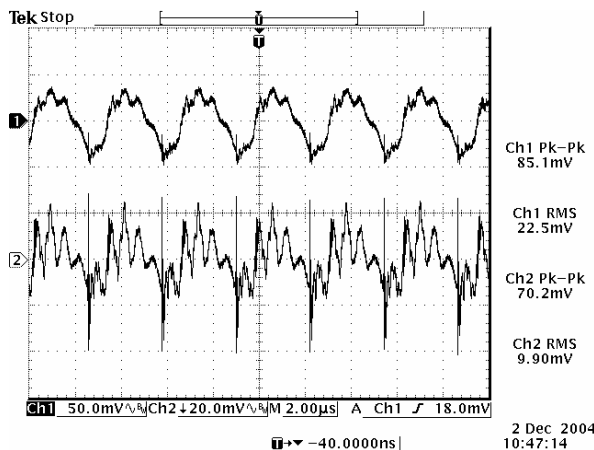

Ripple and noise at full load, 75 V input, ch1 (+)12 V/5 A output, (-)12 V/1.5 A

Note: With a 1µF ceramic capacitor at the output, $T_a=25$ deg C.

ISOLATED DC/DC CONVERTERS

36 Vdc - 75 Vdc Input +12 Vdc/5 A, -12 Vdc/1.5 A Dual Outputs



Transient Response Waveforms

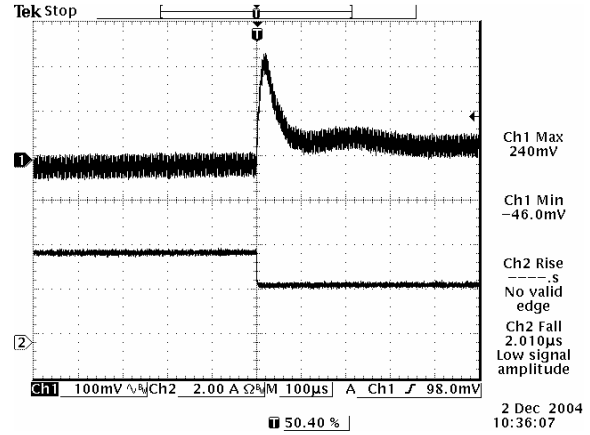
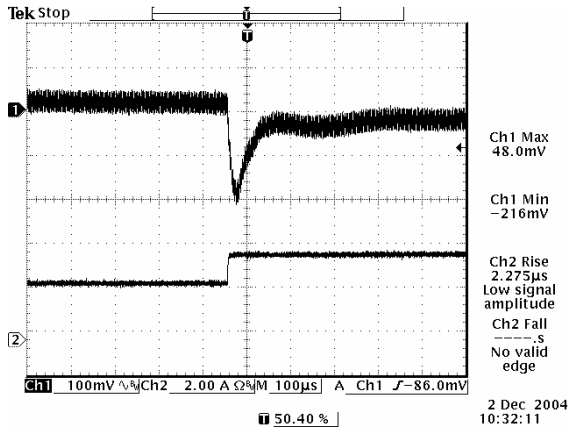

Vout=(+12 V 50%-75% Load Transients at Vin=36 V

Vout=(+12 V 75%-50% Load Transients at Vin=36 V

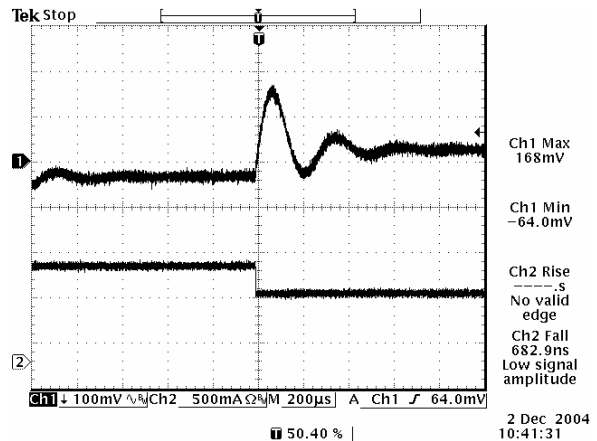
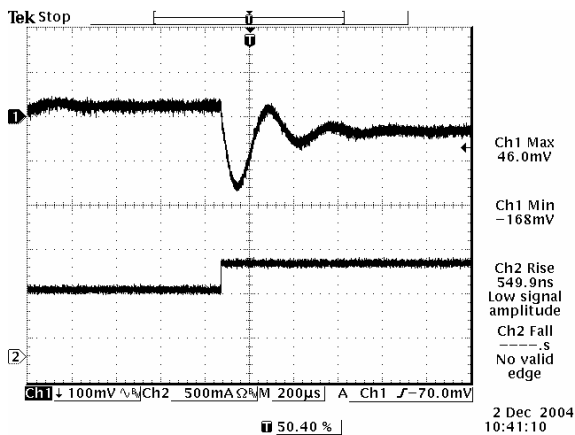

Vout=(-12 V 50% - 75% Load Transients at Vin=36 V

Vout=(-12 V 75% -50% Load Transients at Vin=36 V

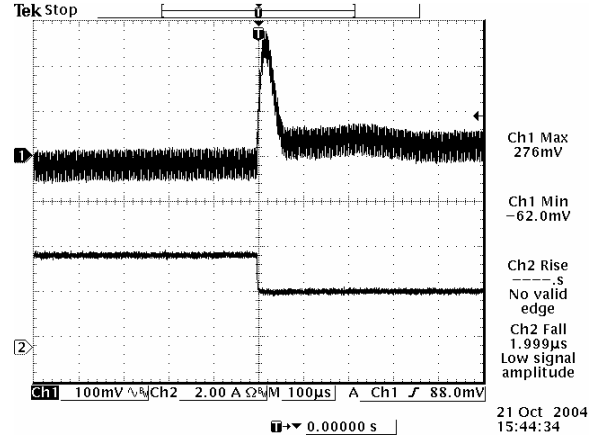
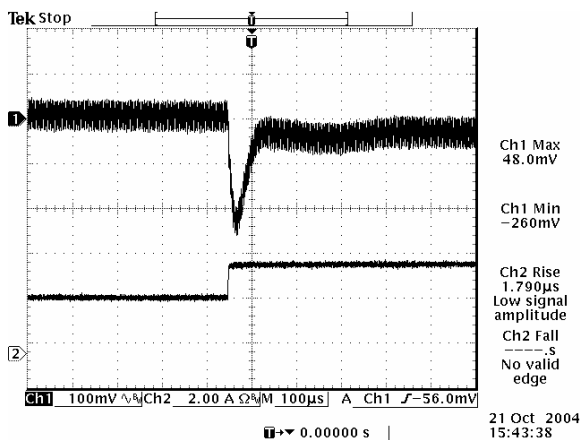

Vout=(+12 V 50%-75% Load Transients at Vin=48 V

Vout=(+12 V 75%-50% Load Transients at Vin=48 V

ISOLATED DC/DC CONVERTERS

36 Vdc - 75 Vdc Input +12 Vdc/5 A, -12 Vdc/1.5 A Dual Outputs



Transient Response Waveforms (continued)

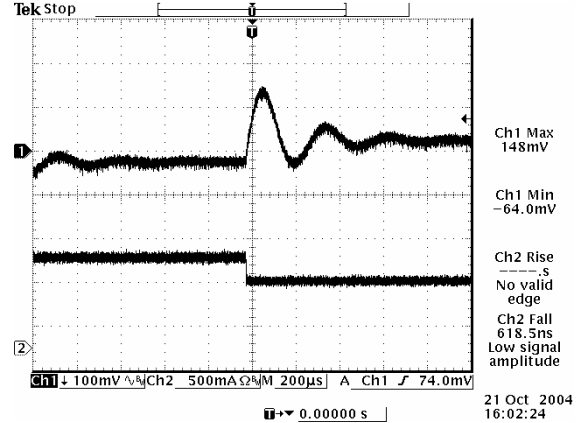
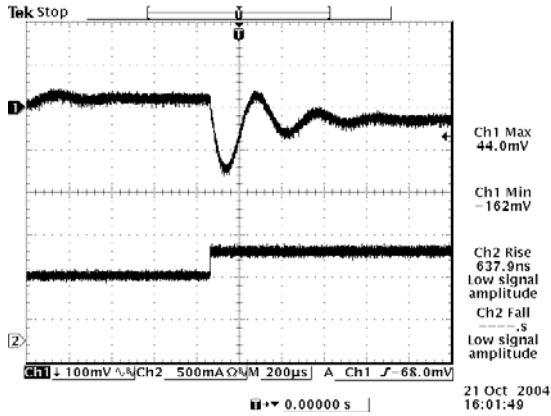

Vout=(-)12 V 50% - 75% Load Transients at Vin=48 V

Vout=(-)12 V 75% -50% Load Transients at Vin=48 V

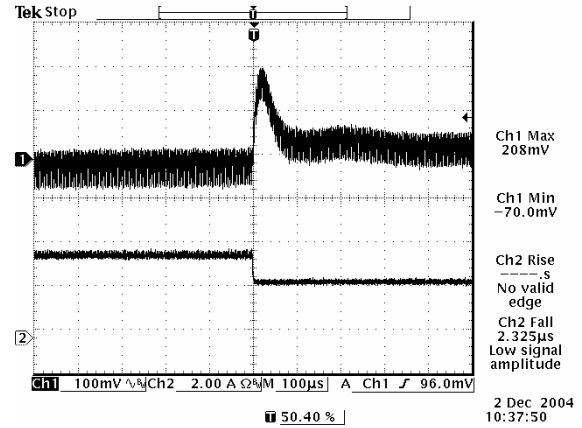
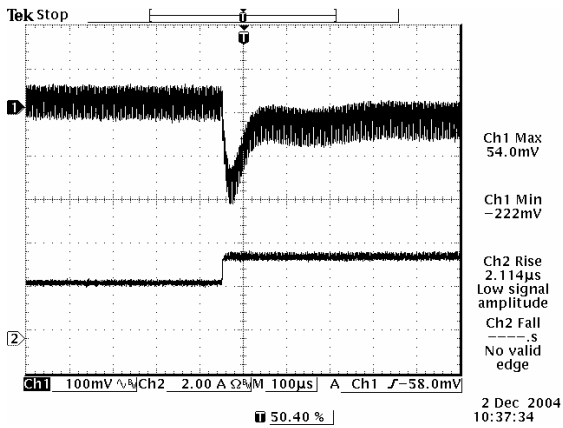

Vout=(+)12 V 50%-75% Load Transients at Vin=75 V

Vout=(+)12 V 75%-50% Load Transients at Vin=75 V

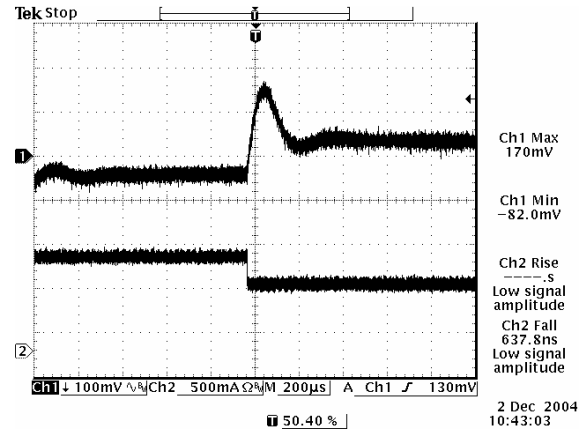
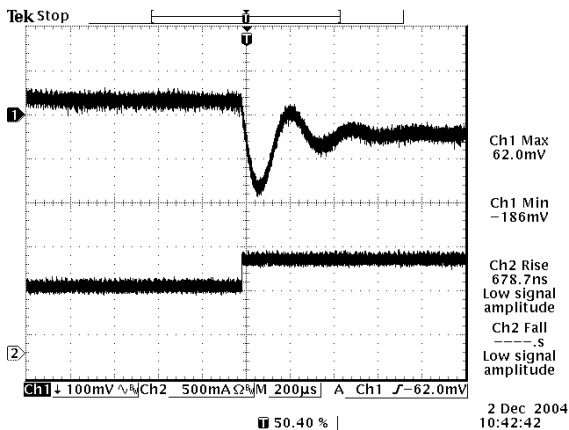

Vout=(-)12 V 50% - 75% Load Transients at Vin=75 V

Vout=(-)12 V 75% -50% Load Transients at Vin=75 V

ISOLATED DC/DC CONVERTERS

36 Vdc - 75 Vdc Input +12 Vdc/5 A, -12 Vdc/1.5 A Dual Outputs



Mechanical Outline

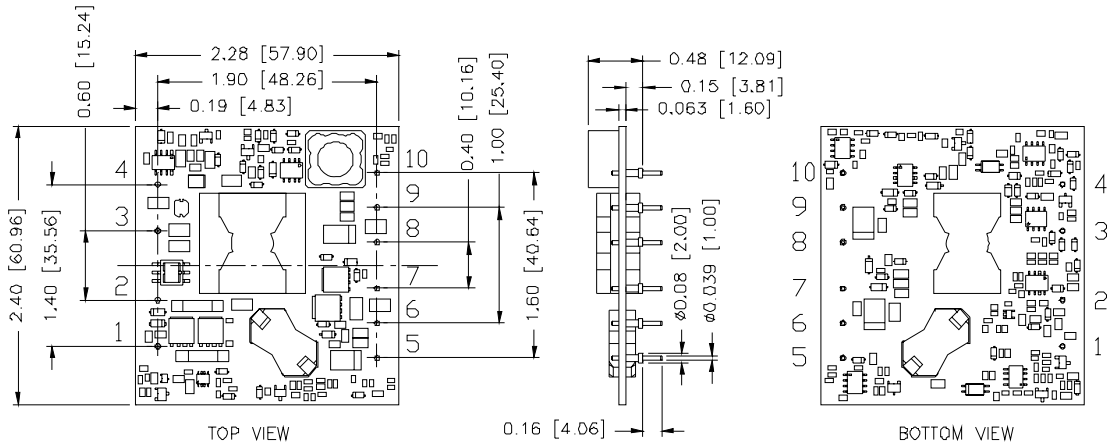

RECOMMENDED PAD LAYOUT

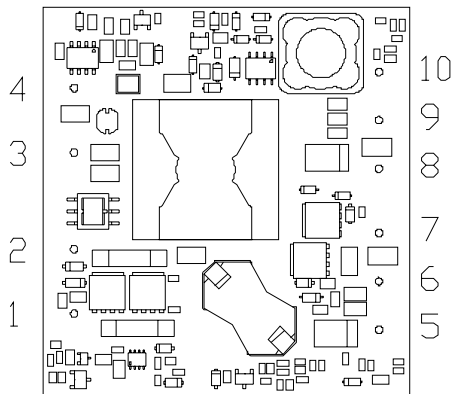
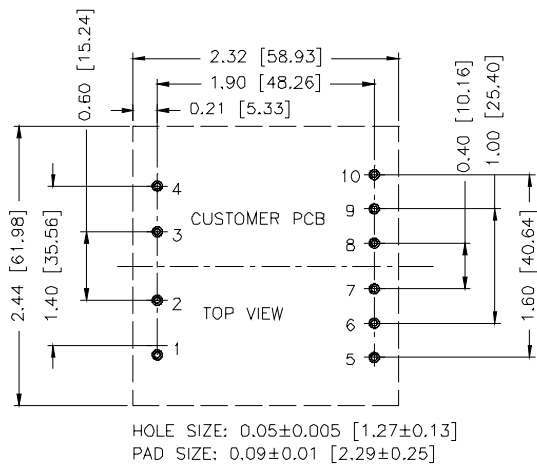

Pin Connections

Pin	Function	Pin	Function
1	-Vin	6	COM
2	FG	7	Trim
3	REM	8	COM
4	+Vin	9	-Vo1 (-12 V)
5	+Vo1 (+12 V)	10	No Connection

RoHS Compliance

Complies with the European Directive 2002/95/EC, calling for the elimination of lead and other hazardous substances from electronic products.



©2007 Bel Fuse Inc. Specifications subject to change without notice. 030107

CORPORATE

Bel Fuse Inc.
206 Van Vorst Street
Jersey City, NJ 07302
Tel 201-432-0463
Fax 201-432-9542
www.belfuse.com

FAR EAST

Bel Fuse Ltd.
8F/ 8 Luk Hop Street
San Po Kong
Kowloon, Hong Kong
Tel 852-2328-5515
Fax 852-2352-3706
www.belfuse.com

EUROPE

Bel Fuse Europe Ltd.
Preston Technology Management Centre
Marsh Lane, Suite G7, Preston
Lancashire, PR1 8UD, U.K.
Tel 44-1772-556601
Fax 44-1772-888366
www.belfuse.com