

DORADO MV DC/DC CONVERTERS

48V Input – 12VDC – 8A Output



GMDW12V08

GMDW12V08 – 1/4 Brick Dorado MV Series

- Industry standard pinout and footprint
- High efficiency: 86% at 12V, 8A; 88% at 12V, 4A
- Low profile
- Very low common-mode noise for a commercial DC/DC converter
- Constant switching frequency
- Remote sense
- Single board design
- Optional low profile heat sink for improved thermal performance
- Header with M3 metal inserts for mechanical connection to PCB



Control Functions

- Microprocessor controlled
- Primary-side enable, choice of logic
- Industry standard output trim

Typical Characteristics

- Output setpoint accuracy: $\pm 1\%$
- Load regulation: $\pm 0.2\%$
- Line regulation: $\pm 0.2\%$
- Regulation over line, load and temperature: $\pm 2\%$
- Low output ripple

Protection Features

- Over temperature protection
- Over voltage protection
- Over current protection
- Over/Under input voltage protection



Certified to ISO 9001:2000

Ordering Information

Standard Model Number	Input Voltage	Output Voltage	Max Current
GMDW12V08*	48V	12V	8A

* Options:

P = Positive Logic Version; High = On
M = 0.145" Pins ($\pm .01"$)
S = 0.12" Pins ($\pm .01"$)
R = Heat Sink-Ready
L = Low Profile (0.465" height)

Dorado MV Heat Sink Part Numbers

Part Number	Height	Typical Thermal Performance	
		Natural Convection Power Dissipation†	Forced Convection Thermal Resistance‡
001	0.25"	5W	5.8° C/W
002	0.50"	7W	3.2° C/W
003	1.00"	11W	2.0° C/W
004	0.13"	TBD	TBD

† @ 60° C rise heat sink to ambient

‡ @ 300'/min.

Example Part Number:
(All options)

GMDW12V08 PSR 00X L

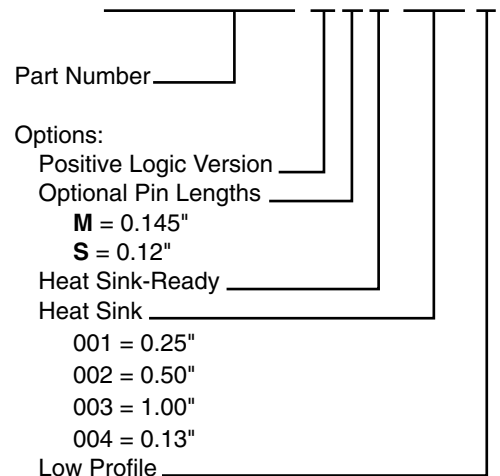

GMDW12V08

Input Specifications

Parameter	Min	Typical	Max	Units
Operating Input Voltage	36	48	75	V _{DC}
Input Current			4	A
Input Capacitance		2		μF
Input Hysteresis, Low Line		2		V _{DC}

V_{IN} = 48V_{DC}, T_A @ 25° C, 300 LFM Airflow, V_{OUT} = 12V_{DC}, I_{OUT} = Full load unless otherwise noted.
 Available output power depends on ambient temperature and good thermal management.
 (See application graphs for limits.)

Output Specifications

Parameter	Min	Typical	Max	Units
Regulation Over Line, Load & Temperature	98		102	%V _{NOM}
Voltage Ripple			20	mV _{RMS}
Voltage Ripple, 20MHz BW			100	mV _{P-P}
Current Range	0		8	A
Current Limit Inception	110	125		%I _{OUT}
Output Transient Response, 50% to 75% Load Change, 1A/μsec			5	%V _{OUT}
Settling Time to ± 1%			400	μS
Turn-on Time to 98% Vnom			300	mS
Output Overshoot at Turn-on			1	%V _{OUT}
Trim Range	60		110	%V _{OUT}
Over Voltage Protection, Non-Latching		125		%V _{OUT}

DORADO MV DC/DC CONVERTERS

48V Input – 12VDC – 8A Output



GMDW12V08

Isolation Specifications

Parameter	Min	Typical	Max	Units
Isolation Test Voltage, Input/Baseplate/Output (Basic)	2000			V _{DC}
Isolation Resistance	10			MΩ

Features

Parameter	Min	Typical	Max	Units
Over Temperature Protection, Thermal Sensor, Non-latching ¹			117	°C
Switching Frequency, Fixed		300		kHz

1. PCB less than 130° C.

General Specifications

Operating Temperature	-40° C to + 100° C
Storage Temperature	-55° C + 125° C
Relative Humidity	10% to 95% RH, Non-condensing
Vibration	2 to 9 Hz, 3mm disp., 9 to 200 Hz, 1g
Material Flammability	UL V-0
Weight	30 grams
MTBF Telcordia (Bellcore)	2.0 million hours

Approvals and Standards

UL and c-UL Recognized Component, TUV, UL60950, CSA 22.2 No. 950, IEC/EN 60950**

EMC Characteristics:

Designed to meet emission and immunity requirements per EN55022, CISPR 22, Class B, and CISPR 24.

** An external fuse shall be used to comply with the requirements.

Application Notes

CoolConverter™

Bel Power's Proprietary CoolConverter™

- Patented single-stage power conversion architecture, control and magnetic design allow unprecedented power density and efficiency in an isolated power supply.
- An advanced microcontroller reduces parts count while adding features, performance and flexibility in the design.

Protection and Control

Valid Input Voltage Range

The converter measures the input voltage and will not allow operation outside of the input voltage specification. As shown by the graphs, hysteresis is added to both the high and low voltage to prevent the converter from turning on and off repeatedly when the voltage is held near either voltage extreme. At low line, this assures the maximum input current is not exceeded; at high line, this assures the semiconductor devices in the converter are not damaged by excessive voltage stress.

ON/OFF Logic Option

The ON/OFF control logic can be either Negative (standard) or Positive to enable the converter. For Negative logic, the ON/OFF pin is brought to below 1.0V with respect to the -INPUT pin to enable the converter. The pull-down must be able to sink 100µA. For Positive logic, the ON/OFF pin is brought to greater than 4.0V with respect to the -INPUT pin and be limited to less than 10V. To request the Positive logic version, add the suffix (P) to the standard part number. The ON/OFF pin has a built-in pull-up resistor of approximately 100kΩ to +5V.

Output Over Voltage Protection

The output voltage is constantly monitored by the microprocessor with a redundant secondary-side measurement circuit that both shuts down the duty cycle and triggers the microprocessor to shut down. If the output voltage exceeds the over voltage specification, the microprocessor will latch the converter off. To turn the converter on required either cycling the ON/OFF pin or power to the converter. This advanced feature prevents the converter from damaging the load if there is a converter failure or application error. If non-latching is required, consult factory.

Over Voltage Hysteresis

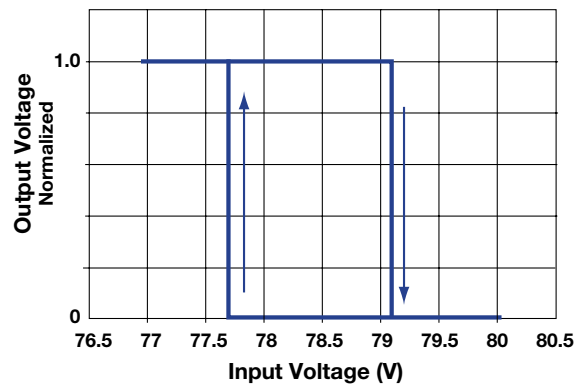

Under Voltage Hysteresis

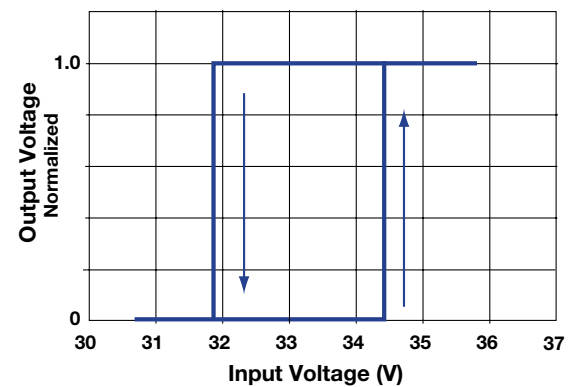

DORADO MV DC/DC CONVERTERS

48V Input – 12VDC – 8A Output



GMDW12V08

CoolConverter™

Protection and Control

Thermal Shutdown

The printed circuit board temperature is measured using a semiconductor sensor. If the maximum rated temperature is exceeded, the converter is latched off. It will then restart every 4 seconds.

Remote Sense

The output voltage is regulated at the point where the sense pins connect to the power output pins. Total sense compensation should not exceed 1V.

Safety

An external input fuse must always be used to meet these safety requirements.

External Output Trimming

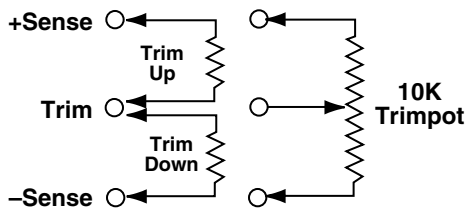

Trim

To trim the output voltage higher, connect the required trim resistor from the Trim pin to the +Sense pin. To trim the output voltage lower, connect the required trim resistor from the Trim pin to the -Sense pin. See the diagrams at right.

Trim-up

$$R_{\text{TRIM-UP}} = \left\{ \frac{12 (100+\Delta\%)}{1.225\Delta\%} - \frac{(100+2\Delta\%)}{\Delta\%} \right\} 5.11\text{k}\Omega$$

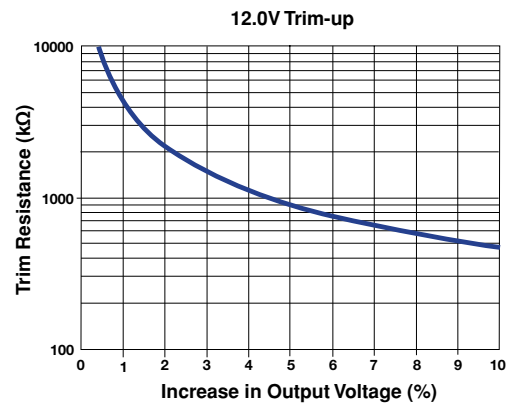

Trim-down

$$R_{\text{TRIM-DOWN}} = \left\{ \frac{100}{\Delta\%} - 2 \right\} 5.11\text{k}\Omega$$

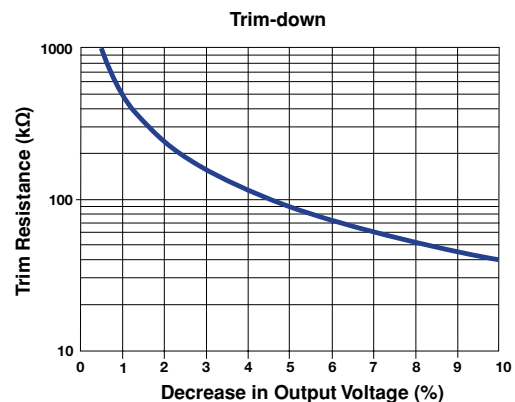

GMDW12V08

Efficiency Data

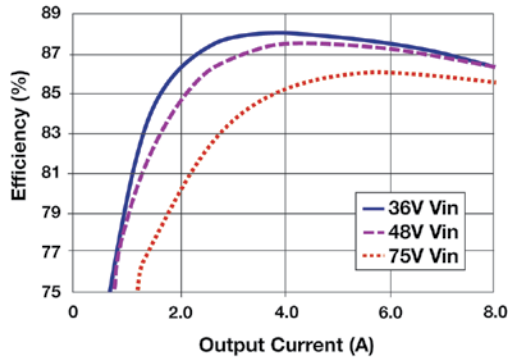

Power Dissipation

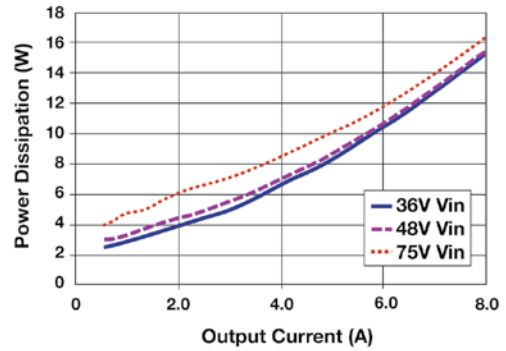

Start Up

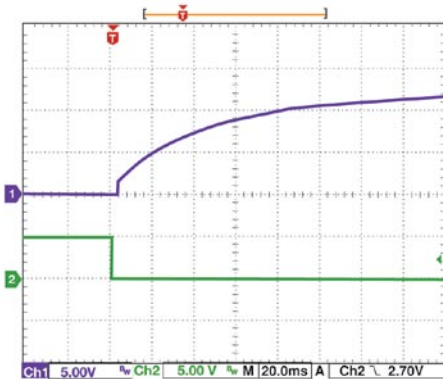

1. V_{OUT} 5V/div 20mS/div
2. Enable 5V/div

Voltage Ripple

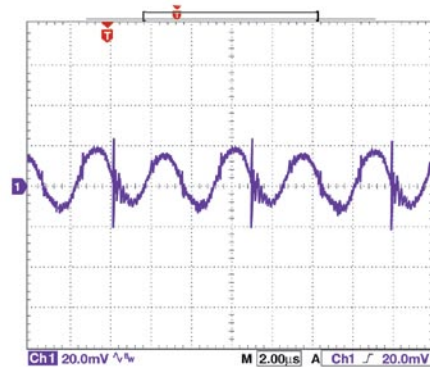

1. V_{OUT} 20mV/div 2μS/div

Line/Load Regulation

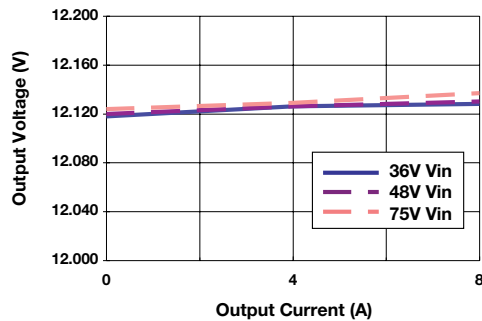

Transient Response

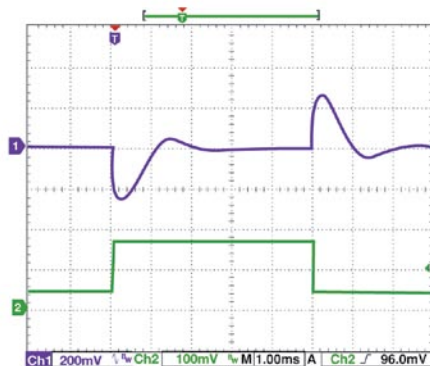

1. V_{OUT} 200mV/div 1ms/div
2. Enable 100mV/div

DORADO MV DC/DC CONVERTERS

48V Input – 12VDC – 8A Output



GMDW12V08

Mechanical

GMDW12V08

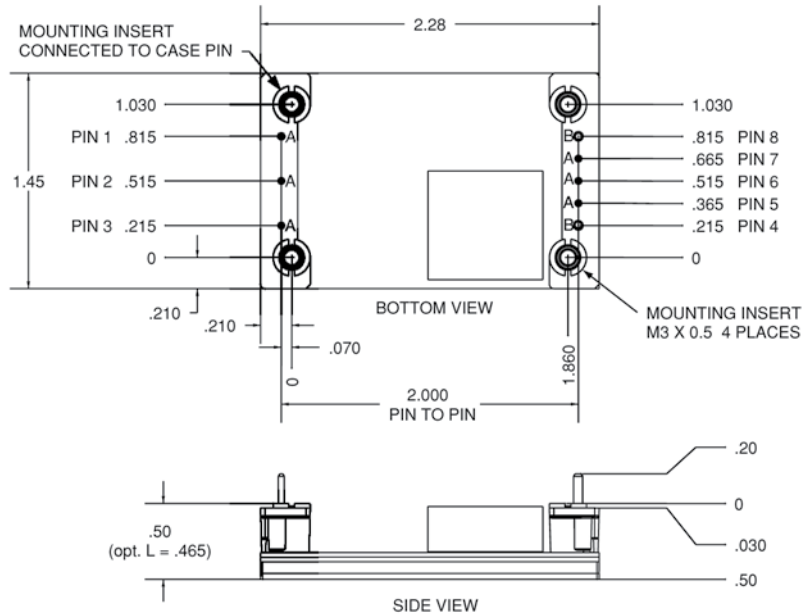

Pin Configuration – Bottom View

Pin	Function	Pin Dia. (In.)
1	- Input	0.040
2	On/Off	0.040
3	+ Input	0.040
4	+ Output	0.060
5	+ Sense	0.040
6	Trim	0.040
7	- Sense	0.040
8	- Output	0.060

Notes:

- Mechanical tolerances
 x.xxx in. = ± 0.005 in.
 x.xx in = ± 0.01 in.
- Pin material: Brass with tin/lead plating over nickel
- Workmanship: Meets or exceeds IPC-A-610B Class II
- "A" = 0.040" dia. pins
- "B" = 0.060" dia. pins
- Min. screw length for heat sink attachment
 = 4.5mm + heat sink flange + locking hardware

RoHS Compliance

Complies with the European Directive 2002/95/EC, calling for the elimination of lead and other hazardous substances from electronic products. These parts are not however compatible with the higher temperatures associated with lead free solder processes and must be soldered using a reflow profile with a peak temperature of no more than 240°C.



©2006 Bel Fuse Inc. Specifications subject to change without notice. 11.06

CORPORATE

Bel Fuse Inc.
 206 Van Vorst Street
 Jersey City, NJ 07302
 Tel 201-432-0463
 Fax 201-432-9542
 www.belfuse.com

FAR EAST

Bel Fuse Ltd.
 8F / 8 Luk Hop Street
 San Po Kong
 Kowloon, Hong Kong
 Tel 852-2328-5515
 Fax 852-2352-3706
 www.belfuse.com

EUROPE

Bel Fuse Europe Ltd.
 Preston Technology Management Centre
 Marsh Lane, Suite G7, Preston
 Lancashire, PR1 8UD, U.K.
 Tel 44-1772-556601
 Fax 44-1772-888366
 www.belfuse.com