

BOLERO HV DC/DC CONVERTERS

48V Input – 52VDC – 4A Output



GPBW52V04

GPBW52V04 – 1/2 Brick Bolero HV Series

- Industry standard pinout and footprint
- Highest efficiency in the industry: 92% at 52V, 4A; 91% at 52V, 2A
- No heat sink required (baseplate standard)
- Very low common-mode noise for a commercial DC/DC converter
- Two-stage input filter
- Constant switching frequency, 330 kHz
- Remote sense
- Single board SMT construction
- Low profile, 0.43"
- Optional low profile heat sink or baseplate for improved thermal performance
- Header with M3 metal inserts for mechanical connection to PCB

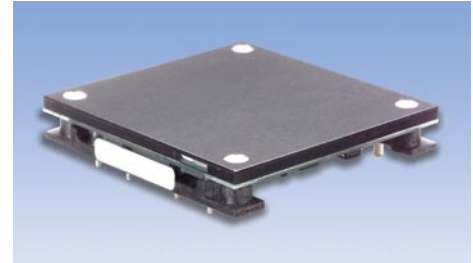

Typical Characteristics

- Output setpoint accuracy: $\pm 2\%$
- Load regulation: $\pm 0.25\%$
- Line regulation: $\pm 0.25\%$
- Regulation over line, load and temperature: $\pm 2\%$
- Low output ripple
- 50% output trim-down
- Supports IEEE 802.3af power over LAN
- 2250V isolation

Control Functions

- Microprocessor controlled
- Primary-side enable, choice of logic

Protection Features

- Over temperature protection
- Over voltage protection
- Over current protection
- Over/Under input voltage protection



Certified to ISO 9001:2000

Ordering Information

Standard Model Number	Input Voltage	Output Voltage	Max Current
GPBW52V04*	48V	52V	4A

- * **Options:**
M = 0.145" Pins ($\pm .01$ ") **R** = Heat Sink-Ready
G = Case Ground Pin

Example Part Number:
(All options)

GPBW52V04 MRG 00X

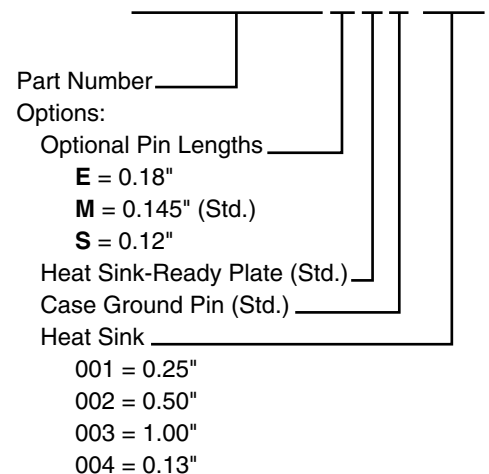

Bolero HV Heat Sink Part Numbers

Part Number	Height	Typical Thermal Performance	
		Natural Convection Power Dissipation†	Forced Convection Thermal Resistance‡
001	0.25"	5W	5.8° C/W
002	0.50"	7W	3.2° C/W
003	1.00"	11W	2.0° C/W
004	0.13"	TBD	TBD

† @ 60° C rise heat sink to ambient

‡ @ 300'/min.

GPBW52V04

Input Specifications

Parameter	Min	Typical	Max	Units
Operating Input Voltage	36	48	75	V _{DC}
Input Current			7	A
Input Capacitance		5		μF
Input Hysteresis, Low Line		2		V _{DC}

V_{IN} = 48V_{DC}, T_A @25° C, 300 LFM Airflow, V_{OUT} = 52V_{DC}, I_{OUT} = Full load unless otherwise noted.
 C_{OUT} = 180μF Al-Elec. Available output power depends on ambient temperature and good thermal management. (See application graphs for limits.)

Output Specifications

Parameter	Min	Typical	Max	Units
Setpoint	51.45	52.50	53.55	V _{DC}
Voltage Ripple, 180μF Load Capacitance			30	mV _{RMS}
Voltage Ripple, 180μF Load Capacitance			80	mV _{P-P}
Current Range	0		4	A
Current Limit Inception	100	120		%I _{OUT}
Short Circuit Current ¹			6	A
Settling Time to ± 1% ²			1	mS
Turn-on Time to 98% V _{nom}			40	mS
Output Overshoot at Turn-on			None	%V _{OUT}
Trim Range, Lucent 1/2 Brick Trim	50		105	%V _{OUT}
Over Voltage Protection, Latching		115		%V _{OUT}

1. During short circuit, converter will shut down and attempt to restart once per second. The average current during this condition will be very low and the device can be safely left in this condition continuously.
2. 50% load change only resulted in 1% output voltage step.

BOLERO HV DC/DC CONVERTERS

48V Input – 52VDC – 4A Output



GPBW52V04

Isolation Specifications

Parameter	Min	Typical	Max	Units
Isolation Test Voltage, Input/Output (Basic)	2250			V _{DC}
Isolation Resistance	10			MΩ

Features

Parameter	Min	Typical	Max	Units
Over Temperature Protection, Thermal Sensor, Latching ³			115	°C
Input, Output Ripple Frequency, Fixed		330		kHz

3. PCB less than 130° C.

General Specifications

Operating Temperature, Baseplate	-40° C to + 100° C
Storage Temperature	-55° C + 125° C
Relative Humidity	10% to 95% RH, Non-condensing
Vibration	2 to 9 Hz, 3mm disp., 9 to 200 Hz, 1g
Material Flammability	UL V-0
Weight	55 grams
MTBF Bellcore TR-332	1.6 million hours

Approvals and Standards

UL and c-UL Recognized Component, TUV, UL1950, CSA 22.2 No. 950, IEC/EN 60950** Pending.

EMC Characteristics:

Designed to meet emission and immunity requirements per EN55022, CISPR 22, Class B, and CISPR 24.

** An external fuse shall be used to comply with the requirements.

Application Notes

CoolConverter™

Bel Power’s Proprietary CoolConverter™

- Patented single-stage power conversion architecture, control and magnetic design allow unprecedented power density and efficiency in an isolated power supply.
- An advanced microcontroller reduces parts count while adding features, performance and flexibility in the design.

Protection and Control

Valid Input Voltage Range

The converter measures the input voltage and will not allow operation outside of the input voltage specification. As shown by the graphs, hysteresis is added to both the high and low voltage to prevent the converter from turning on and off repeatedly when the voltage is held near either voltage extreme. At low line, this assures the maximum input current is not exceeded; at high line, this assures the semiconductor devices in the converter are not damaged by excessive voltage stress.

ON/OFF Logic Option

The ON/OFF control logic can be either Negative (standard) or Positive to enable the converter. For Negative logic, the ON/OFF pin is brought to below 1.0V with respect to the –INPUT pin to enable the converter. The pull-down must be able to sink 100µA. For Positive logic, the ON/OFF pin is brought to greater than 4.0V with respect to the –INPUT pin and be limited to less than 10V. To request the Positive logic version, add the suffix (P) to the standard part number. The ON/OFF pin has a built-in pull-up resistor of approximately 100kΩ to +5V.

Output Over Voltage Protection

The output voltage is constantly monitored by the microprocessor with a redundant secondary-side measurement circuit that both shuts down the duty cycle and triggers the microprocessor to shut down. If the output voltage exceeds the over voltage specification, the microprocessor will latch the converter off. To turn the converter on required either cycling the ON/OFF pin or power to the converter. This advanced feature prevents the converter from damaging the load if there is a converter failure or application error. If non-latching is required, consult factory.

Over Voltage Hysteresis

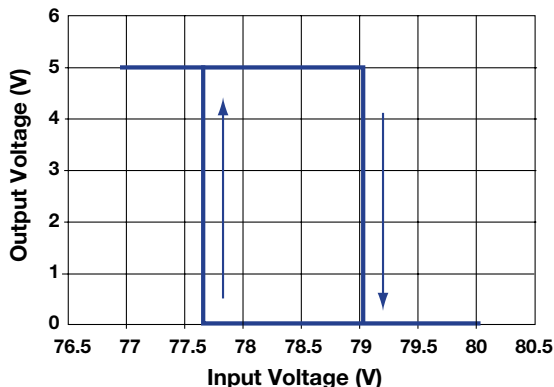

Under Voltage Hysteresis

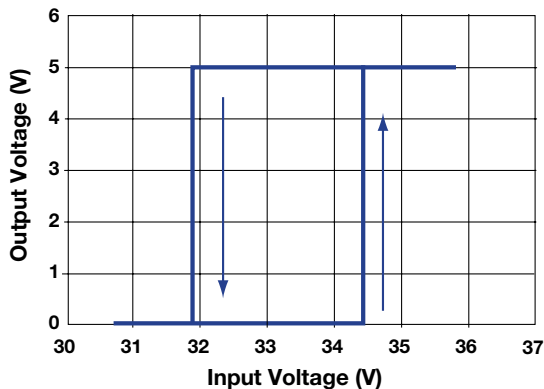

BOLERO HV DC/DC CONVERTERS

48V Input – 52VDC – 4A Output



GPBW52V04

CoolConverter™

Protection and Control

Thermal Shutdown

The printed circuit board temperature is measured using a semiconductor sensor. If the maximum rated temperature is exceeded, the converter is latched off. To re-enable the converter requires cycling the ON/OFF pin or power to the converter. If non-latching shutdown is required, consult factory.

Control Options

As the behavior of the circuit is determined by firmware in the microcontroller, specific requirements, such as:

- non-latching thermal protection
- custom valid input voltage range
- controlled delay from initiating an ON/OFF signal for power sequencing

can be accomplished with no change to hardware. The standard behavior was chosen based on system design experience, but customers may have their own requirements. Please contact Bel Power for any special needs.

Remote Sense

The output voltage is regulated at the point where the sense pins connect to the power output pins. Total sense compensation should not exceed 0.4V or 2% of Vout, whichever is greater.

Safety

An external input fuse must always be used to meet these safety requirements.

External Output Trimming

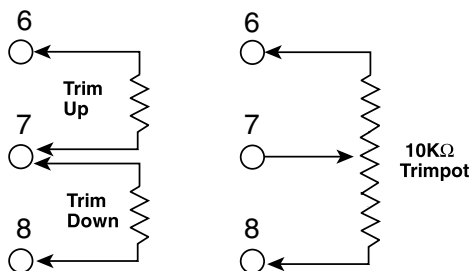

Trim

To trim the output voltage higher, connect the required trim resistor from the Trim pin to the +Sense pin. To trim the output voltage lower, connect the required trim resistor from the Trim pin to the -Sense pin. See diagram above.

Trim-up

$$R_{\text{TRIM-UP}} = \left\{ \frac{V_o (100+\Delta\%)}{1.225\Delta\%} - \frac{(100+2\Delta\%)}{\Delta\%} \right\} \text{ k}\Omega$$

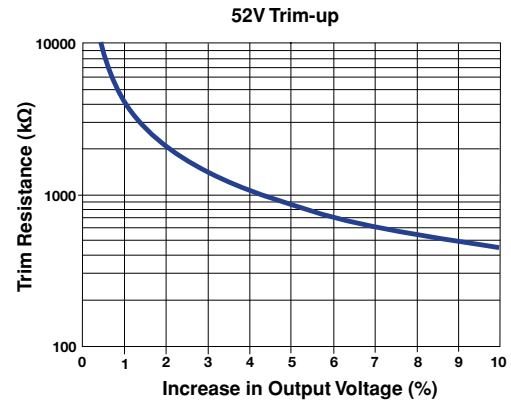

Trim-down

$$R_{\text{TRIM-DOWN}} = \left\{ \frac{100}{\Delta\%} - 2 \right\} \text{ k}\Omega$$

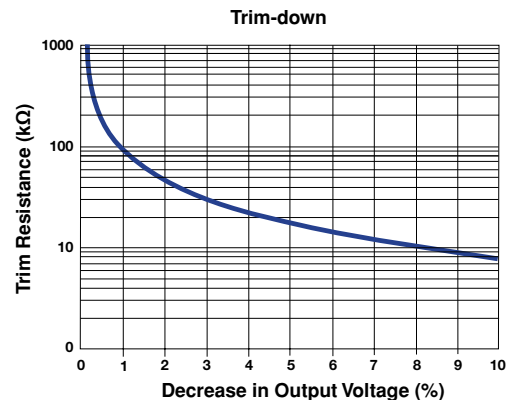

GPBW52V04

Efficiency Data

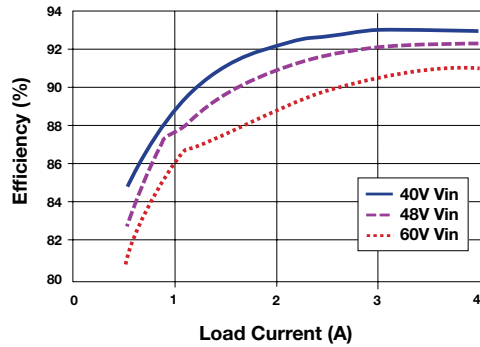

Power Dissipation

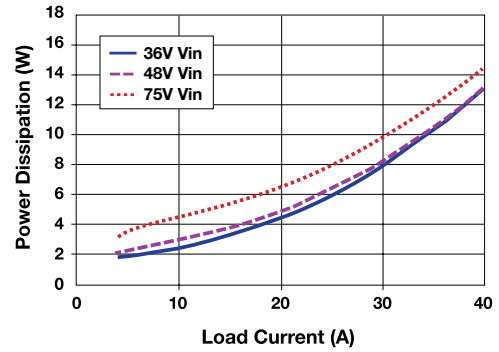

Start Up

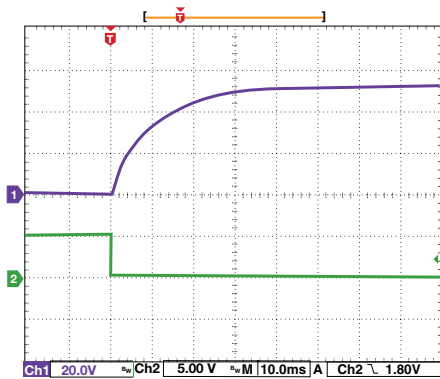

- 1. V_{OUT} 20V/div 10mS/div
- 2. V_{OUT} 5V/div 10mS/div

Voltage Ripple

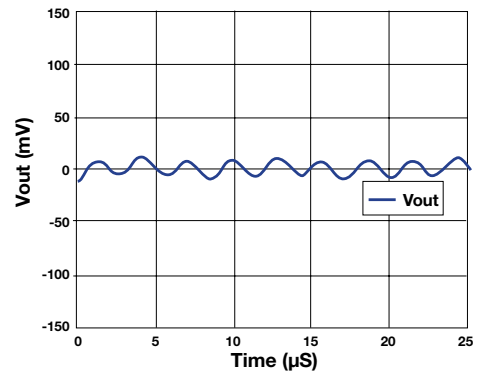

- 1. V_{OUT} 50mV/div 2µS/div
- 10µF ext cap 2MHz BW

Line/Load Regulation

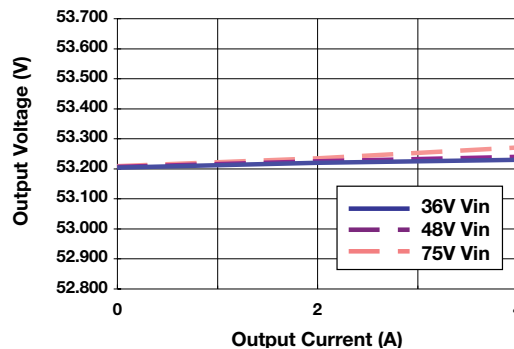

BOLERO HV DC/DC CONVERTERS

48V Input – 52VDC – 4A Output



GPBW52V04

Transient Response

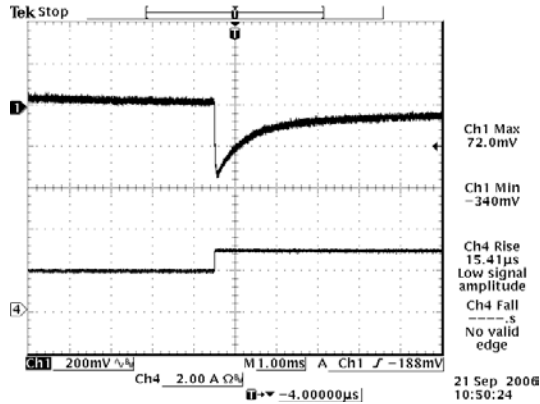

50% to 75% Load Transients
at $V_{IN} = 48V @ T_A = 25^{\circ}C$

Transient Response

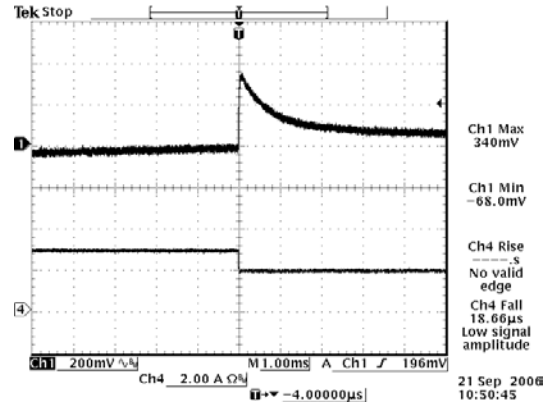

75% to 50% Load Transients
at $V_{IN} = 48V @ T_A = 25^{\circ}C$

BOLERO HV DC/DC CONVERTERS

48V Input – 52VDC – 4A Output



GPBW52V04

Mechanical

GPBW52V04

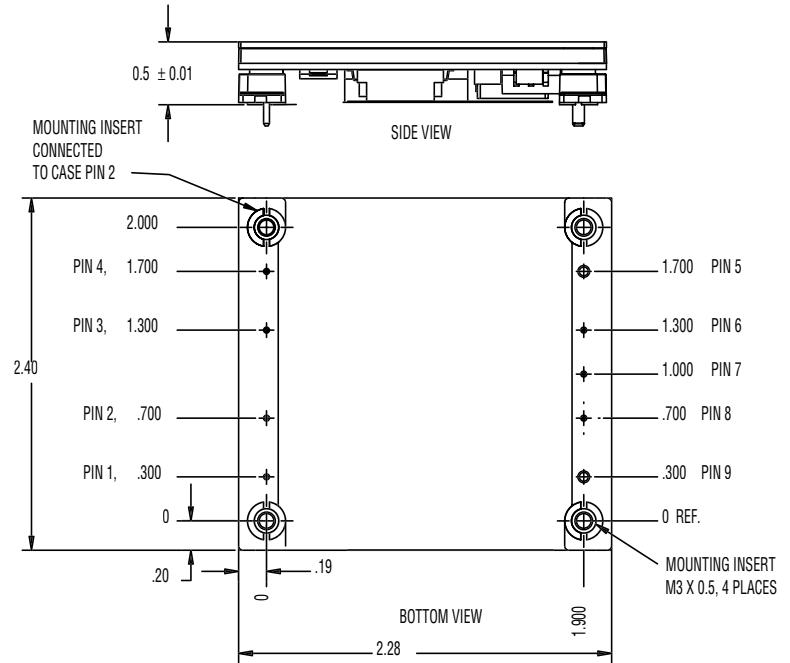

Pin Configuration – Bottom View

Pin	Function	Pin Dia. (In.)
1	- Input	0.040
2	Case Ground Pin	0.040
3	On/Off	0.040
4	+ Input	0.040
5	+ Output	0.080
6	+ Sense	0.040
7	Trim	0.040
8	- Sense	0.040
9	- Output	0.080

Notes:

- Mechanical tolerances
 x.xxx in. = ± 0.005 in.
 x.xx in = ± 0.01 in.
- Pin material: Brass with tin/lead plating over nickel
- Workmanship: Meets or exceeds IPC-A-610B Class II
- Min. screw length for heat sink attachment
 = 4.5mm + heat sink flange + locking hardware

RoHS Compliance

Complies with the European Directive 2002/95/EC, calling for the elimination of lead and other hazardous substances from electronic products. These parts are not however compatible with the higher temperatures associated with lead free solder processes and must be soldered using a reflow profile with a peak temperature of no more than 240°C.



©2006 Bel Fuse Inc. Specifications subject to change without notice. 11.06

CORPORATE

Bel Fuse Inc.
 206 Van Vorst Street
 Jersey City, NJ 07302
 Tel 201-432-0463
 Fax 201-432-9542
 www.belfuse.com

FAR EAST

Bel Fuse Ltd.
 8F / 8 Luk Hop Street
 San Po Kong
 Kowloon, Hong Kong
 Tel 852-2328-5515
 Fax 852-2352-3706
 www.belfuse.com

EUROPE

Bel Fuse Europe Ltd.
 Preston Technology Management Centre
 Marsh Lane, Suite G7, Preston
 Lancashire, PR1 8UD, U.K.
 Tel 44-1772-556601
 Fax 44-1772-888366
 www.belfuse.com