

NON-ISOLATED DC/DC CONVERTERS

2.4 Vdc - 5.5 Vdc Input 0.75 Vdc - 3.63 Vdc/3 A Output

bel
POWER PRODUCTS

SRBA-03F1Ax

RoHS Compliant

Rev.A

- Non-Isolated
- High Efficiency
- High Power Density
- Fixed Frequency (300 kHz)
- Converter Can Sink and Source Current
- OCP/SCP
- Remote On/Off
- Wide Trim Range
- Under-voltage Lockout (UVLO)



Description

The Bel SRBA-03F1Ax modules are a series of non-isolated dc/dc converters that deliver up to 3 A of output current with full load efficiency of 94% at 3.3 Vdc output. These modules provide precisely regulated voltage programmable via external resistor from 0.75 Vdc to 3.63 Vdc over a wide range of input voltage (2.4 Vdc - 5.5 Vdc). The open-frame construction and small footprint enable designers to develop cost and space-efficient solutions. Standard features include remote On/Off, over current protection, short circuit protection, under-voltage lockout, over temperature protection and programmable output voltage.

Part Selection

Output Voltage	Input Voltage	Max. Output Current	Max. Output Power	Typical Efficiency	Model Number Active Low	Model Number Active High
0.75 V - 3.63 V ¹	2.4 V - 5.5 V	3 A	10 W	94%	SRBA-03F1AL	SRBA-03F1A0

- Notes:**
1. These modules use a buck topology, so the output voltages must be 0.5 V less than the input voltage.
 2. Add "G" to the end of the Model Number to indicate Tray Packaging.
 3. All part numbers above indicate RoHS 6. Change the second letter "R" to "7" for RoHS 5 part numbers.

Absolute Maximum Ratings

Parameter	Min	Typ	Max	Notes
Input Voltage (continuous)	-0.3 V	-	5.8 V	
Output Enable Terminal Voltage	-0.3 V	-	5.5 V	
Ambient Temperature	-40 °C	-	85 °C	
Storage Temperature	-55 °C	-	125 °C	

Note: All specifications are typical at 25 °C unless otherwise stated.

NON-ISOLATED DC/DC CONVERTERS

2.4 Vdc - 5.5 Vdc Input

0.75 Vdc - 3.63 Vdc/3 A Output



Input Specifications

Parameter	Min	Typ	Max	Notes
Input Voltage	2.4 V	-	5.5 V	Vo, set ≤ Vin-0.5 V
Input Current (full load)				
Vo=3.3 V	-	2.11 A	-	
Vo=2.5 V	-	1.61 A	-	
Vo=2.0 V	-	1.32 A	-	
Vo=1.8 V	-	1.20 A	-	
Vo=1.5 V	-	1.01 A	-	
Vo=1.2 V	-	0.83 A	-	
Vo=0.75 V	-	0.55 A	-	
Input Current (no load)				
Vo=3.3 V	-	32 mA	-	
Vo=0.75 V	-	20 mA	-	
Remote Off Input Current	-	4 mA	-	
Input Reflected Ripple Current (pk-pk)	-	60 mA	-	Tested with simulated source impedance of 1 uH, 5 Hz to 20 MHz.
Input Reflected Ripple Current (rms)	-	18 mA	-	
I ² t Inrush Current Transient	-	-	0.04 A ² s	
Turn-on Voltage Threshold	-	2.05 V	2.4 V	
Turn-off Voltage Threshold	1.7 V	2.0 V	-	

Note: All specifications are typical at nominal input, full load at 25°C unless otherwise stated.

Output Specifications

Parameter	Min	Typ	Max	Notes
Output Voltage Set Point	-2%Vo,set	-	2%Vo,set	Vin=5 V, 50% full load
Output Voltage Set Point	-3%Vo,set	-	3%Vo,set	Over all operating input voltage, resistive load and temperature conditions until end of life.
Adjustment Range Selected by External Resistor or Voltage	0.7525 V	-	3.63 V	
Load Regulation	-	0.2%Vo,set	-	Io=Iomin to 50% Iomax
Line Regulation	-	0.2%Vo,set	-	Vin=Vinmin to Vinmax
Regulation Over Temperature (-40 °C to +85 °C)	-	0.4%Vo,set	-	
Output Current	0 A	-	3 A	
Current Limit Threshold	4 A	-	9.5 A	
Short Circuit Surge Transient	-	0.32 A ² s	-	
Ripple and Noise (pk-pk)	-	30 mV	50 mV	Tested with 0-20 MHz, with 10 uF tantalum capacitor & 1 uF/10 V ceramic capacitor at the output
Ripple and Noise (rms)	-	10 mV	15 mV	
Turn on Time	-	8 mS	12 mS	
Overshoot at Turn on	-	-	3%	
Output Capacitance				
ESR ≥ 1mohm	0 uF	-	1000 uF	
ESR ≥ 10mohm	0 uF	-	3000 uF	
Transient Response				
50% ~ 100% Max Load	Vo = 0.75 V -3.63 V	-	150 mV	di/dt=2.5 A/ uS; Vin=5 V; and with 10 uF tantalum capacitor & 1 uF/10 V TDK ceramic capacitor at the output
Settling Time		-	40 uS	
100% ~ 50% Max Load		-	150 mV	
Settling Time		-	40 uS	

Note: All specifications are typical at nominal input, full load at 25°C unless otherwise stated.

NON-ISOLATED DC/DC CONVERTERS

2.4 Vdc - 5.5 Vdc Input

0.75 Vdc - 3.63 Vdc/3 A Output



General Specifications

Parameter	Min	Typ	Max	Notes
Efficiency				Measured at Vin=5 V, full load
Vo=3.3 V	-	94%	-	
Vo=2.5 V	-	93%	-	
Vo=2.0 V	-	91%	-	
Vo=1.8 V	-	90%	-	
Vo=1.5 V	-	89%	-	
Vo=1.2 V	-	87%	-	
Vo=0.75 V	-	81.5%	-	
Switching Frequency	250 kHz	300 kHz	350 kHz	
Over Temperature Shutdown	-	135 °C	-	
Output Voltage Trim Range	0.7525 V	-	3.63 V	
MTBF	8,798,829 hours			Calculated Per Bell Core SR-332 (Vin=5 V; Vo=1.8 V, Io = 2.4 A; Ta = 25 °C)
Dimensions				
Inches (L × W × H)	0.8 x 0.45 x 0.27			
Millimeters (L × W × H)	20.32 x 11.42 x 6.87			
Weight	-	5 g	-	

Note: All specifications are typical at 25 °C unless otherwise stated.

Control Specifications

Parameter	Min	Typ	Max	Notes
Remote On/Off				
Signal Low (Unit Off)	-0.2 V	-	0.3 V	Active High: SRBA-03F1A0; Remote On/Off pin open, Unit on.
Signal High (Unit On)	-	-	Vin, max	
Signal Low (Unit On)	-0.2 V	-	0.3 V	Active Low: SRBA-03F1AL; Remote On/Off pin open, Unit on.
Signal High (Unit Off)	1.5 V	-	Vin, max	

NON-ISOLATED DC/DC CONVERTERS

2.4 Vdc - 5.5 Vdc Input

0.75 Vdc - 3.63 Vdc/3 A Output

bel
POWER PRODUCTS

Remote Enable Specifications

The SRBA-03F1AL modules feature an enable pin with negative logic. If not using the enable pin, leave the pin open (the module will be on). During logic_high, the module is turned off, during logic_low, the module is turned on. Its inner circuit impedance is shown as figure.

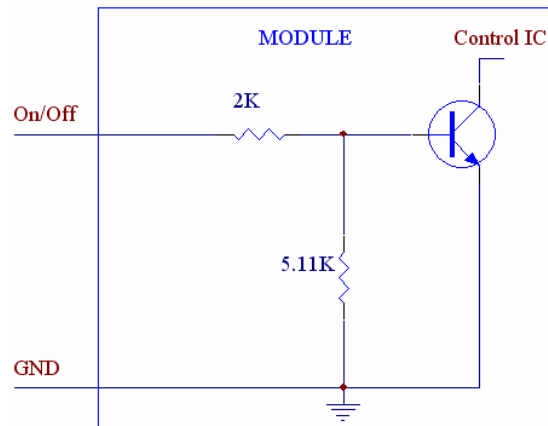

SRBA-03F1AL

The SRBA-03F1A0 modules feature an enable pin with Positive logic. If not using the enable pin, leave the pin open (the module will be on). During logic_high, the module is turned on, during logic_low, the module is turned off. Its inner circuit impedance is shown as figure.

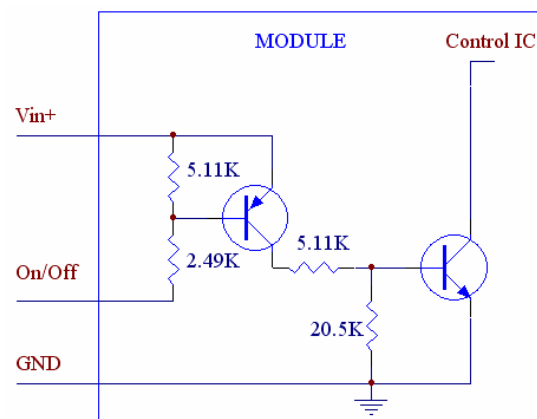

SRBA-03F1A0

NON-ISOLATED DC/DC CONVERTERS

2.4 Vdc - 5.5 Vdc Input

0.75 Vdc - 3.63 Vdc/3 A Output



Output Trim Equations

A: Equation for calculating the trim resistor (in kΩ) given the desired adjusted voltage (Vadj) is shown below. The Trim Up resistor should be connected between the Trim pin and Ground.

$$R_{trim} = \frac{21.07}{V_{adj} - 0.7525} - 5.11$$

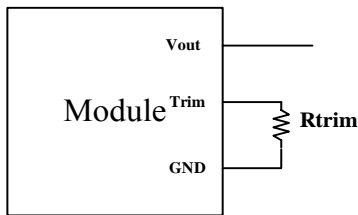
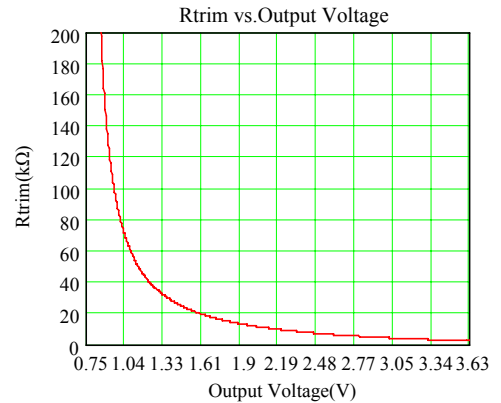

Table 1

Vo (V)	Rtrim (KΩ)
0.7525	Open
1.2	41.973
1.5	23.077
1.8	15.004
2.0	11.779
2.5	6.947
3.3	3.16



B: Equation for calculating the trim voltage (in V) given the desired adjusted voltage (Vadj) is shown below. The Trim Up voltage should be connected between the Trim pin and Ground.

$$V_{trim} = 0.7 - 0.1698 \times (V_{adj} - 0.7525)$$

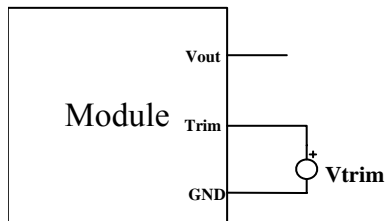
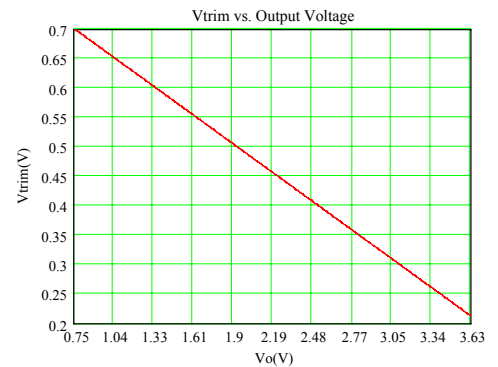
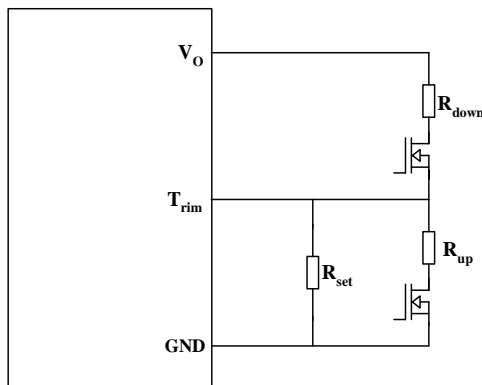

Table 2

Vo (V)	Vtrim (V)
0.7525	Open
1.2	0.624
1.5	0.5731
1.8	0.5221
2.0	0.4882
2.5	0.4033
3.3	0.267



C:



$$R_{set} = \frac{21.07}{V_o - 0.7525} - 5.11 \text{ K}\Omega$$

$$R_{up} = \frac{21.07 \cdot R_{set} - 5.11 \cdot V_{m_up} \cdot R_{set} + 3.845 \cdot R_{set}}{V_{m_up} \cdot R_{set} + 5.11 \cdot V_{m_up} - 0.753 R_{set} - 24.915} \text{ K}\Omega$$

Margin up value after output voltage is set with Rset

$$R_{down} = \frac{5.978 \cdot V_{m_down} \cdot R_{set} - 4.230 \cdot R_{set}}{0.128 \cdot R_{set} - 0.868 \cdot V_{m_down} - 0.170 \cdot V_{m_down} \cdot R_{set} + 4.230} \text{ K}\Omega$$

Margin down value after output voltage is set with Rset

$$V_{m_down} \geq 90\% V_o$$

Note: Output voltage $V_o = 0.7525$ V when Trim pin is not connected.

NON-ISOLATED DC/DC CONVERTERS

2.4 Vdc - 5.5 Vdc Input

0.75 Vdc - 3.63 Vdc/3 A Output



Efficiency Data

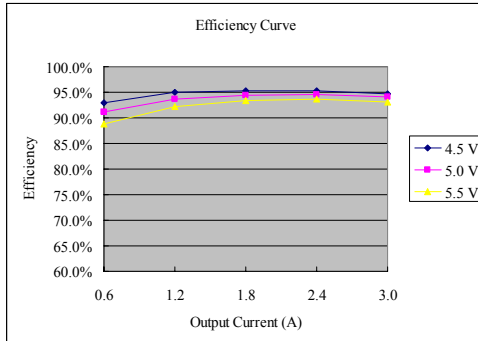

Vo=3.3 V

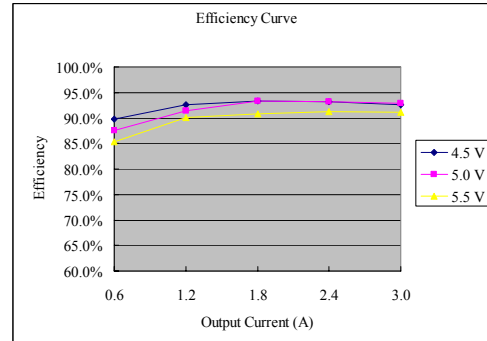

Vo=2.5 V

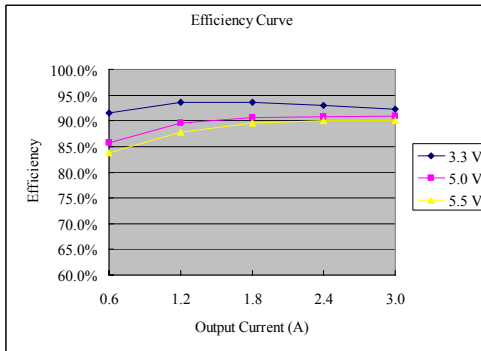

Vo=2.0 V

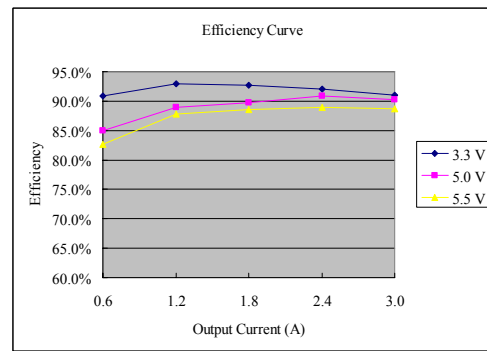

Vo=1.8 V

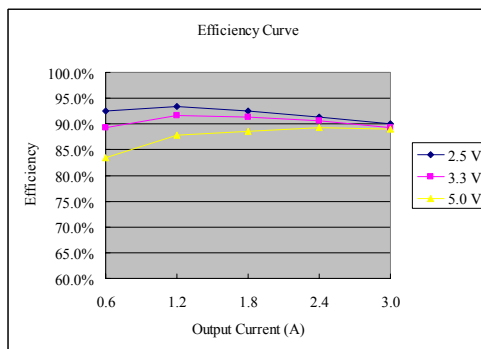

Vo=1.5 V

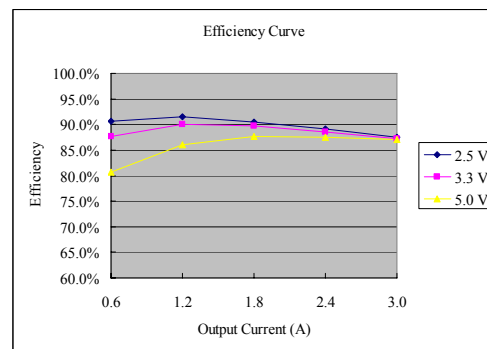

Vo=1.2 V

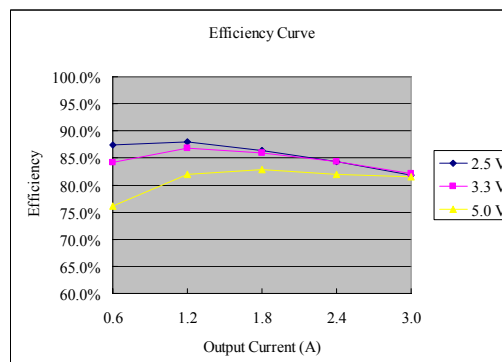

Vo=0.75 V

NON-ISOLATED DC/DC CONVERTERS

2.4 Vdc - 5.5 Vdc Input

0.75 Vdc - 3.63 Vdc/3 A Output



Thermal Derating Curve

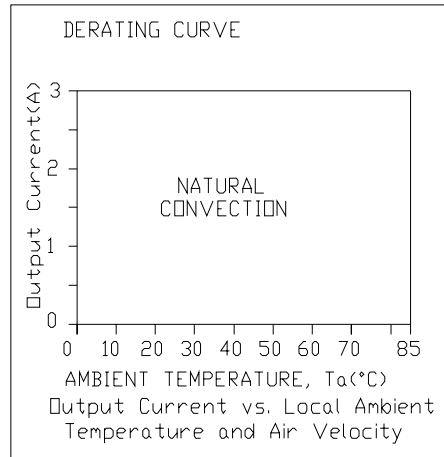

Ripple and Noise Waveforms

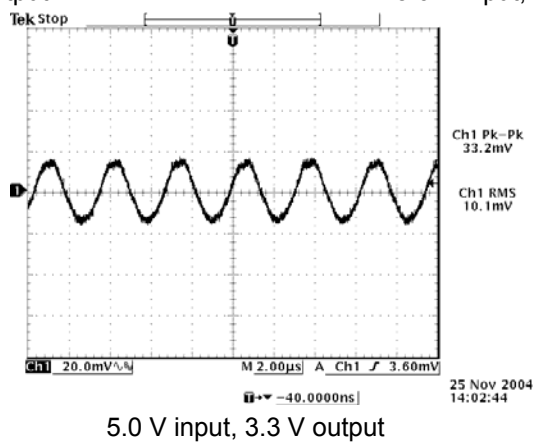
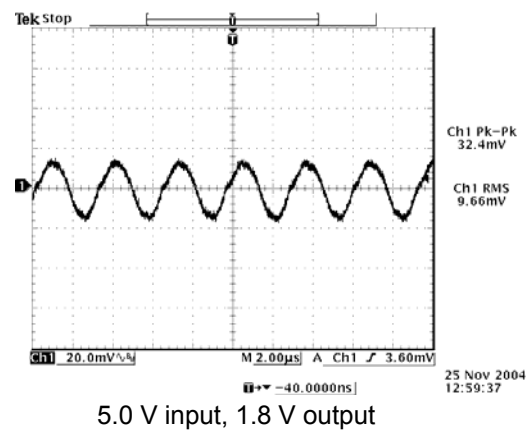
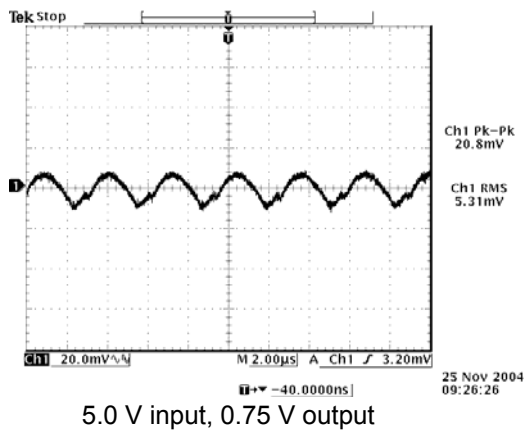

Note: Ripple and noise at full load, 0-20 MHz BW, 10 uF/10 V tantalum cap and 1 uF/10 V ceramic cap at the output, and Ta=25 deg C.

NON-ISOLATED DC/DC CONVERTERS

2.4 Vdc - 5.5 Vdc Input

0.75 Vdc - 3.63 Vdc/3 A Output



Transient Response Waveforms

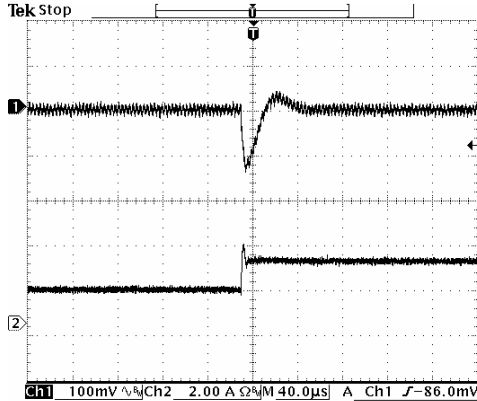

25 Nov 2004 09:21:40

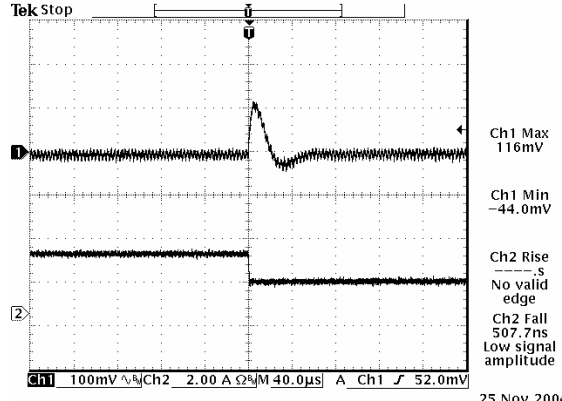

25 Nov 2004 09:21:56

Transients 50% to 100% load 0.75 Vdc output

Transients 100% to 50% load 0.75 Vdc output

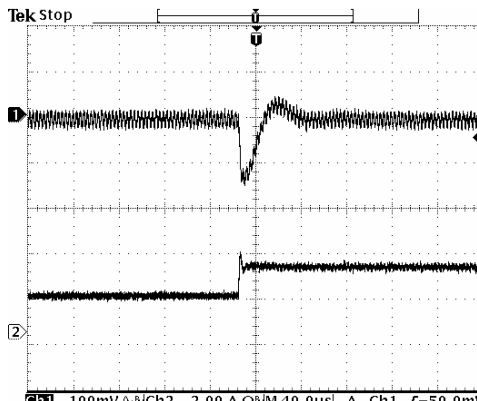

25 Nov 2004 12:55:57

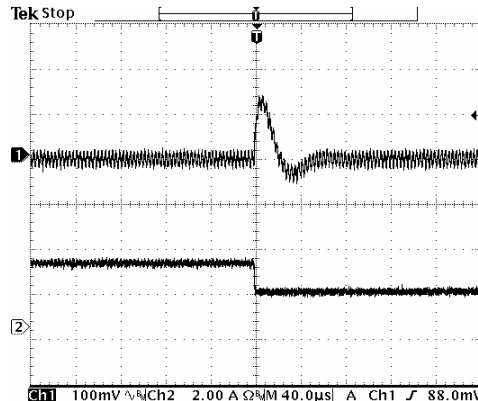

25 Nov 2004 12:56:24

Transients 50% to 100% load 1.8 Vdc output

Transients 100% to 50% load 1.8 Vdc output

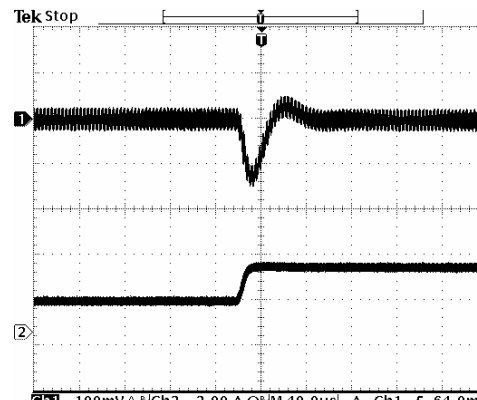

26 Nov 2004 15:59:14

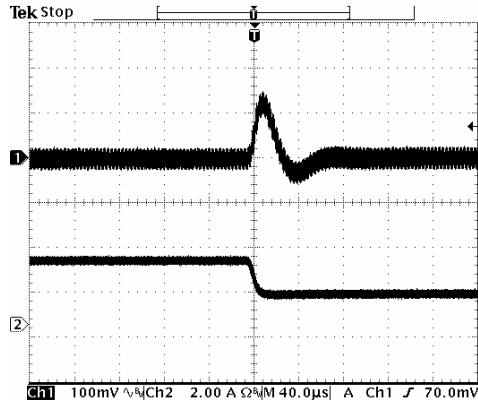

26 Nov 2004 15:59:29

Transients 50% to 100% load 3.3 Vdc output

Transients 100% to 50% load 3.3 Vdc output

Note: Transient response at 5 Vdc input, di/dt=2.5 A/µs, with 10 µF/10 V tantalum cap and 1 µF/10 V ceramic cap at the output, Ta=25 deg C.

NON-ISOLATED DC/DC CONVERTERS

2.4 Vdc - 5.5 Vdc Input

0.75 Vdc - 3.63 Vdc/3 A Output



Mechanical Outline

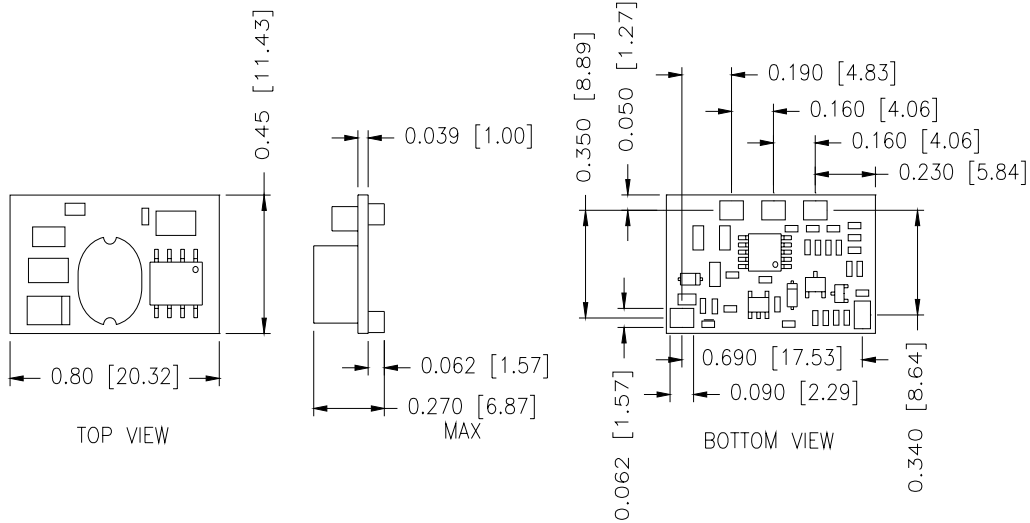

Recommended Pad Layout

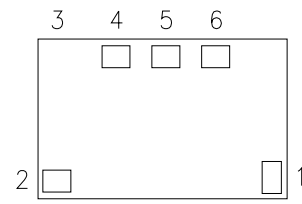
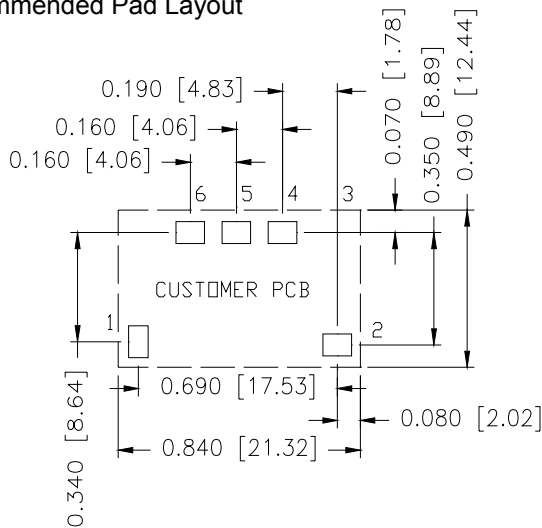

Pin Connections

Pin	Function
1	Remote On/Off
2	Vin+
3	N/A
4	Ground
5	Trim
6	Vout+

PAD SIZE: MIN: 0.12" * 0.095" (3.05mm * 2.41mm)

MAX: 0.135" * 0.11" (3.43mm * 2.79mm)

RoHS Compliance

Complies with the European Directive 2002/95/EC, calling for the elimination of lead and other hazardous substances from electronic products.



©2007 Bel Fuse Inc. Specifications subject to change without notice. 011707

CORPORATE

Bel Fuse Inc.
 206 Van Vorst Street
 Jersey City, NJ 07302
 Tel 201-432-0463
 Fax 201-432-9542
www.belfuse.com

FAR EAST

Bel Fuse Ltd.
 8F/ 8 Luk Hop Street
 San Po Kong
 Kowloon, Hong Kong
 Tel 852-2328-5515
 Fax 852-2352-3706
www.belfuse.com

EUROPE

Bel Fuse Europe Ltd.
 Preston Technology Management Centre
 Marsh Lane, Suite G7, Preston
 Lancashire, PR1 8UD, U.K.
 Tel 44-1772-556601
 Fax 44-1772-888366
www.belfuse.com