

NON-ISOLATED DC/DC CONVERTERS

8.3 Vdc - 14 Vdc Input

0.75 Vdc - 5.0 Vdc/6 A Output

bel
POWER PRODUCTS

SRBA-06A1Ax

RoHS Compliant

Rev.A

- Non-Isolated
- High Efficiency
- High Power Density
- Fixed Frequency
- Remote On/Off
- Under-Voltage Lockout (UVLO)
- OCP/SCP
- Wide Input Range
- Wide Output Trim Range
- Active Low/High



Description

The Bel SRBA-06A1Ax modules are a series of non-isolated dc/dc converters that deliver up to 6 A of output current with full load efficiency of 92% at 5.0 Vdc output. These modules provide precisely regulated voltage programmable via external resistor from 0.75 Vdc to 5.0 Vdc over a wide range of input voltage (8.3 Vdc - 14 Vdc). The open-frame construction and small footprint enable designers to develop cost and space-efficient solutions. Standard features include remote On/Off, over current protection, short current protection, wide input, and programmable output voltage.

Part Selection

Output Voltage	Input Voltage	Max. Output Current	Max. Output Power	Typical Efficiency	Model Number Active Low	Model Number Active High
0.75 V - 5.0 V	8.3 V - 14 V	6 A	30.0 W	92%	SRBA-06A1AL	SRBA-06A1A0

Notes: 1. Add "G" suffix at the end of the model number to indicate Tray Packaging.

2. All part numbers above indicate RoHS 6. Change the second letter "R" to "7" for RoHS 5 part numbers.

Absolute Maximum Ratings

Parameter	Min	Typ	Max	Notes
Input Voltage (continuous)	-0.3 V	-	15 V	
Output Enable Terminal Voltage	-0.3 V	-	15 V	
Ambient Temperature	-40 °C	-	85 °C	
Storage Temperature	-55 °C	-	125 °C	

Input Specifications

Parameter	Min	Typ	Max	Notes
Input Voltage	8.3 V	12 V	14 V	
Input Current (full load)				
Vo=5.0 V	-	2.75 A	4.0 A	
Vo=3.3 V	-	1.85 A	2.8 A	
Vo=2.5 V	-	1.45 A	2.2 A	
Vo=1.8 V	-	1.05 A	1.6 A	
Vo=1.2 V	-	0.75 A	1.1 A	
Vo=0.75 V	-	0.55 A	0.8 A	
Input Current (no load)				
Vo=5.0 V	-	-	100 mA	
Vo=0.75 V	-	-	20 mA	
Remote Off Input Current	-	1 mA	2 mA	
Input Reflected Ripple Current (pk-pk)	-	120 mA	-	Tested with two 100 uF/25 V tantalum input capacitors & simulated source impedance of 1 uH, 5 Hz to 20 MHz.
Input Reflected Ripple Current (rms)	-	40 mA	-	
I ² t Inrush Current Transient	-	0.002 A ² s	0.02 A ² s	
Turn-on Voltage Threshold	-	8.1 V	8.2 V	
Turn-off Voltage Threshold	-	7.5 V	8.0 V	

Note: All specifications are typical at 25 °C unless otherwise stated.

NON-ISOLATED DC/DC CONVERTERS

8.3 Vdc - 14 Vdc Input

0.75 Vdc - 5.0 Vdc/6 A Output



Output Specifications

Parameter	Min	Typ	Max	Notes	
Output Voltage Set Point	-2% Vo,set	-	2% Vo,set	Vin=12 V, full load	
Output Voltage Set Point	-2.5% Vo,set	-	3.5% Vo,set	Over all operating input voltages, resistive loads and temperature conditions	
Adjustment Range Selected by External Resistor or Voltage	0.7525 V	-	5.0 V		
Load Regulation	-	0.4% Vo,set	-	Io=Iomin to Iomax	
Line Regulation	-	0.3% Vo,set	-	Vin= Vinmin to Vinmax	
Regulation Over Temperature (-40 °C to +8 °C)	-	0.5% Vo,set	-	Tref=Tamin to Tamax	
Output Current	0A	-	6A		
Current Limit Threshold	7.2A	-	18A		
Short Circuit Surge Transient	-	0.25A ² s	-		
Ripple and Noise (pk-pk) Vo=0.75 V-3.63 V	-	50 mV	75 mV	Tested with 0-20MHz, with 10 uF/10 V tantalum capacitor & 1 uF/10 V TDK ceramic capacitor at the output.	
Ripple and Noise (rms) Vo=0.75 V-3.63 V	-	15 mV	30 mV		
Ripple and Noise (pk-pk) Vo=5.0 V	-	75 mV	100 mV		
Ripple and Noise (rms) Vo=5.0 V	-	30 mV	40 mV		
Turn on Time	-	8 mS	10 mS		
Overshoot at Turn on	-	0%	3%		
Output Capacitance					
ESR ≥ 1 mohm	0 uF	-	1000 uF		
ESR ≥ 10 mohm	0 uF	-	3300 uF		
Transient Response					
50% ~ 100% Max Load	Vo = 0.75 V -5 V	-	200 mV	-	di/dt=2.5 A/uS; Vin=12 V; and With 10 uF/10 V tantalum capacitor & 1 uF/10 V ceramic capacitor at the output.
Settling Time		-	50 uS	-	
100% ~ 50% Max Load		-	200 mV	-	
Settling Time		-	50 uS	-	

Note: All specifications are typical at nominal input, full load at 25 °C unless other wise stated.

General Specifications

Parameter	Min	Typ	Max	Notes
Efficiency				Measured at Vin=12 V, full load
Vo=5.0 V	90%	92%	-	
Vo=3.3 V	87%	89%	-	
Vo=2.5 V	85%	88%	-	
Vo=1.8 V	83%	86%	-	
Vo=1.2 V	79%	82%	-	
Vo=0.75 V	71%	74%	-	
Switching Frequency	250 kHz	300 kHz	350 kHz	
Over Temperature Shutdown	-	135 °C	-	
Output Trim Range (Wide trim)	0.7525 V	-	5 V	
MTBF	3,079,469 hours			Calculated Per Bell Core SR-332 (Io = Nominal; Ta = 25 °C)
Dimensions				
Inches (L x W x H)	0.8 x 0.45 x 0.251			
Millimeters (L x W x H)	20.32 x 11.42 x 6.38			
Weight	-	3 g	-	

Note: All specifications are typical at 25 °C unless other wise stated.

NON-ISOLATED DC/DC CONVERTERS

8.3 Vdc - 14 Vdc Input

0.75 Vdc - 5.0 Vdc/6 A Output



Control Specifications

Parameter	Min	Typ	Max	Notes
Remote On/Off				
Signal Low (Unit Off)	-0.3 V	-	0.4 V	SRBA-06A1A0; Remote On/Off pin open, Unit on.
Signal High (Unit On)	2.5 V	-	14 V	
Signal Low (Unit On)	-0.3 V	-	0.4 V	SRBA-06A1AL; Remote On/Off pin open, Unit on.
Signal High (Unit Off)	2.5 V	-	14 V	

Remote Enable Specifications

The SRBA-06A1AL modules feature an enable pin with negative logic. If not using the enable pin, leave the pin open (the module will be on). During logic_high, the module is turned off, during logic_low, the module is turned on. Its inner circuit impedance is shown as figure.

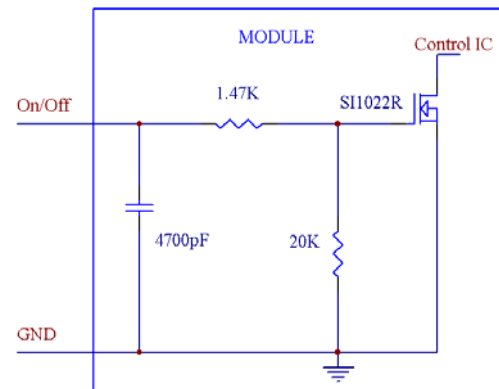

SRBA-06A1AL

The SRBA-06A1A0 modules feature an enable pin with Positive logic. If not using the enable pin, leave the pin open (the module will be on). During logic_high, the module is turned on, during logic_low, the module is turned off. Its inner circuit impedance is shown as figure.

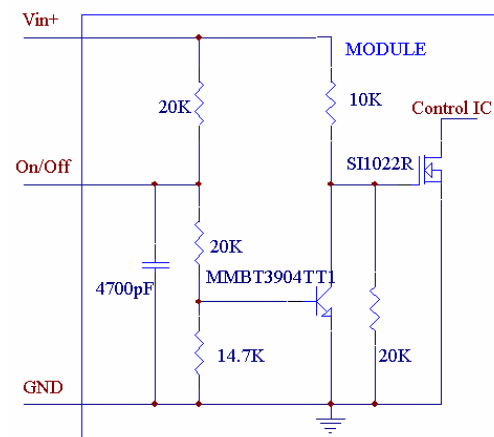

SRBA-06A1A0

NON-ISOLATED DC/DC CONVERTERS

8.3 Vdc - 14 Vdc Input

0.75 Vdc - 5.0 Vdc/6 A Output

bel
POWER PRODUCTS

Output Trim Equations

Equation for calculating the trim resistor (in kΩ) given the desired adjusted voltage (V_{adj}) is shown below. The Trim Up resistor should be connected between the Trim pin and Ground.

$$R_{trim} = \frac{10.507}{V_{adj} - 0.7525} - 1$$

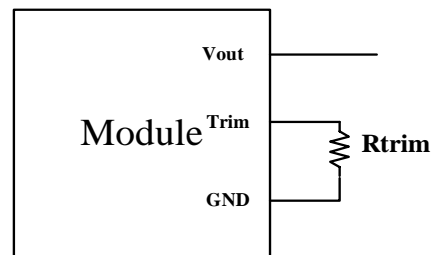

Equation for calculating the trim voltage (in V) given the desired adjusted voltage (V_{adj}) is shown below. The Trim Up voltage should be connected between the Trim pin and Ground.

$$V_{trim} = 0.7 - 0.0667 \times (V_{adj} - 0.7525)$$

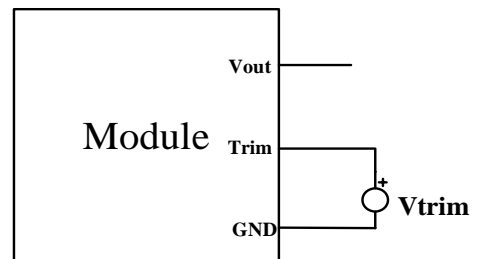

NON-ISOLATED DC/DC CONVERTERS

8.3 Vdc - 14 Vdc Input

0.75 Vdc - 5.0 Vdc/6 A Output



Efficiency Data

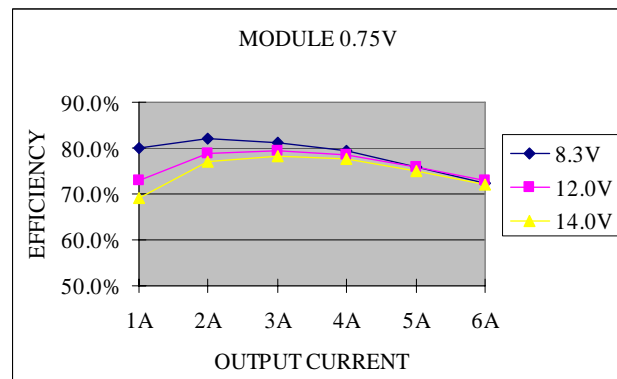
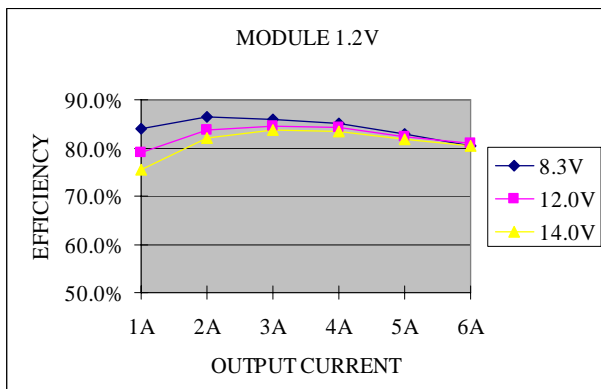
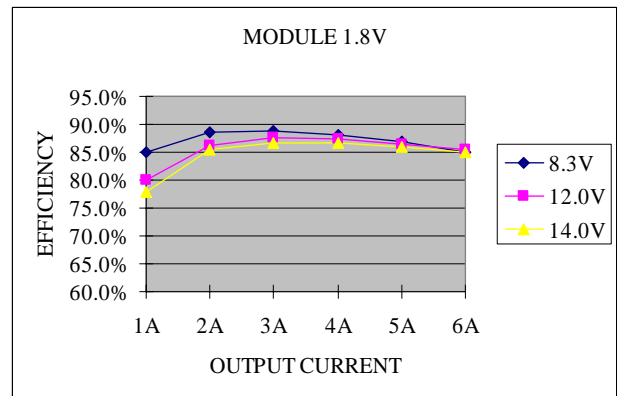
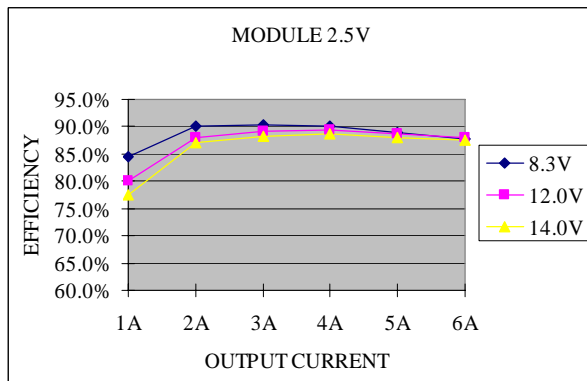
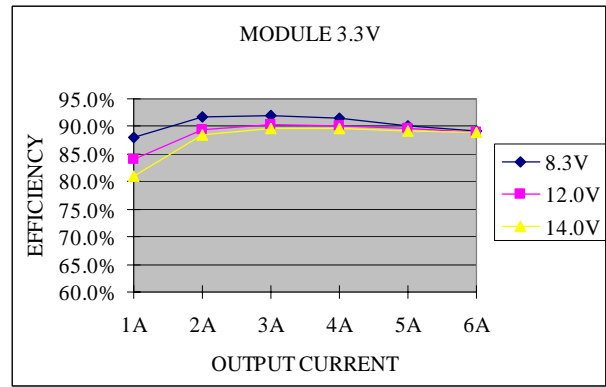
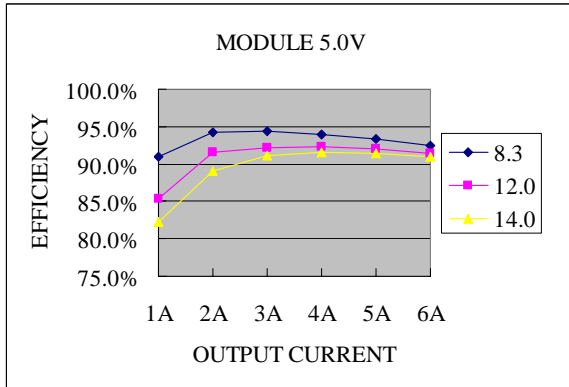

NON-ISOLATED DC/DC CONVERTERS

8.3 Vdc - 14 Vdc Input

0.75 Vdc - 5.0 Vdc/6 A Output



Thermal Derating Curves

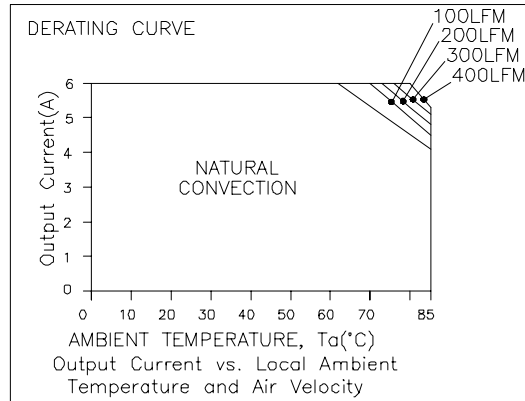

$V_{in}=12\text{ V}$, $V_o=0.75\text{ V}$

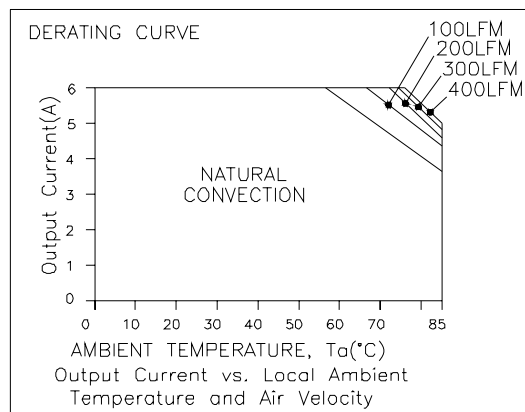

$V_{in}=12\text{ V}$, $V_o=2.5\text{ V}$

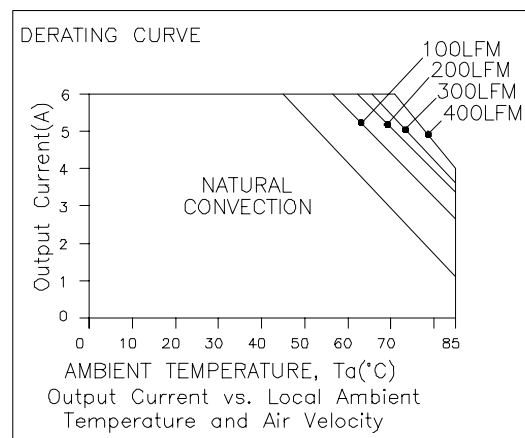

$V_{in}=12\text{ V}$, $V_o=5.0\text{ V}$

NON-ISOLATED DC/DC CONVERTERS

8.3 Vdc - 14 Vdc Input

0.75 Vdc - 5.0 Vdc/6 A Output



Ripple and Noise Waveforms

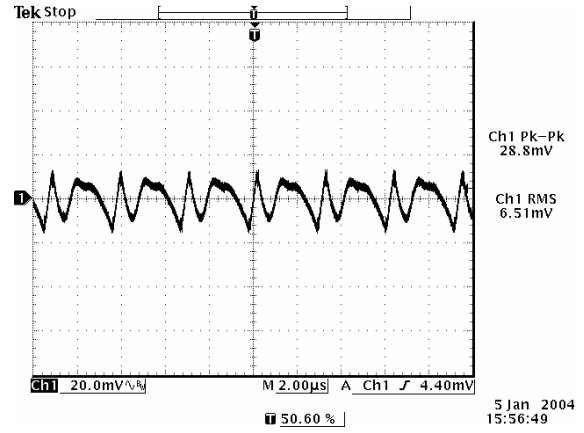
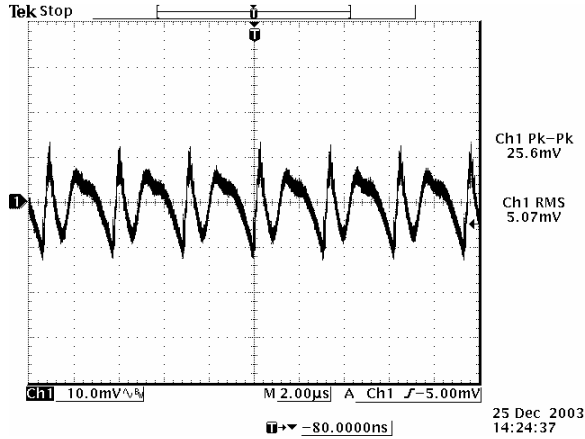

Ripple and noise at full load, $V_{in}=12\text{ V}$, $V_o=0.75\text{ V}$

Ripple and noise at full load, $V_{in}=12\text{ V}$, $V_o=1.2\text{ V}$

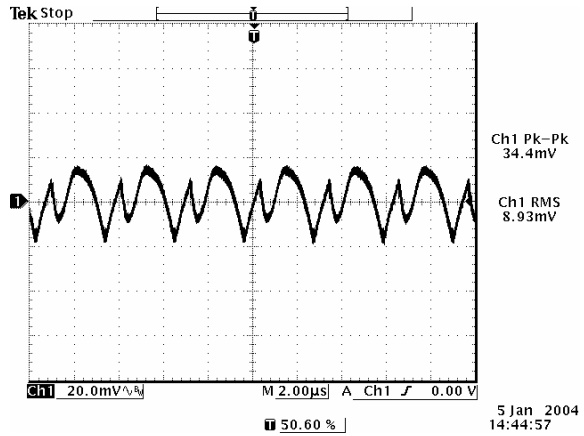
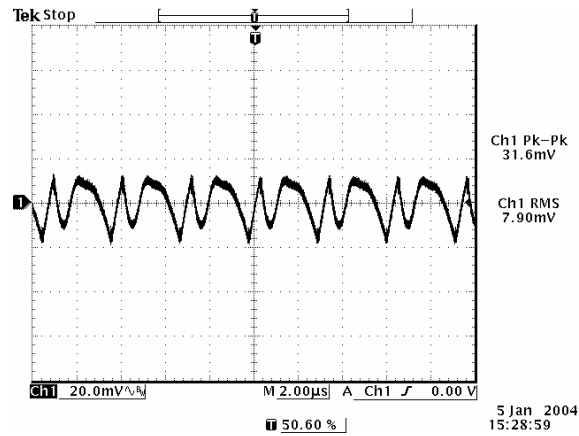

Ripple and noise at full load, $V_{in}=12\text{ V}$, $V_o=1.8\text{ V}$

Ripple and noise at full load, $V_{in}=12\text{ V}$, $V_o=2.5\text{ V}$

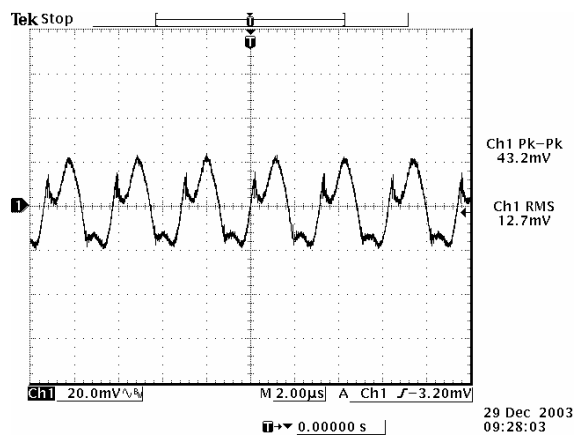
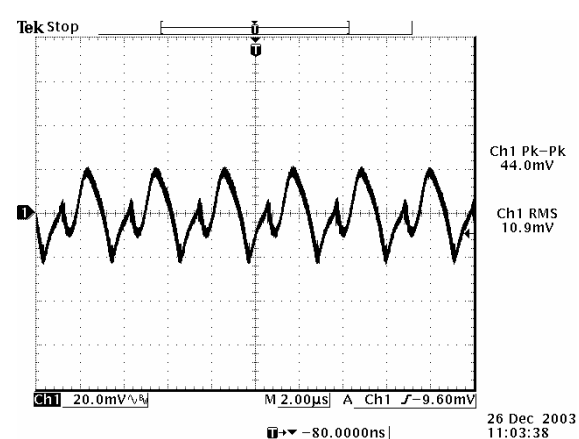

Ripple and noise at full load, $V_{in}=12\text{ V}$, $V_o=3.3\text{ V}$

Ripple and noise at full load, $V_{in}=12\text{ V}$, $V_o=5.0\text{ V}$

Note: The output ripple and noise is tested at 0-20 MHz BW, 10 $\mu\text{F}/10\text{ V}$ tantalum capacitor and 1 $\mu\text{F}/10\text{ V}$ ceramic capacitor, $T_a=25\text{ deg C}$.

NON-ISOLATED DC/DC CONVERTERS

8.3 Vdc - 14 Vdc Input

0.75 Vdc - 5.0 Vdc/6 A Output



Transient Response Waveforms

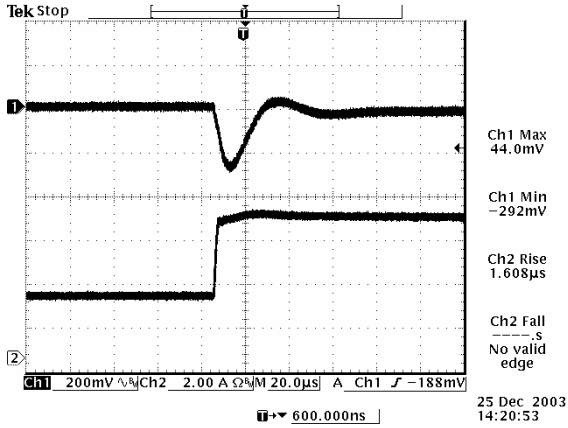

50% to 100% load step at $V_{in}=12\text{ V}$, $V_o=0.75\text{ V}$

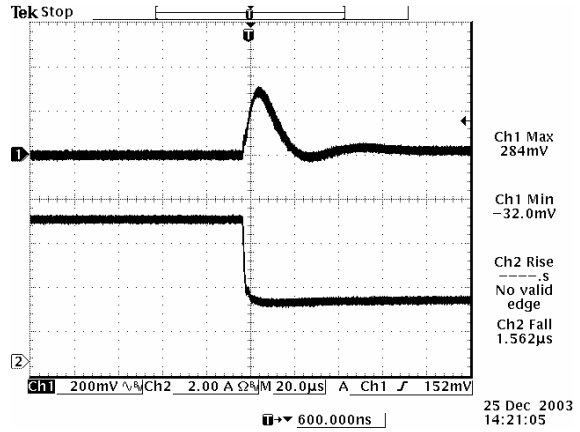

100% to 50% load step at $V_{in}=12\text{ V}$, $V_o=0.75\text{ V}$

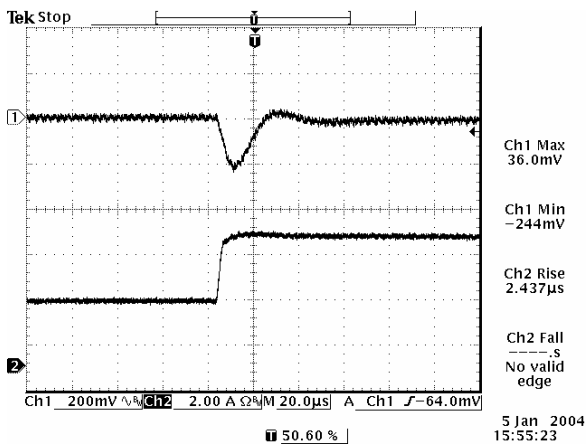

50% to 100% load step at $V_{in}=12\text{ V}$, $V_o=1.2\text{ V}$

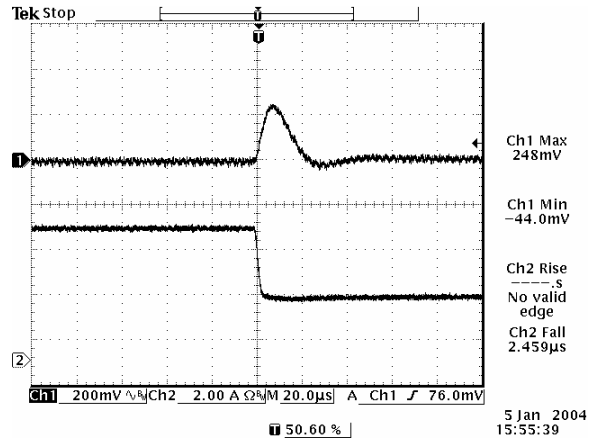

100% to 50% load step at $V_{in}=12\text{ V}$, $V_o=1.2\text{ V}$

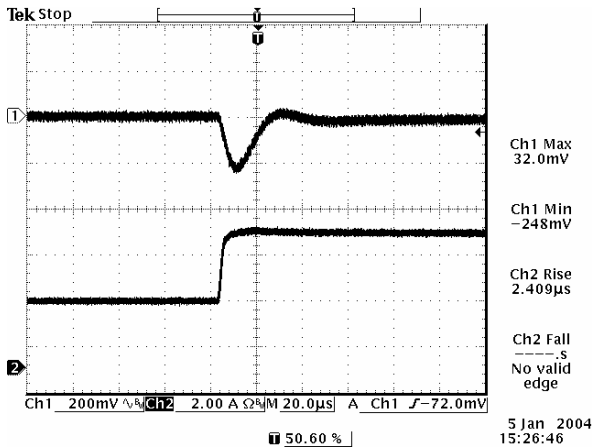

50% to 100% load step at $V_{in}=12\text{ V}$, $V_o=1.8\text{ V}$

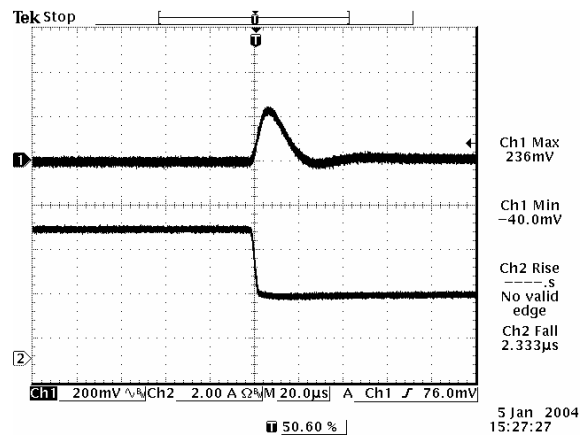

100% to 50% load step at $V_{in}=12\text{ V}$, $V_o=1.8\text{ V}$

NON-ISOLATED DC/DC CONVERTERS

8.3 Vdc - 14 Vdc Input

0.75 Vdc - 5.0 Vdc/6 A Output



Transient Response Waveforms (continued)

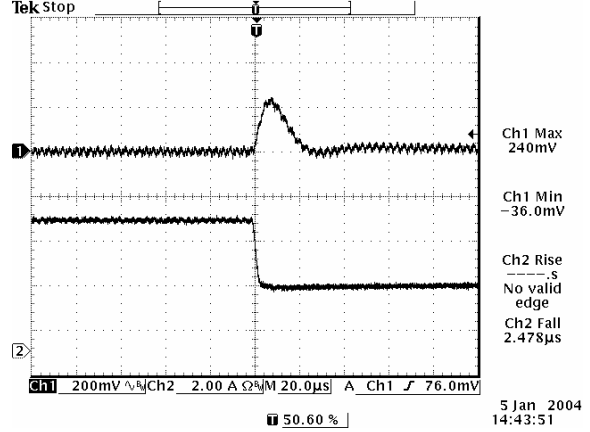
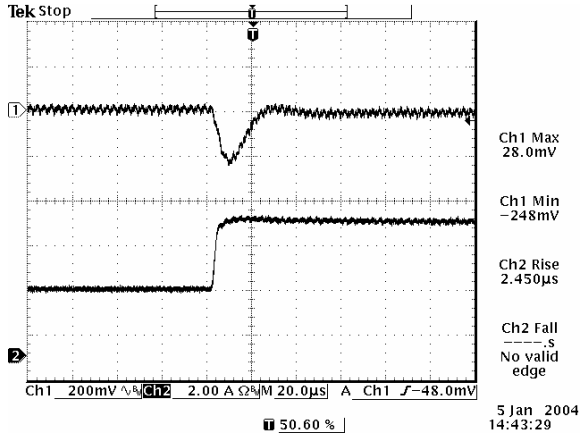

50% to 100% load step at $V_{in}=12\text{ V}$, $V_o=2.5\text{ V}$

100% to 50% load step at $V_{in}=12\text{ V}$, $V_o=2.5\text{ V}$

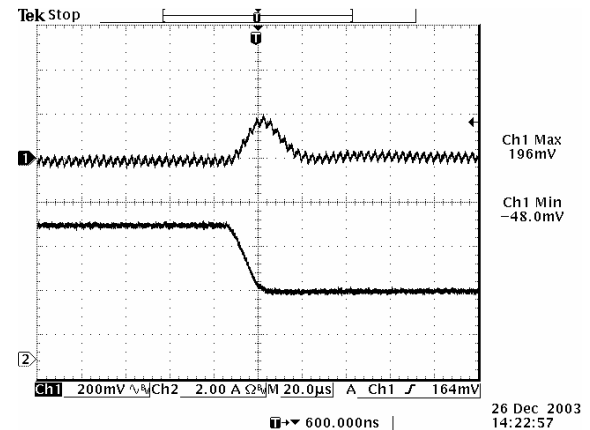
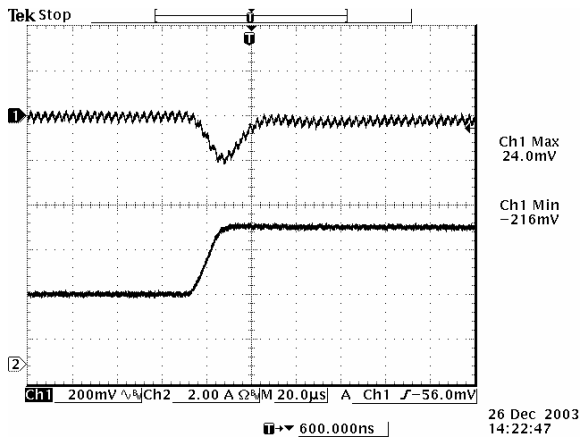

50% to 100% load step at $V_{in}=12\text{ V}$, $V_o=3.3\text{ V}$

100% to 50% load step at $V_{in}=12\text{ V}$, $V_o=3.3\text{ V}$

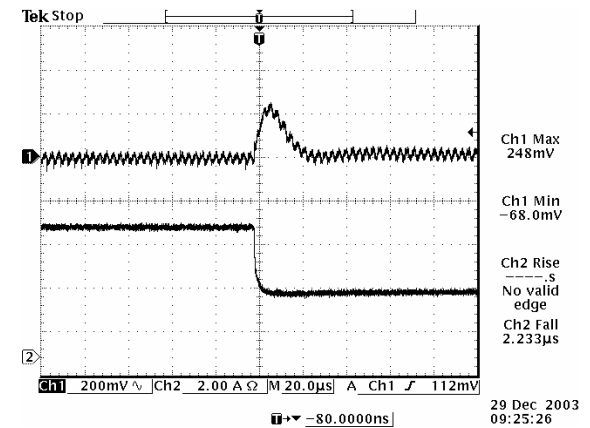
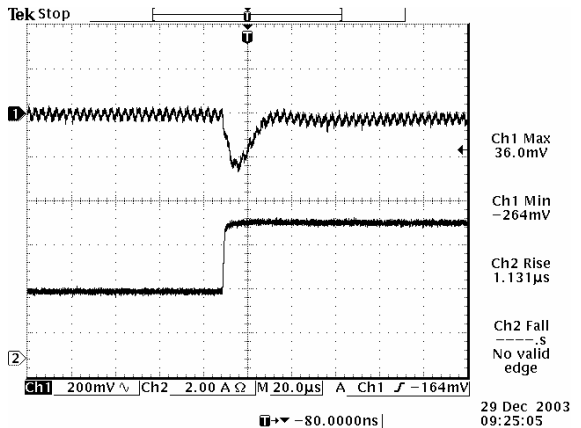

50% to 100% load step at $V_{in}=12\text{ V}$, $V_o=5.0\text{ V}$

100% to 50% load step at $V_{in}=12\text{ V}$, $V_o=5.0\text{ V}$

Note: Transient response is tested at $di/dt=2.5\text{ A}/\mu\text{S}$, with $10\text{ }\mu\text{F}/10\text{ V}$ tantalum capacitor and $1\text{ }\mu\text{F}/10\text{ V}$ ceramic capacitor, $T_a=25\text{ deg C}$.

NON-ISOLATED DC/DC CONVERTERS

8.3 Vdc - 14 Vdc Input

0.75 Vdc - 5.0 Vdc/6 A Output



Mechanical Outline

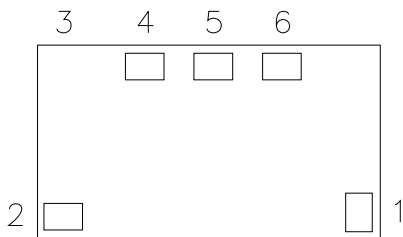
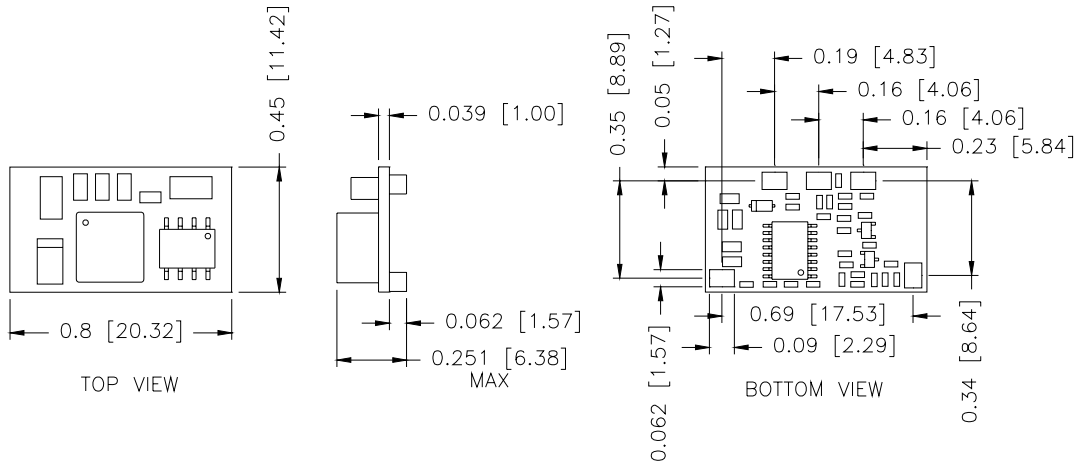

Pin Connections

Pin	Function
1	Remote On/Off
2	Vin+
3	No Pin
4	Ground
5	Trim
6	Vout+

RECOMMENDED PAD LAYOUT

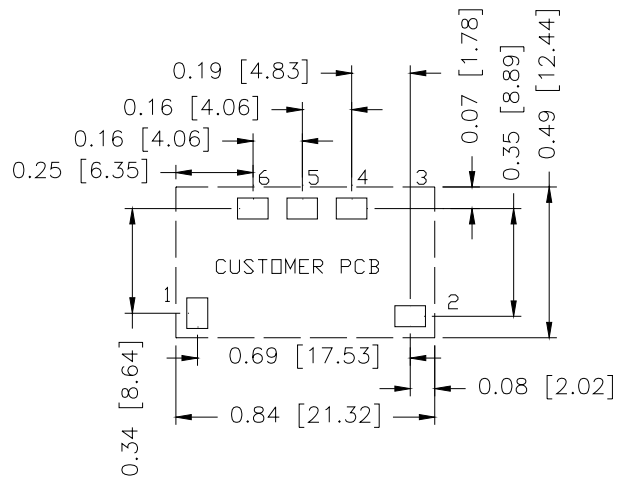

PAD SIZE:

MIN: 0.12" * 0.095" (3.05mm * 2.41mm)

MAX: 0.135" * 0.11" (3.43mm * 2.79mm)

RoHS Compliance

Complies with the European Directive 2002/95/EC, calling for the elimination of lead and other hazardous substances from electronic products. These parts are not however compatible with the higher temperatures associated with lead free solder processes and must be soldered using a reflow profile with a peak temperature of no more than 240°C



©2007 Bel Fuse Inc. Specifications subject to change without notice. 011207

CORPORATE

Bel Fuse Inc.
 206 Van Vorst Street
 Jersey City, NJ 07302
 Tel 201-432-0463
 Fax 201-432-9542
WWW.belfuse.com

FAR EAST

Bel Fuse Ltd.
 8F/ 8 Luk Hop Street
 San Po Kong
 Kowloon, Hong Kong
 Tel 852-2328-5515
 Fax 852-2352-3706
WWW.belfuse.com

EUROPE

Bel Fuse Europe Ltd.
 Preston Technology Management Centre
 Marsh Lane, Suite G7, Preston
 Lancashire, PR1 8UD, U.K.
 Tel 44-1772-556601
 Fax 44-1772-888366
WWW.belfuse.com