

NON-ISOLATED DC/DC CONVERTERS

8.3 Vdc - 14 Vdc Input

0.75 Vdc - 5.0 Vdc/10 A Output

bel
POWER PRODUCTS

SRBC-10A1Ax

RoHS Compliant

Rev.A

- Non-Isolated
- High Efficiency
- High Power Density
- Excellent Thermal Performance
- Low Cost
- Flexible Output Voltage
- Remote Sense
- Able to Sink/Source Current
- Under-voltage Lockout (UVLO)
- Over Temperature Protection
- OCP/SCP
- Wide Input
- Wide Trim
- Remote On/Off
- Active Low/High (option)
- Industrial Temperature Range



Description

The Bel SRBC-10A1Ax modules are a series of non-isolated dc/dc converters that deliver up to 10 A of output current with full load efficiency of 93% at 3.3 V output. These modules provide precisely regulated voltage programmable via external resistor from 0.75 V to 5.0 V over a wide range of input voltage (8.3 V - 14 V). The open-frame construction and small footprint enable designers to develop cost and space-efficient solutions. Standard features include remote On/Off, over current protection, short current protection, wide input, and programmable output voltage.

Part Selection

Output Voltage	Input Voltage	Max. Output Current	Max. Output Power	Typical Efficiency	Model Number Active Low	Model Number Active High
0.75 V - 5.0 V	8.3 V - 14 V	10 A	50.0 W	95%	SRBC-10A1AL	SRBC-10A1A0

- Notes:** 1. Add "G" suffix at the end of the model number to indicate "Tray Packaging".
2. All part numbers above indicate RoHS 6. Change the second letter "R" to "7" for RoHS 5 part numbers.

Absolute Maximum Ratings

Parameter	Min	Typ	Max	Notes
Input Voltage (continuous)	-0.3 V	-	15 V	
Output Enable Terminal Voltage	-0.3 V	-	15 V	
Ambient Temperature	-40 °C	-	85 °C	
Storage Temperature	-55 °C	-	125 °C	

Note: All specifications are typical at 25 °C unless otherwise stated.

NON-ISOLATED DC/DC CONVERTERS

8.3 Vdc - 14 Vdc Input

0.75 Vdc - 5.0 Vdc/10 A Output



Input Specifications

Parameter	Min	Typ	Max	Notes
Input Voltage				
Vo, set ≤ 3.63 V	8.3 V	12 V	14 V	
Vo, set > 3.63 V	8.3 V	12 V	13.2 V	
Input Current (full load)	-	-	6.5 A	An input line fuse must always be used.
Input Current (no load)	-	50 mA	-	
Remote Off Input Current	-	2 mA	-	
Input Reflected Ripple Current (pk-pk)	-	-	400 mA	Tested with one 1000uF/25 V AL input capacitor with ESR=0.03 ohm max and 4 × 47 uF/16 V tan capacitors with ESR=0.013 ohm max at 100 kHz, & simulated source impedance of 1000 nH, 5 Hz to 20 MHz.
Input Reflected Ripple Current (rms)	-	-	150 mA	
I ² t Inrush Current Transient	-	0.04 A ² s	0.08 A ² s	
Turn-on Voltage Threshold	-	8.2 V		
Turn-off Voltage Threshold	-	7.9 V		

Note: All specifications are typical at 25 °C unless otherwise stated.

Output Specifications

Parameter	Min	Typ	Max	Notes	
Output Voltage Set Point	-2% Vo,set	-	2% Vo,set	Vin=12 V, full load	
Load Regulation	-	0.1% Vo,set	-		
Line Regulation	-	0.1% Vo,set	-		
Regulation Over Temperature (-40 °C to +85 °C)	-	0.3% Vo,set	-	Tref=Tamin to Tamax	
Output Current	0 A	-	10 A		
Current Limit Threshold	-	200% Io,out	-		
Short Circuit Surge Transient	-	1 A ² s	3 A ² s		
Ripple and Noise (pk-pk)	-	50 mV	100 mV	Tested with 0-20 MHz, with 10 uF tantalum capacitor & 1 F ceramic capacitor	
Ripple and Noise (rms)	-	20 mV	40 mV		
Turn on Time	-	6 mS	10 mS		
Overshoot at Turn on	-	0%	1%		
Output Capacitance ESR ≥ 10 mohm	0 uF	-	5000 uF		
Transient Response					
50% ~ 100% Max Load	Vo = 0.75 V - 5 V	-	100 mV	-	di/dt=2.5 A/uS; Vin=12 V; and with 2 × 150 uF polymer capacitors at the output
Settling Time		-	50 uS	-	
100% ~ 50% Max Load		-	100 mV	-	
Settling Time		-	50 uS	-	

Note: All specifications are typical at nominal input, full load at 25 °C unless otherwise stated.

NON-ISOLATED DC/DC CONVERTERS

8.3 Vdc - 14 Vdc Input

0.75 Vdc - 5.0 Vdc/10 A Output



General Specifications

Parameter	Min	Typ	Max	Notes
Efficiency				Measured at $V_{in}=12\text{ V}$, full load
$V_o=5.0\text{ V}$	-	95%	-	
$V_o=3.3\text{ V}$	-	93%	-	
$V_o=2.5\text{ V}$	-	92%	-	
$V_o=1.8\text{ V}$	-	90%	-	
$V_o=1.5\text{ V}$	-	89%	-	
$V_o=1.2\text{ V}$	-	87.5%	-	
$V_o=0.75\text{ V}$	-	81%	-	
Switching Frequency	265 kHz	300 kHz	335 kHz	
Over Temperature Shutdown ¹	-	130 °C	-	
Output Voltage Trim Range	0.7525 V	-	5.0 V	
Remote Sense Compensation	-	-	0.5 V	
Dimensions				
Inches (L x W x H)	1.3 x 0.53 x 0.315			
Millimeters (L x W x H)	33.02 x 13.46 x 8.00			
Weight	-	8 g	-	

Notes: All specifications are typical at 25 °C unless otherwise stated.

1. The Tref temperature measurement location:

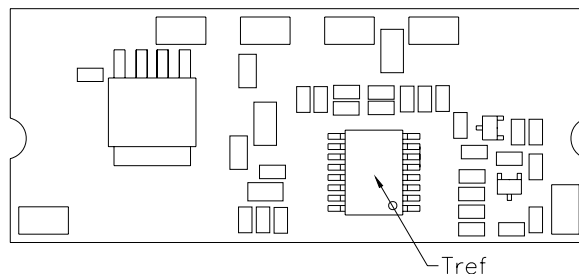

Control Specifications

Parameter	Min	Typ	Max	Notes
Remote On/Off				
Signal Low (Unit Off)	-0.2 V	-	0.3 V	SRBC-10A1A0; Remote On/Off pin open, Unit on.
Signal High (Unit On)	-	-	$V_{in, \text{max}}$	
Signal Low (Unit On)	-0.2 V	-	0.3 V	SRBC-10A1AL; Remote On/Off pin open, Unit on.
Signal High (Unit Off)	2.5 V	-	$V_{in, \text{max}}$	

NON-ISOLATED DC/DC CONVERTERS

8.3 Vdc - 14 Vdc Input

0.75 Vdc - 5.0 Vdc/10 A Output

bel
POWER PRODUCTS

Remote Enable Specifications

The SRBC-10A1AL modules feature an enable pin with negative logic. If not using the enable pin, leave the pin open (the module will be on). During logic_high, the module is turned off, during logic_low, the module is turned on. Its inner circuit impedance is shown as figure.

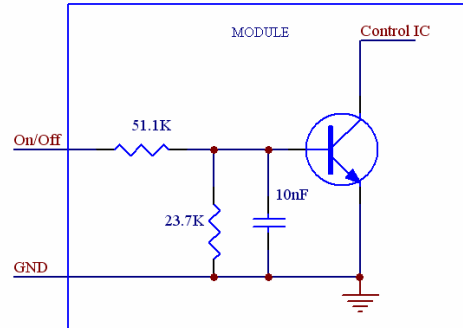

SRBC-10A1AL

The SRBC-10A1A0 modules feature an enable pin with Positive logic. If not using the enable pin, leave the pin open (the module will be on). During logic_high, the module is turned on, during logic_low, the module is turned off. Its inner circuit impedance is shown as figure.

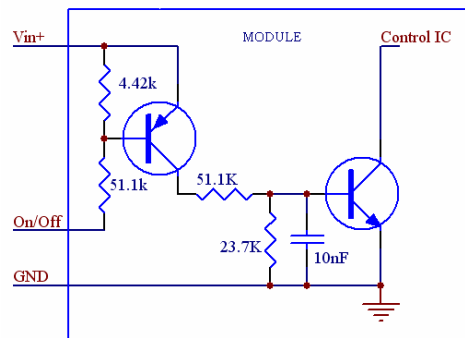

SRBC-10A1A0

Output Trim Equations

Equation for calculating the trim resistor (in Ω) given the desired adjusted voltage (V_{adj}) is shown below. The Trim Up resistor should be connected between the Trim pin and Ground.

$$R_{trimup} = \frac{10500}{V_{adj} - 0.7525} - 1000$$

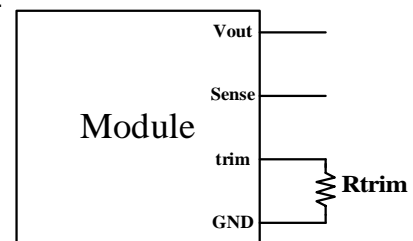

Equation for calculating the trim voltage (in V) given the desired adjusted voltage (V_{adj}) is shown below. The Trim Up voltage should be connected between the Trim pin and Ground.

$$V_{trimup} = 0.7 - 0.0667 \times (V_{adj} - 0.7525)$$

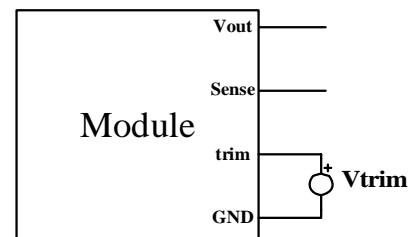

NON-ISOLATED DC/DC CONVERTERS

8.3 Vdc - 14 Vdc Input

0.75 Vdc - 5.0 Vdc/10 A Output



Thermal Derating Curves

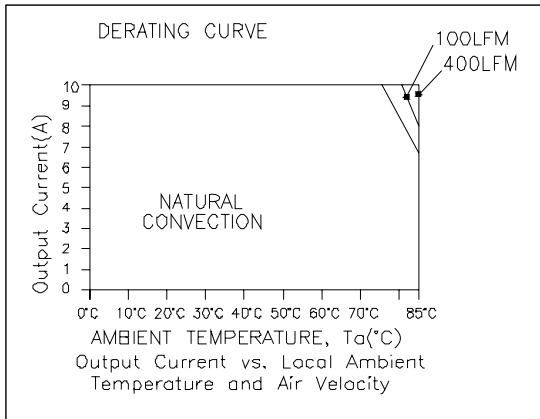

SRBC-10A1AL, Vo=0.75 V

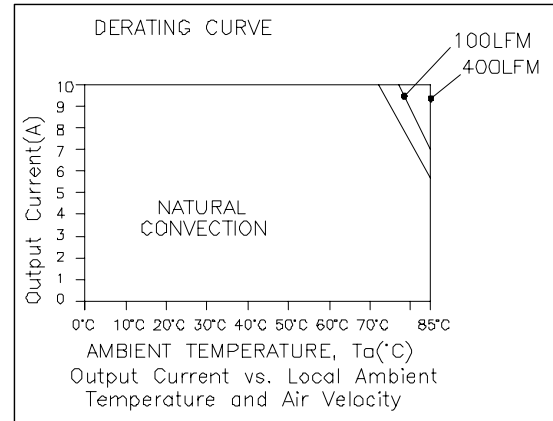

SRBC-10A1AL, Vo=1.8 V

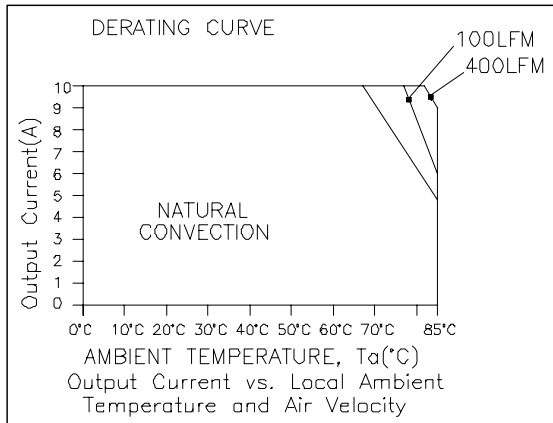

SRBC-10A1AL, Vo=3.3 V

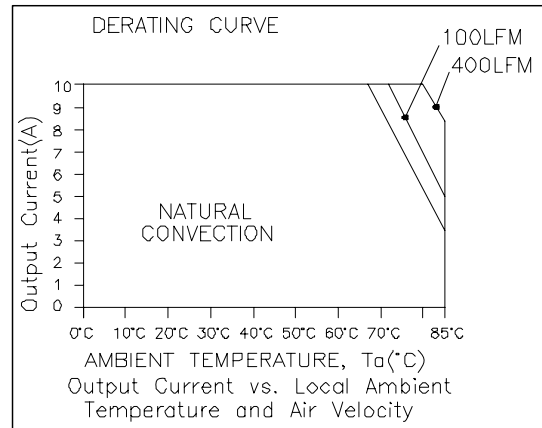

SRBC-10A1AL, Vo=5.0 V

NON-ISOLATED DC/DC CONVERTERS

8.3 Vdc - 14 Vdc Input

0.75 Vdc - 5.0 Vdc/10 A Output



Efficiency Data

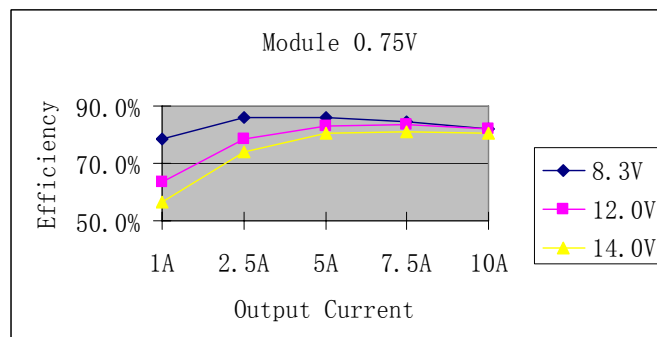
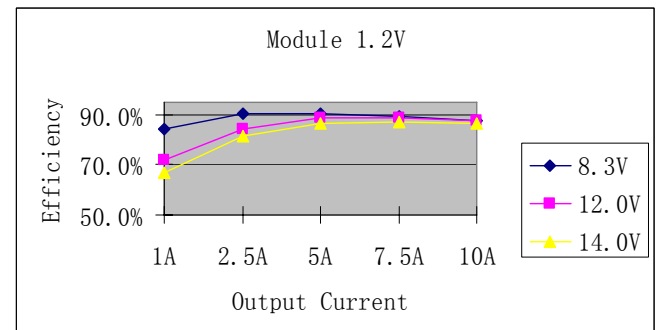
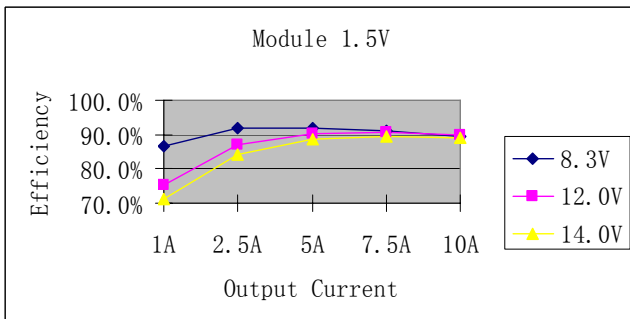
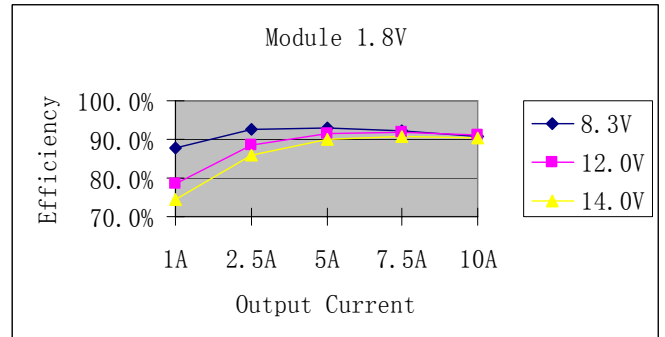
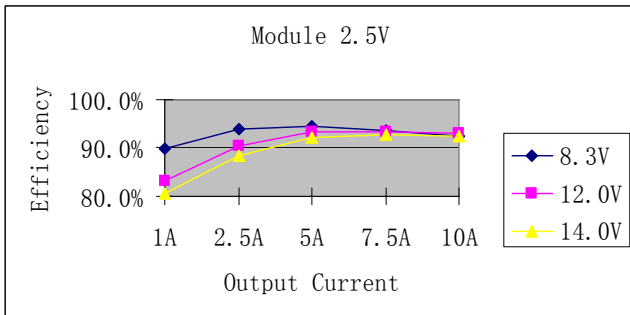
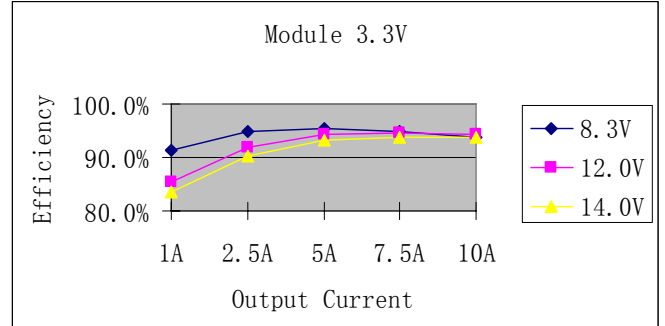
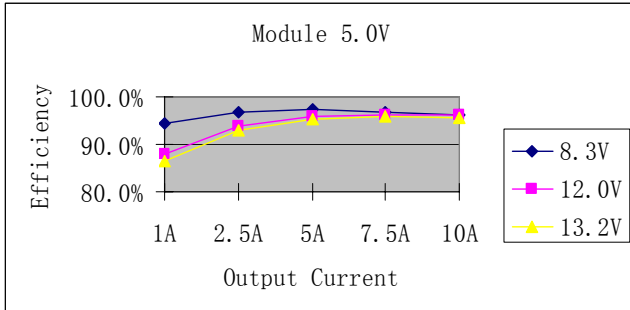

NON-ISOLATED DC/DC CONVERTERS

8.3 Vdc - 14 Vdc Input

0.75 Vdc - 5.0 Vdc/10 A Output



Ripple and Noise Waveforms

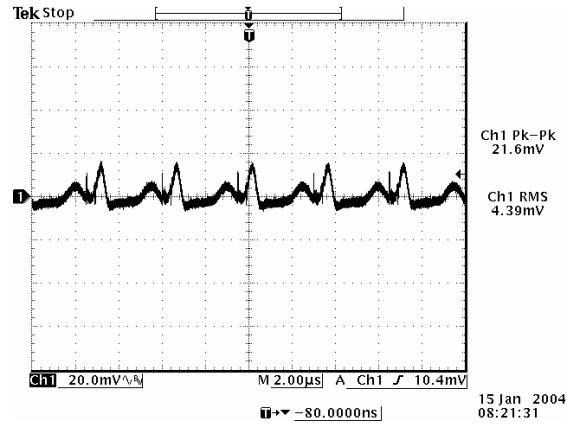
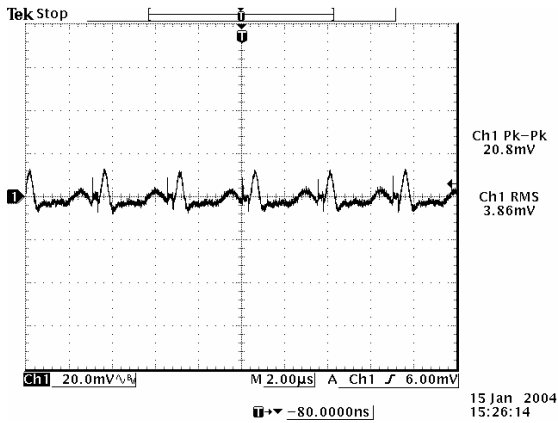

Ripple and noise at max load 0.75 Vdc output

Ripple and noise at max load 1.2 Vdc output

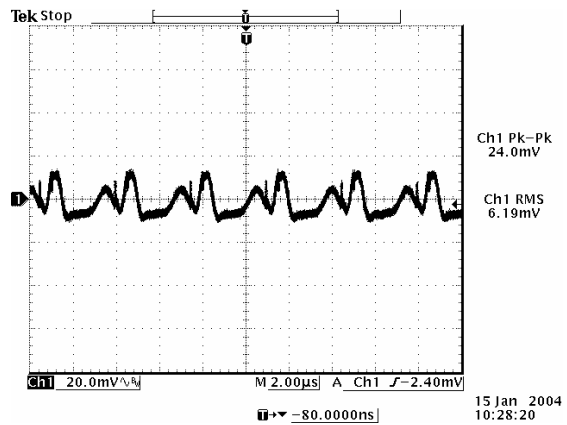
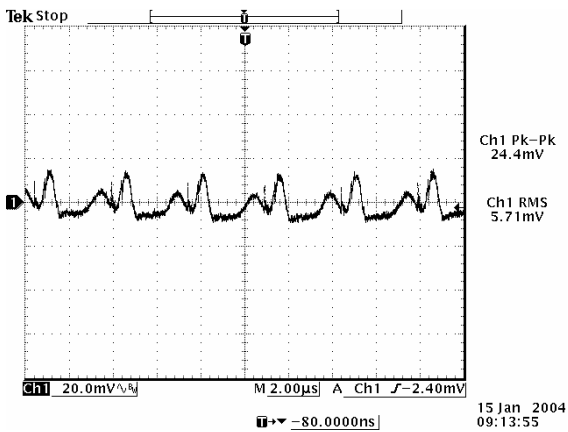

Ripple and noise at max load 1.5 Vdc output

Ripple and noise at max load 1.8 Vdc output

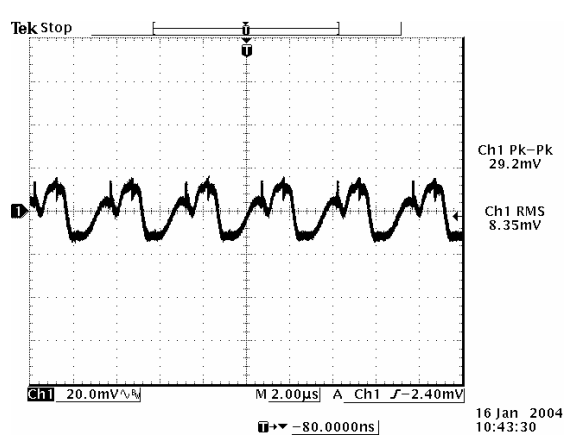
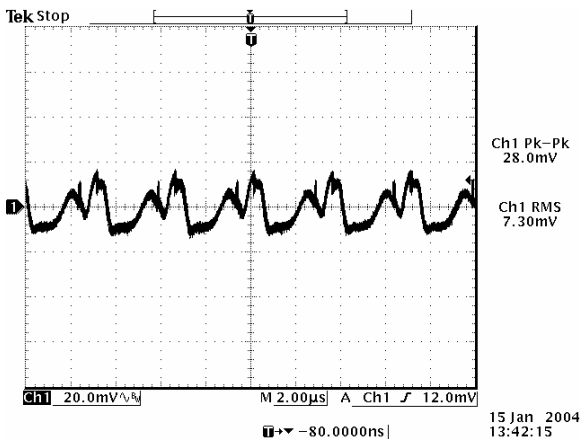

Ripple and noise at max load 2.5 Vdc output

Ripple and noise at max load 3.3 Vdc output

NON-ISOLATED DC/DC CONVERTERS

8.3 Vdc - 14 Vdc Input

0.75 Vdc - 5.0 Vdc/10 A Output



Ripple and Noise Waveforms (continued)

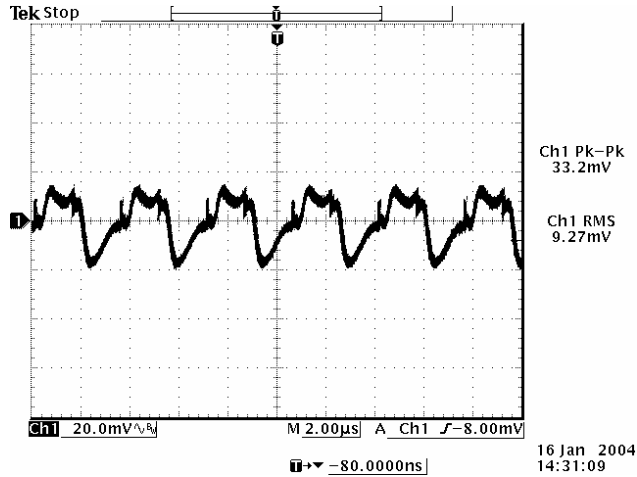

Ripple and noise at max load 5.0 Vdc output

Note: Ripple and Noise at 12 V input, with 10 µF tantalum capacitor and 1 µF ceramic capacitor at the output, and Ta=25 deg C.

Transient Response Waveforms

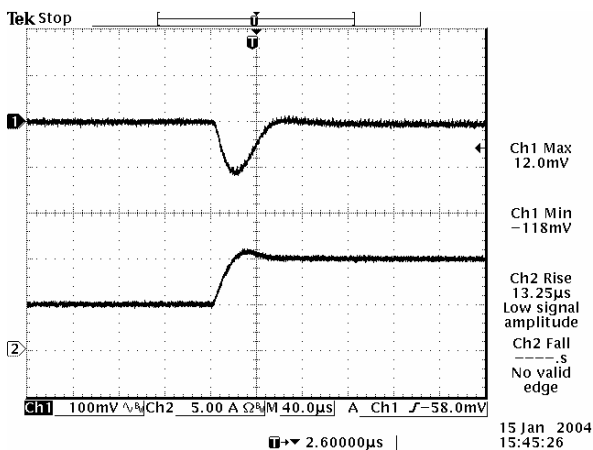

Transients 50% to 100% load 0.75 Vdc output

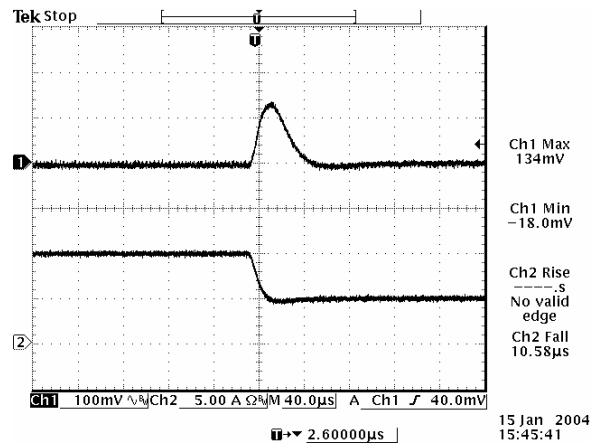

Transients 100% to 50% load 0.75 Vdc output

NON-ISOLATED DC/DC CONVERTERS

8.3 Vdc - 14 Vdc Input

0.75 Vdc - 5.0 Vdc/10 A Output



Transient Response Waveforms (continued)

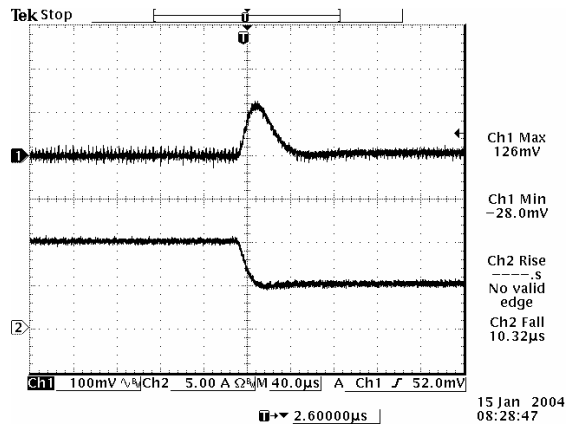
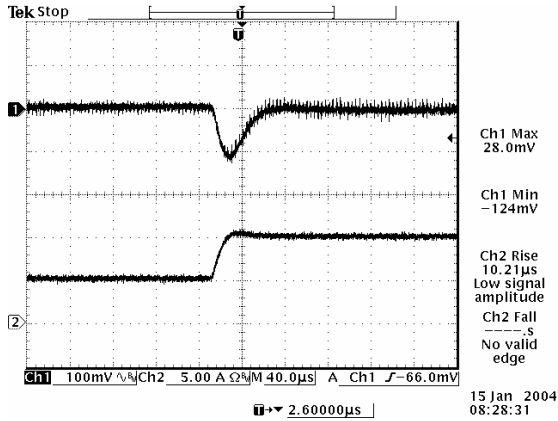

Transients 50% to 100% load 1.2 Vdc output

Transients 100% to 50% load 1.2 Vdc output

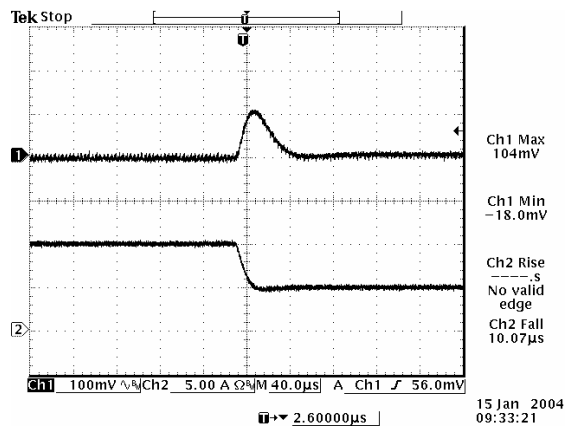
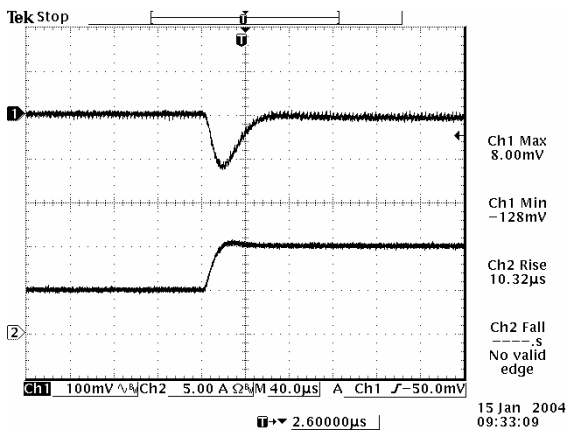

Transients 50% to 100% load 1.5 Vdc output

Transients 100% to 50% load 1.5 Vdc output

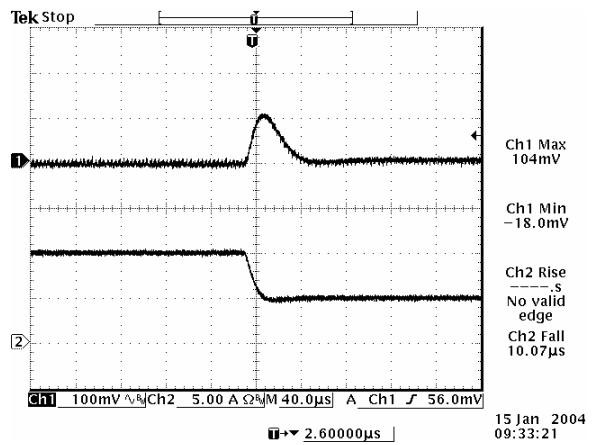
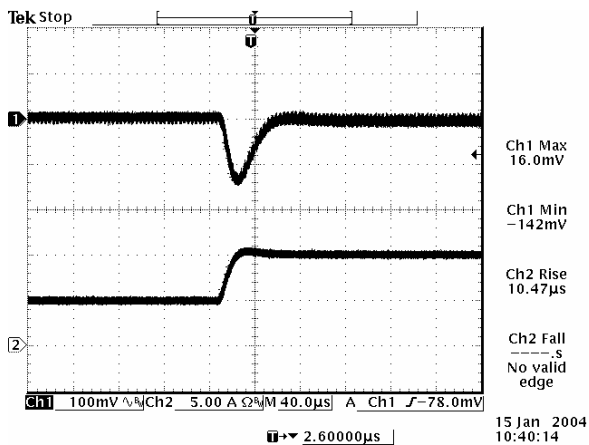

Transients 50% to 100% load 1.8 Vdc output

Transients 100% to 50% load 1.8 Vdc output

NON-ISOLATED DC/DC CONVERTERS

8.3 Vdc - 14 Vdc Input

0.75 Vdc - 5.0 Vdc/10 A Output



Transient Response Waveforms (continued)

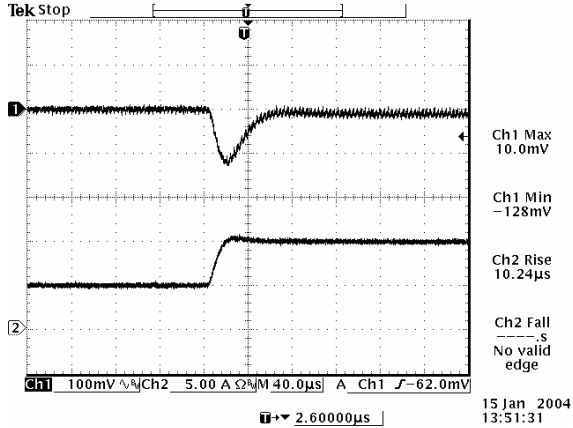

Transients 50% to 100% load 2.5 Vdc output

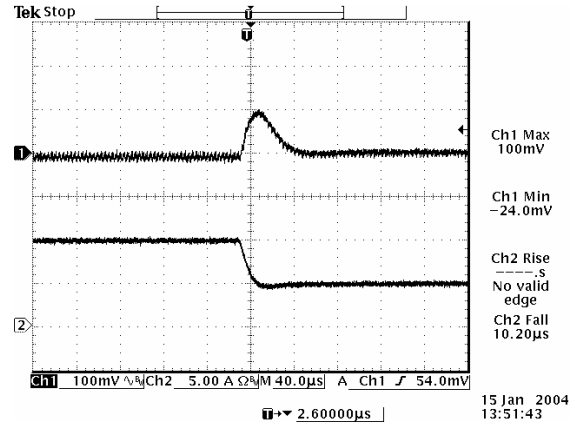

Transients 100% to 50% load 2.5 Vdc output

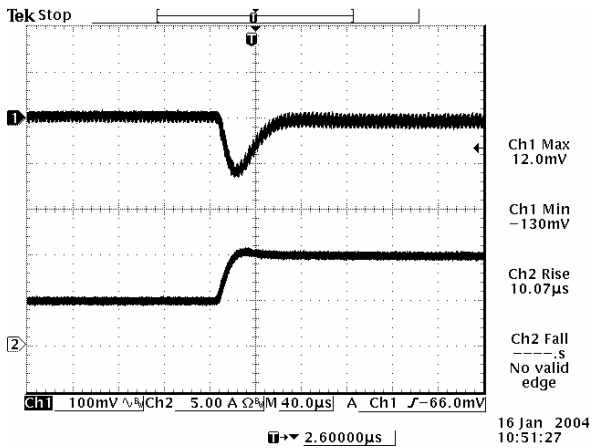

Transients 50% to 100% load 3.3 Vdc output

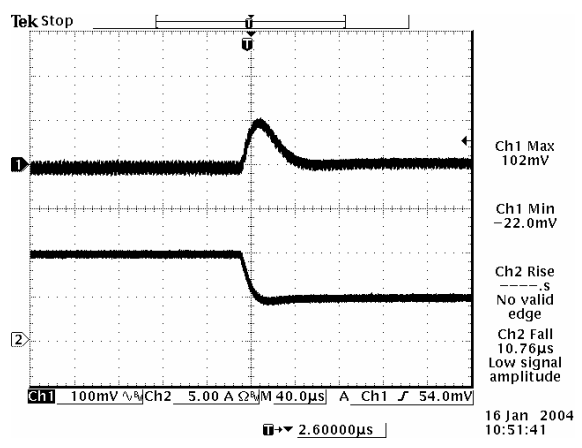

Transients 100% to 50% load 3.3 Vdc output

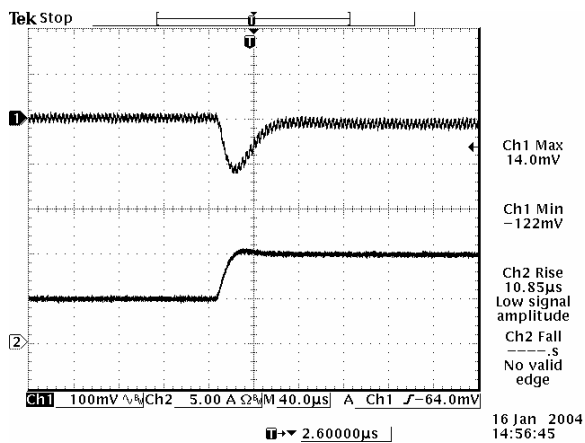

Transients 50% to 100% load 5.0 Vdc output

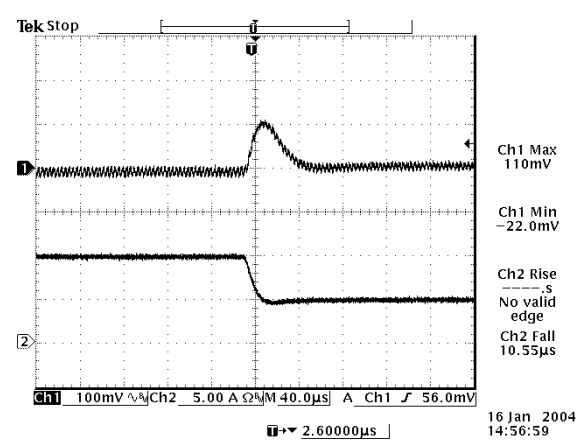

Transients 100% to 50% load 5.0 Vdc output

Note: Transient response at 12 V input, $di/dt=2.5 A/\mu S$, with external 2 x 150 μF polymer capacitor at the output, $T_a=25$ deg C.

NON-ISOLATED DC/DC CONVERTERS

8.3 Vdc - 14 Vdc Input

0.75 Vdc - 5.0 Vdc/10 A Output



Mechanical Outline

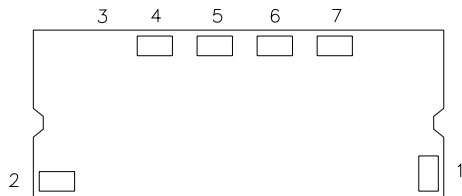
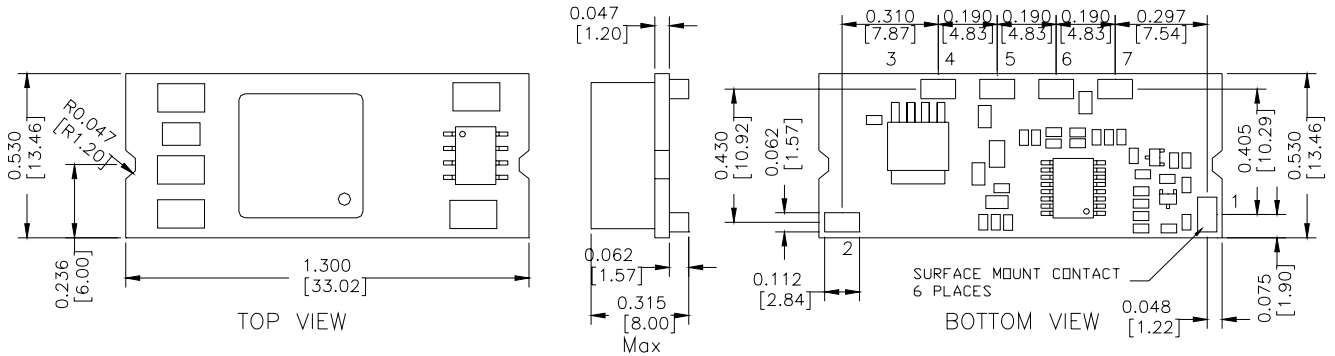

BOTTOM VIEW

RECOMMENDED PAD LAYOUT

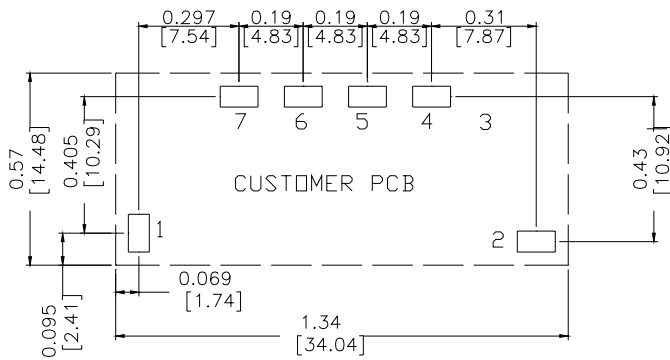

Pin Connections

Pin	Function
1	Remote On/Off
2	Vin+
3	N/A
4	Ground
5	Vout+
6	Trim
7	Remote Sense

PAD SIZE:

MIN: 0.14" * 0.095" (3.56mm * 2.41mm)

MAX: 0.165" * 0.11" (4.19mm * 2.79mm)

RoHS Compliance

Complies with the European Directive 2002/95/EC, calling for the elimination of lead and other hazardous substances from electronic products.



©2007 Bel Fuse Inc. Specifications subject to change without notice. 011707

CORPORATE

Bel Fuse Inc.
206 Van Vorst Street
Jersey City, NJ 07302
Tel 201-432-0463
Fax 201-432-9542
www.belfuse.com

FAR EAST

Bel Fuse Ltd.
8F/ 8 Luk Hop Street
San Po Kong
Kowloon, Hong Kong
Tel 852-2328-5515
Fax 852-2352-3706
www.belfuse.com

EUROPE

Bel Fuse Europe Ltd.
Preston Technology Management Centre
Marsh Lane, Suite G7, Preston
Lancashire, PR1 8UD, U.K.
Tel 44-1772-556601
Fax 44-1772-888366
www.belfuse.com