

NON-ISOLATED DC/DC CONVERTERS

2.4 Vdc - 5.5 Vdc Input

0.75 Vdc - 3.63 Vdc/10 A Output

bel
POWER PRODUCTS

SRBC-10F1Ax

RoHS Compliant

Rev.A

- Non-Isolated
- High Efficiency
- High Power Density
- Fixed Frequency (300 kHz)
- Remote On/Off
- Converter Can Sink and Source Current
- Under-voltage Lockout (UVLO)
- Over Temperature Protection
- OCP/SCP
- Wide Input
- Wide Trim
- Remote Sense
- Active Low/High (Option)



Description

The Bel SRBC-10F1Ax modules are a series of non-isolated dc/dc converters that deliver up to 10 A of output current with full load efficiency of 95% at 3.3 Vdc output. These modules provide precisely regulated voltage programmable via external resistor from 0.75 Vdc to 3.63 Vdc over a wide range of input voltage. The open-frame construction and small footprint enable designers to develop cost and space-efficient solutions. Standard features include remote On/Off, over current protection, short current protection, wide input, and programmable output voltage.

Part Selection

Output Voltage	Input Voltage	Max. Output Current	Max. Output Power	Typical Efficiency	Model Number Active Low	Model Number Active High
0.75 V - 3.63 V ¹	2.4 V - 5.5 V	10 A	36 W	95%	SRBC-10F1AL	SRBC-10F1A0

- Notes:**
1. These modules use a buck topology, so the output voltages must be 0.5 V less than the input voltage.
 2. Add "G" to the end of the Model Number to indicate Tray Packaging.
 3. All part numbers above indicate RoHS 6. Change the second letter "R" to "7" for RoHS 5 part numbers.

Absolute Maximum Ratings

Parameter	Min	Typ	Max	Notes
Input Voltage (continuous)	-0.3 V	-	5.8 V	
Output Enable Terminal Voltage	-0.3 V	-	5.8 V	
Ambient Temperature	-40 °C	-	85 °C	
Storage Temperature	-55 °C	-	125 °C	

Note: All specifications are typical at 25 °C unless otherwise stated.

NON-ISOLATED DC/DC CONVERTERS

2.4 Vdc - 5.5 Vdc Input

0.75 Vdc - 3.63 Vdc/10 A Output



Input Specifications

Parameter	Min	Typ	Max	Notes
Input Voltage	2.4 V	-	5.5 V	$V_o, \text{set} \leq V_{in} - 0.5 \text{ V}$
Input Current (full load)				
$V_o = 3.3 \text{ V}$	-	7.0 A	8.0 A	
$V_o = 2.5 \text{ V}$	-	5.5 A	9.5 A	
$V_o = 1.8 \text{ V}$	-	4.0 A	9.0 A	
$V_o = 1.5 \text{ V}$	-	3.5 A	7.5 A	
$V_o = 1.2 \text{ V}$	-	3.0 A	6.0 A	
$V_o = 0.75 \text{ V}$	-	2.0 A	4.0 A	
Input Current (no load)	-	80 mA	-	
Remote Off Input Current	-	15 mA	-	
Input Reflected Ripple Current (pk-pk)	-	140 mA	-	With simulated source impedance of 1 μH , 5 Hz to 20 MHz and two 100 μF /10 V external input Tantalum capacitors at the input.
Input Reflected Ripple Current (rms)	-	40 mA	-	
I^2t Inrush Current Transient	-	-	0.2 A^2s	
Turn-on Voltage Threshold	-	2.2 V	-	
Turn-off Voltage Threshold	-	2.0 V	-	

Note: All specifications are typical at 25 °C unless otherwise stated.

Output Specifications

Parameter	Min	Typ	Max	Notes
Output Voltage Set Point	-2% $V_{o,\text{set}}$	-	2% $V_{o,\text{set}}$	$V_{in} = 5 \text{ V}$, $I_o = I_o \text{ max}$
Output Voltage Set Point	-3% $V_{o,\text{set}}$	-	3% $V_{o,\text{set}}$	Over all operating input voltage, resistive load, and temperature conditions
Load Regulation	-	0.4% $V_{o,\text{set}}$	-	$I_o = I_{o\text{min}}$ to $I_{o\text{max}}$
Line Regulation	-	0.3% $V_{o,\text{set}}$	-	$V_{in} = V_{in\text{min}}$ to $V_{in\text{max}}$
Regulation Over Temperature (-40 °C to +85 °C)	-	0.5% $V_{o,\text{set}}$	-	
Output Current	0 A	-	10 A	
Current Limit Threshold	15 A	-	27 A	
Short Circuit Surge Transient	-	-	1.5 A^2s	
Ripple and Noise (pk-pk)	-	25 mV	50 mV	Tested with 0-20MHz, with external 10 μF /16V tantalum capacitor & 1 μF /10V TDK ceramic capacitor
Ripple and Noise (rms)	-	8 mV	15 mV	
Turn on Time	-	4 mS	8 mS	
Overshoot at Turn on	-	0%	3%	
Output Capacitance				
ESR $\geq 1 \text{ mohm}$	0 μF	-	1000 μF	
ESR $\geq 10 \text{ mohm}$	0 μF	-	4700 μF	

NON-ISOLATED DC/DC CONVERTERS

2.4 Vdc - 5.5 Vdc Input 0.75 Vdc - 3.63 Vdc/10 A Output



Output Specifications (continued)

Parameter	Min	Typ	Max	Notes
Transient Response				
50% ~ 100% Max Load	-	130 mV	-	di/dt=2.5 A/uS; Vin=5 V; and with external 2 × 150 uF/16 V Tantalum capacitors and 1 uF /10 V ceramic capacitor at the output
Settling Time	-	50 uS	-	
100% ~ 50% Max Load	-	150 mV	-	
Settling Time	-	50 uS	-	
50% ~ 100% Max Load	-	130 mV	-	
Settling Time	-	50 uS	-	
100% ~ 50% Max Load	-	130 mV	-	
Settling Time	-	50 uS	-	
50% ~ 100% Max Load	-	120 mV	-	
Settling Time	-	50 uS	-	
100% ~ 50% Max Load	-	120 mV	-	
Settling Time	-	50 uS	-	
50% ~ 100% Max Load	-	120 mV	-	
Settling Time	-	50 uS	-	
100% ~ 50% Max Load	-	120 mV	-	
Settling Time	-	50 uS	-	
50% ~ 100% Max Load	-	130 mV	-	
Settling Time	-	50 uS	-	
100% ~ 50% Max Load	-	130 mV	-	
Settling Time	-	50 uS	-	
50% ~ 100% Max Load	-	120 mV	-	
Settling Time	-	50 uS	-	
100% ~ 50% Max Load	-	140 mV	-	
Settling Time	-	50 uS	-	

Note: All specifications are typical at nominal input, full load at 25 °C unless otherwise stated.

General Specifications

Parameter	Min	Typ	Max	Notes
Efficiency				Measured at Vin=5 V, full load
Vo=3.3 V	92%	95%	-	
Vo=2.5 V	90%	93%	-	
Vo=1.8 V	88%	91%	-	
Vo=1.5 V	87%	90%	-	
Vo=1.2 V	85%	88%	-	
Vo=0.75 V	79%	82%	-	
Switching Frequency	250 kHz	300 kHz	350 kHz	
Over Temperature Shutdown	-	125 °C	-	
Output Voltage Trim Range	0.7525 V	-	3.63 V	Total adjustment of trim, setpoint and remote sense combined should not exceed 3.63 V. Vo=0.7525 V when trim pin open
Remote Sense Compensation	-	10%	-	
MTBF	6,643,156 hours			Calculated Per Bell Core SR-332 (Io = 80% Io, max; Vo=1.8 V; Vin=5.0 V; Ta = 25 °C)
Dimensions				
Inches (L × W × H)	1.3 x 0.53 x 0.315			
Millimeters (L × W × H)	33.02 x 13.46 x 8.00			
Weight	-	6.6 g	-	

Note: All specifications are typical at 25 °C unless otherwise stated.

NON-ISOLATED DC/DC CONVERTERS

2.4 Vdc - 5.5 Vdc Input

0.75 Vdc - 3.63 Vdc/10 A Output

bel
POWER PRODUCTS

Control Specifications

Parameter	Min	Typ	Max	Notes
Remote On/Off				
Signal Low (Unit Off)	-0.3 V	-	0.3 V	SRBC-10F1A0; Remote On/Off pin open, Unit on.
Signal High (Unit On)	1.5 V	-	5.8 V	
Signal Low (Unit On)	-0.3 V	-	0.3 V	SRBC-10F1AL; Remote On/Off pin open, Unit on.
Signal High (Unit Off)	1.5 V	-	5.8 V	

Remote Enable Specifications

The SRBC-10F1AL modules feature an enable pin with negative logic. If not using the enable pin, leave the pin open (the module will be on). During logic_high, the module is turned off, during logic_low, the module is turned on. Its inner circuit impedance is shown as figure.

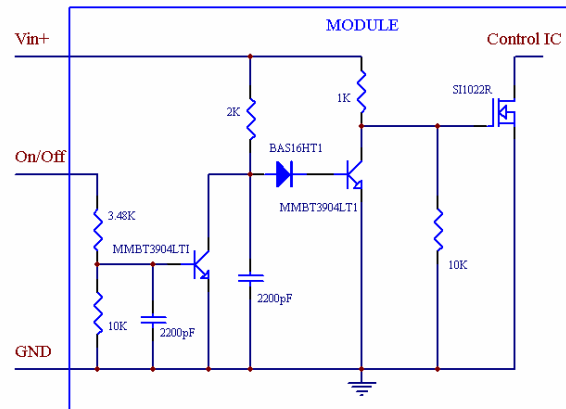

SRBC-10F1AL

The SRBC-10F1A0 modules feature an enable pin with Positive logic. If not using the enable pin, leave the pin open (the module will be on). During logic_high, the module is turned on, during logic_low, the module is turned off. Its inner circuit impedance is shown as figure.

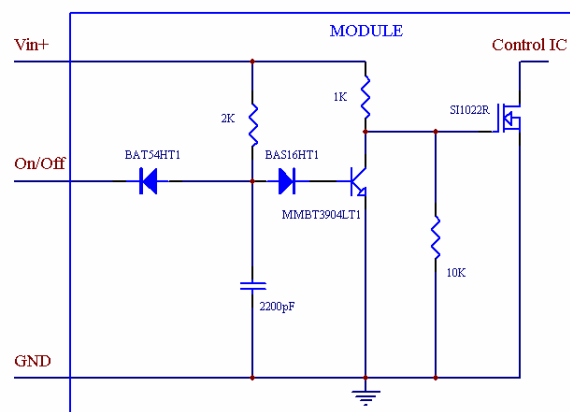

SRBC-10F1A0

NON-ISOLATED DC/DC CONVERTERS

2.4 Vdc - 5.5 Vdc Input

0.75 Vdc - 3.63 Vdc/10 A Output

bel
POWER PRODUCTS

Output Trim Equations

Equation for calculating the trim resistor (in K Ω) given the desired adjusted voltage (V_{adj}) is shown below. The Trim Up resistor should be connected between the Trim pin and Ground.

$$R_{trim} = \frac{21.07}{V_{adj} - 0.7525} - 5.11$$

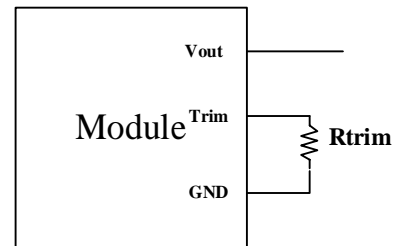

Equation for calculating the trim voltage (in V) given the desired adjusted voltage (V_{adj}) is shown below. The Trim Up voltage should be connected between the Trim pin and Ground.

$$V_{trim} = 0.7 - 0.1698 \times (V_{adj} - 0.7525)$$

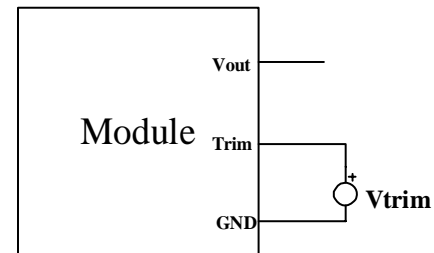

NON-ISOLATED DC/DC CONVERTERS

2.4 Vdc - 5.5 Vdc Input

0.75 Vdc - 3.63 Vdc/10 A Output



Efficiency Data

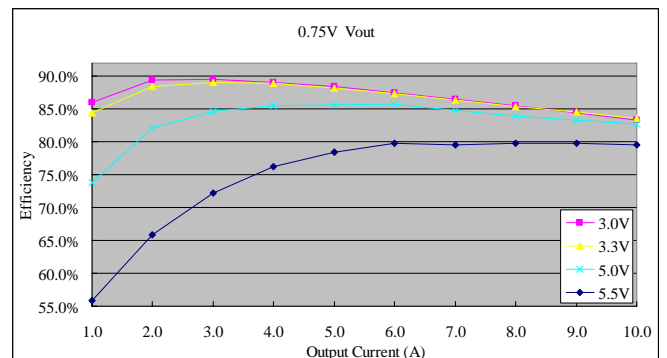
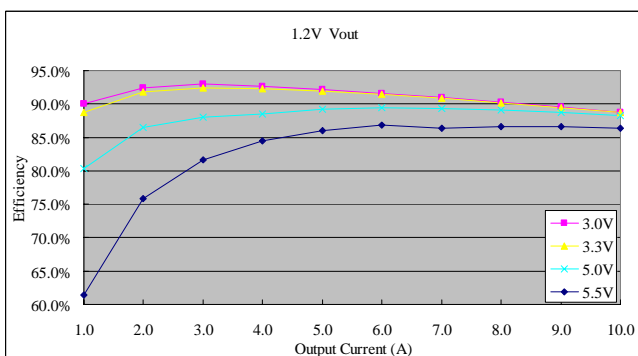
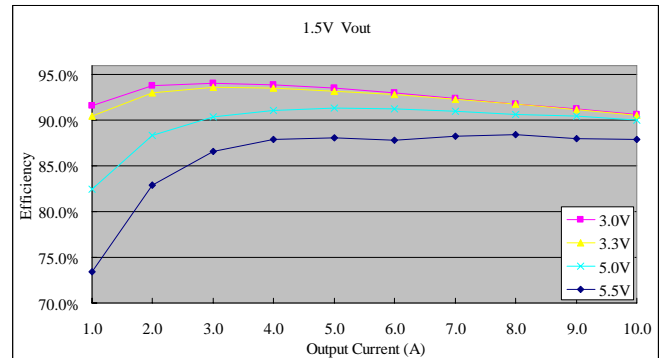
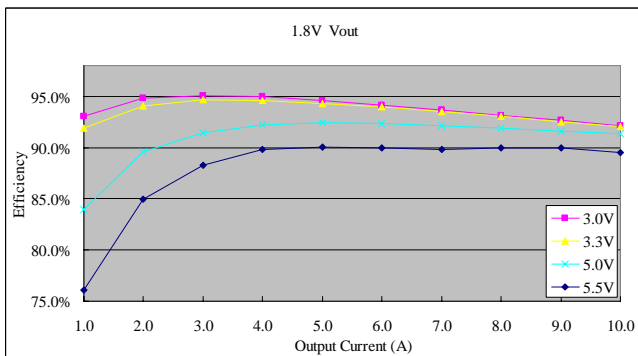
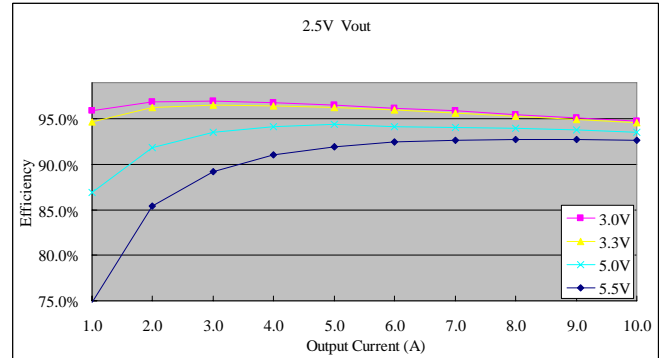
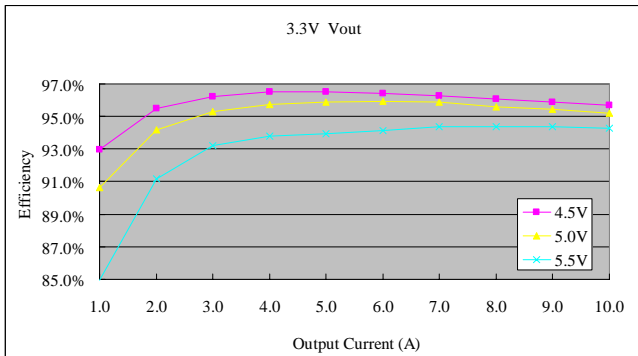

NON-ISOLATED DC/DC CONVERTERS

2.4 Vdc - 5.5 Vdc Input

0.75 Vdc - 3.63 Vdc/10 A Output



Thermal Derating Curves

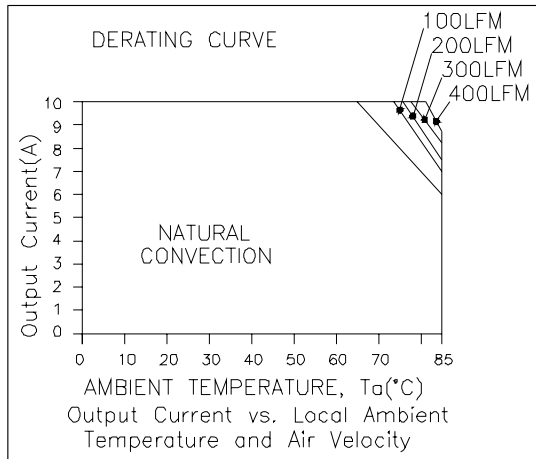

$V_{in}=5.0\text{ V}$, $V_o=0.75\text{ V}$

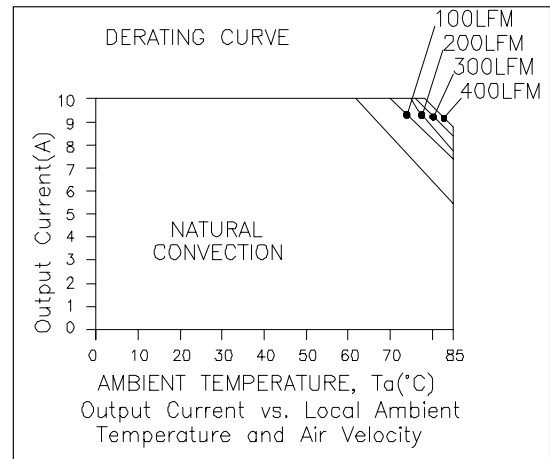

$V_{in}=5.0\text{ V}$, $V_o=1.5\text{ V}$

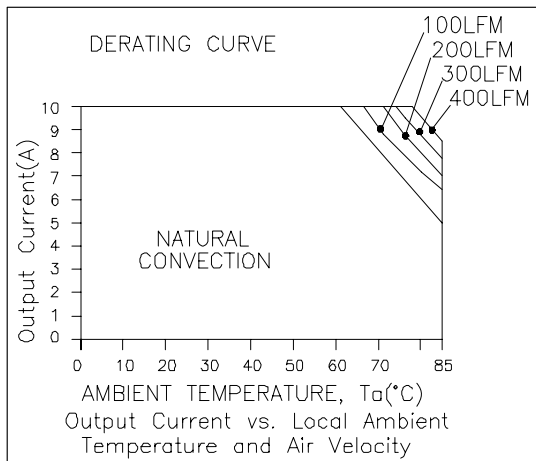

$V_{in}=5.0\text{ V}$, $V_o=2.5\text{ V}$

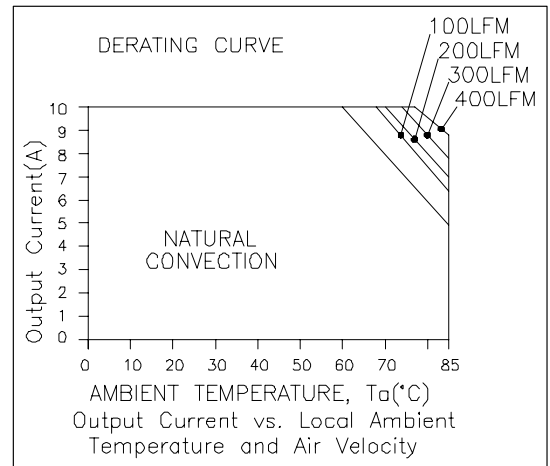

$V_{in}=5.0\text{ V}$, $V_o=3.3\text{ V}$

NON-ISOLATED DC/DC CONVERTERS

2.4 Vdc - 5.5 Vdc Input

0.75 Vdc - 3.63 Vdc/10 A Output



Thermal Derating Curves (continued)

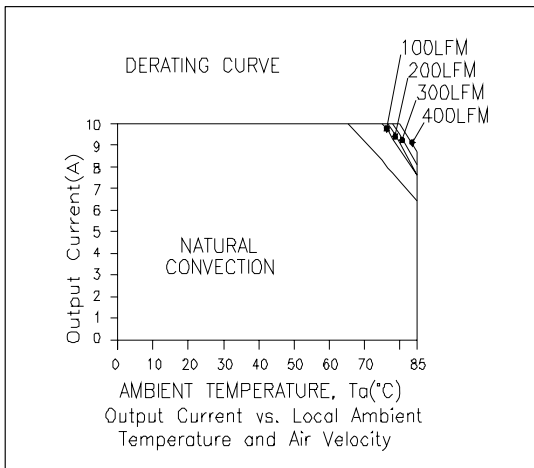

Vin=3.3 V, Vo=0.75 V

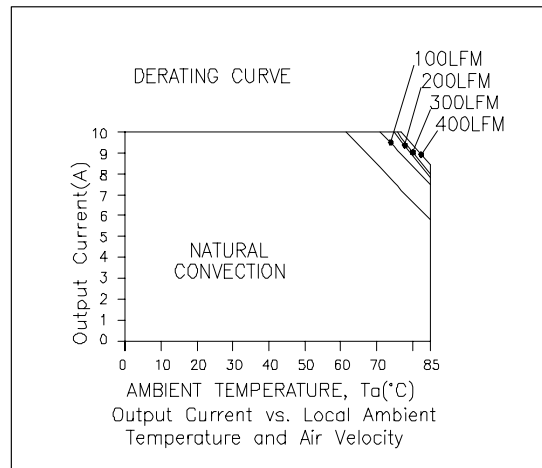

Vin=3.3 V, Vo=1.5 V

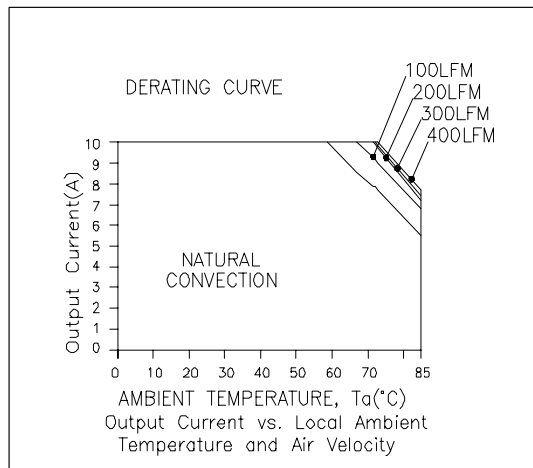

Vin=3.3 V, Vo=2.5 V

NON-ISOLATED DC/DC CONVERTERS

2.4 Vdc - 5.5 Vdc Input

0.75 Vdc - 3.63 Vdc/10 A Output



Ripple and Noise Waveforms

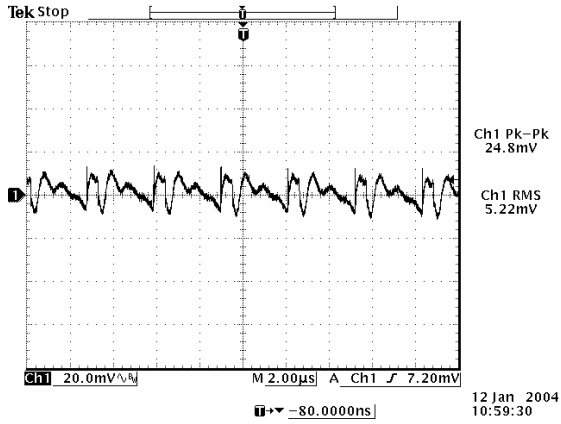

Vin=5.0 V, Vo=0.75 V

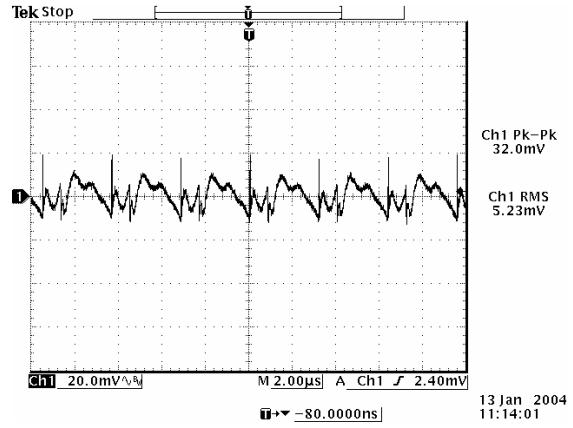

Vin=5.0 V, Vo=1.2 V

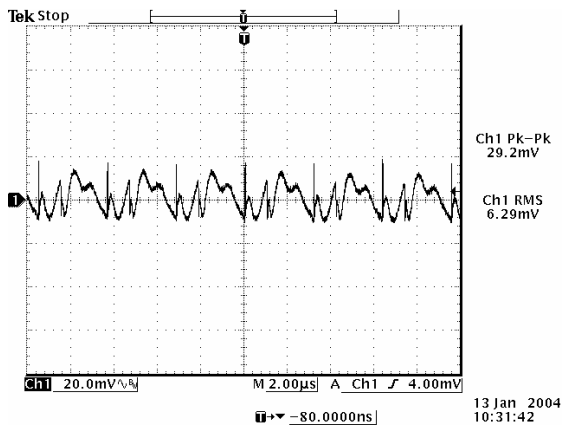

Vin=5.0 V, Vo=1.5 V

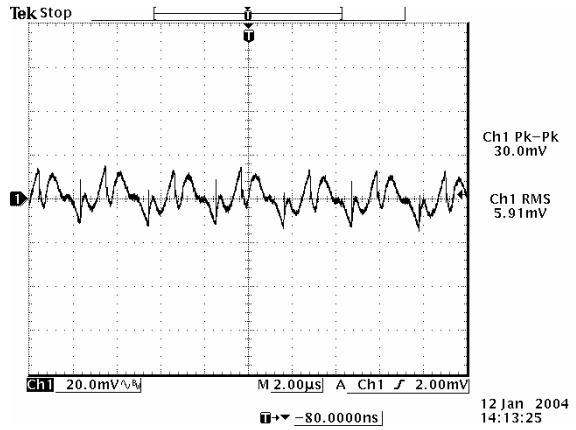

Vin=5.0 V, Vo=1.8 V

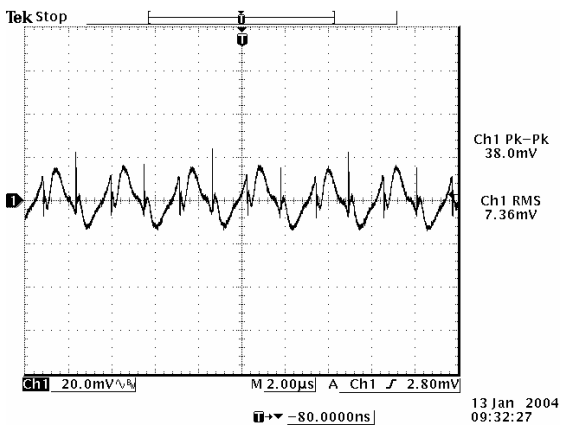

Vin=5.0 V, Vo=2.5 V

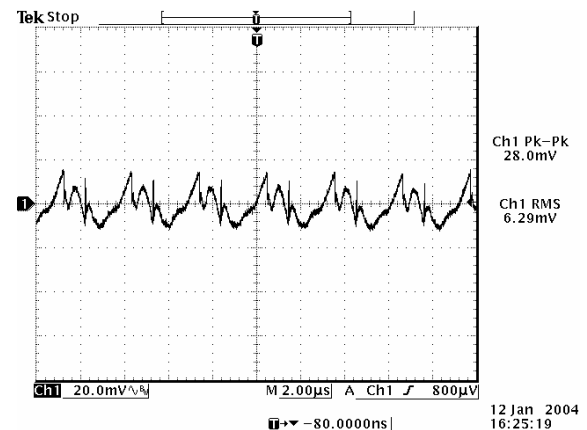

Vin=5.0 V, Vo=3.3 V

Note: Ripple and noise is tested at 0-20 MHz BW, 10 uF/16 V tantalum capacitor and 1 uF/10 V ceramic capacitor, full load, and Ta=25 deg C.

NON-ISOLATED DC/DC CONVERTERS

2.4 Vdc - 5.5 Vdc Input

0.75 Vdc - 3.63 Vdc/10 A Output



Transient Response Waveforms

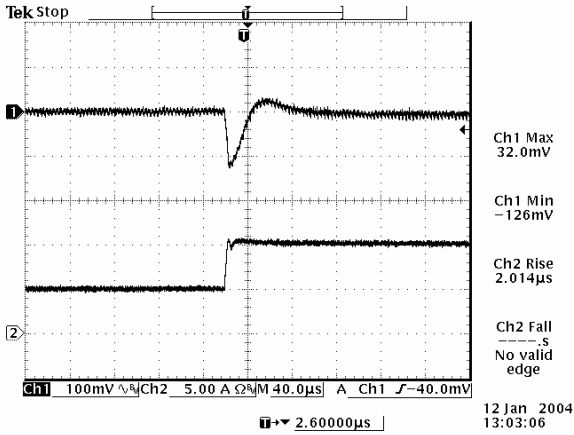

50% to 100% load step at $V_{in}=5\text{ V}$, $V_o=0.75\text{ V}$

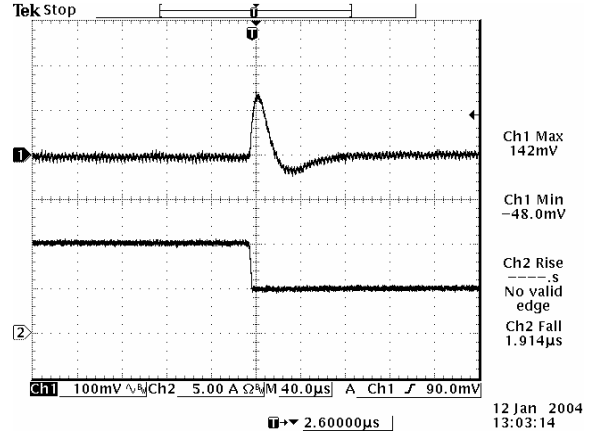

100% to 50% load step at $V_{in}=5\text{ V}$, $V_o=0.75\text{ V}$

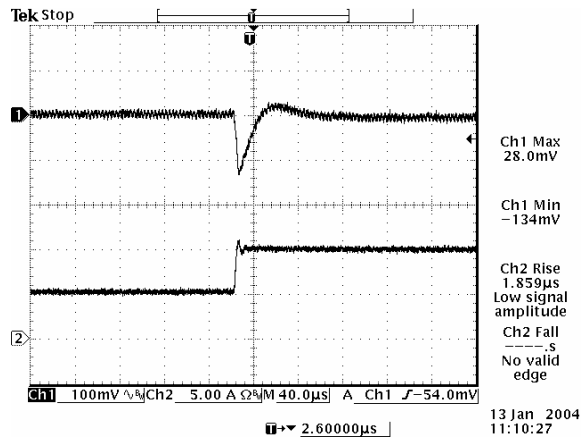

50% to 100% load step at $V_{in}=5\text{ V}$, $V_o=1.2\text{ V}$

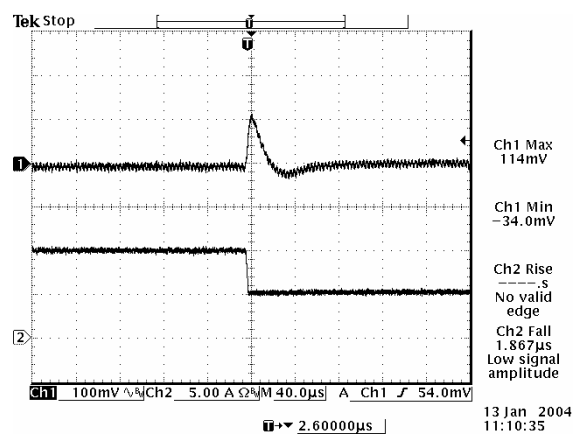

100% to 50% load step at $V_{in}=5\text{ V}$, $V_o=1.2\text{ V}$

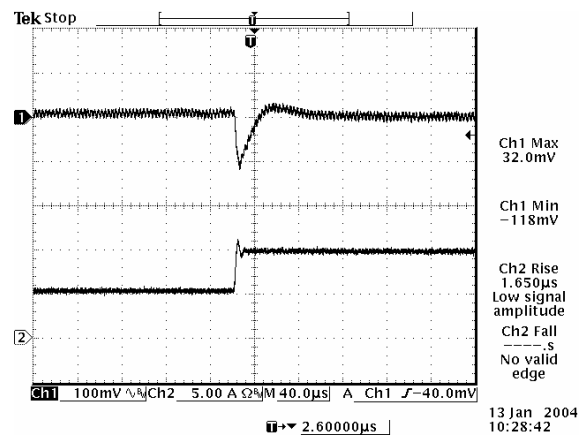

50% to 100% load step at $V_{in}=5\text{ V}$, $V_o=1.5\text{ V}$

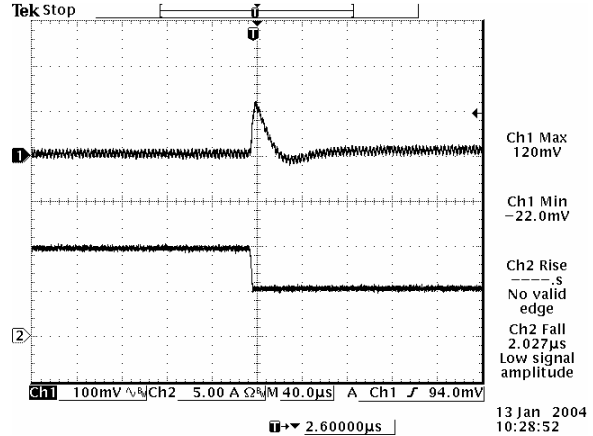

100% to 50% load step at $V_{in}=5\text{ V}$, $V_o=1.5\text{ V}$

NON-ISOLATED DC/DC CONVERTERS

2.4 Vdc - 5.5 Vdc Input

0.75 Vdc - 3.63 Vdc/10 A Output



Transient Response Waveforms (continued)

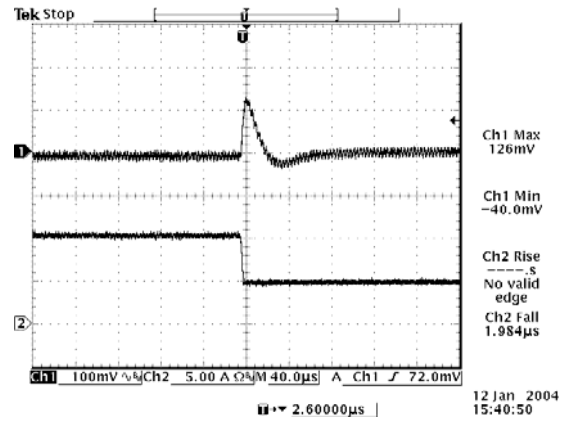
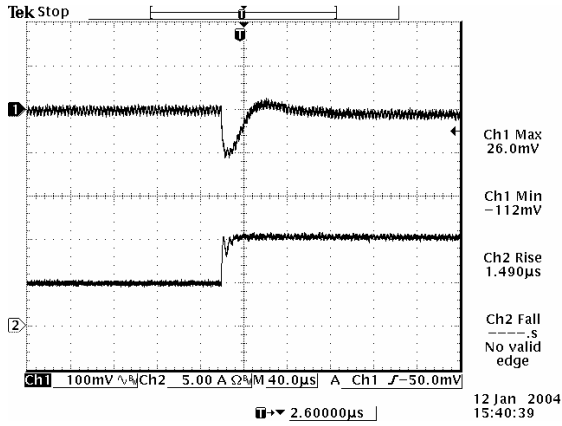

50% to 100% load step at $V_{in}=5\text{ V}$, $V_o=1.8\text{ V}$

100% to 50% load step at $V_{in}=5\text{ V}$, $V_o=1.8\text{ V}$

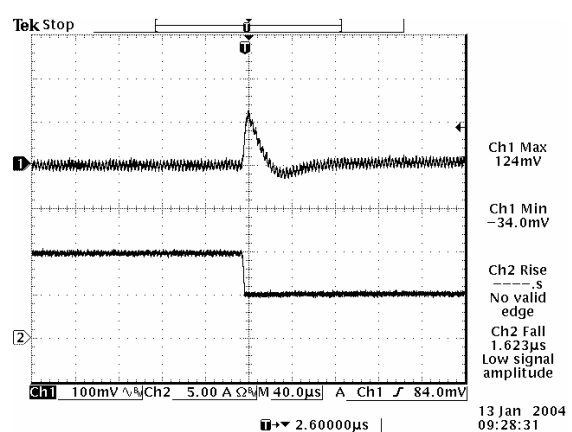
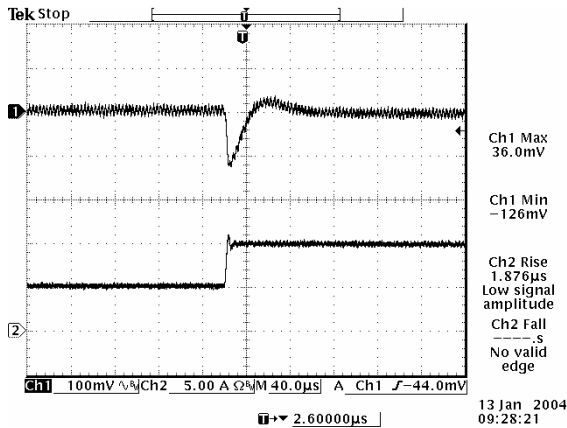

50% to 100% load step at $V_{in}=5\text{ V}$, $V_o=2.5\text{ V}$

100% to 50% load step at $V_{in}=5\text{ V}$, $V_o=2.5\text{ V}$

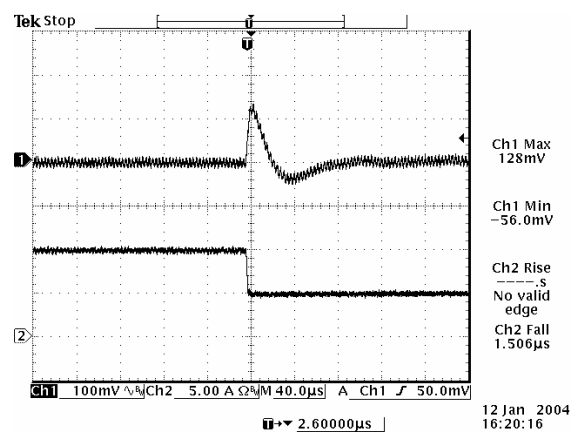
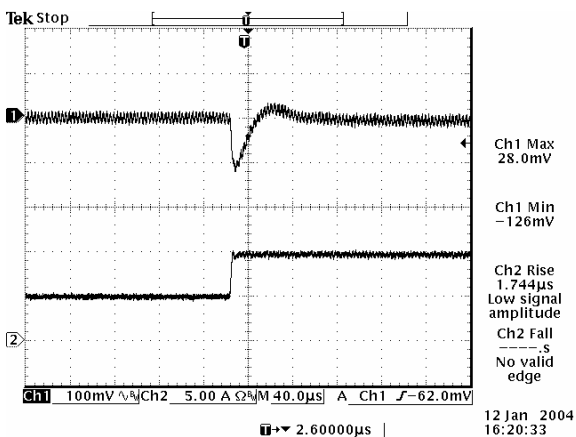

50% to 100% load step at $V_{in}=5\text{ V}$, $V_o=3.3\text{ V}$

100% to 50% load step at $V_{in}=5\text{ V}$, $V_o=3.3\text{ V}$

Note: Transient response is tested at $di/dt=2.5\text{ A}/\mu\text{s}$, with two $150\text{ }\mu\text{F}/16\text{ V}$ tantalum capacitors and $1\text{ }\mu\text{F}/10\text{ V}$ ceramic capacitor, $T_a=25\text{ deg C}$.

NON-ISOLATED DC/DC CONVERTERS

2.4 Vdc - 5.5 Vdc Input

0.75 Vdc - 3.63 Vdc/10 A Output



Mechanical Outline

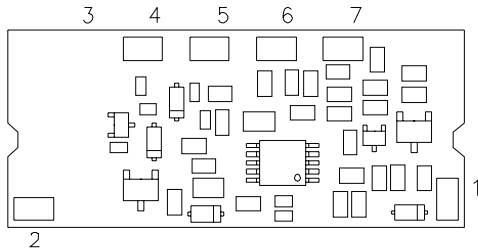
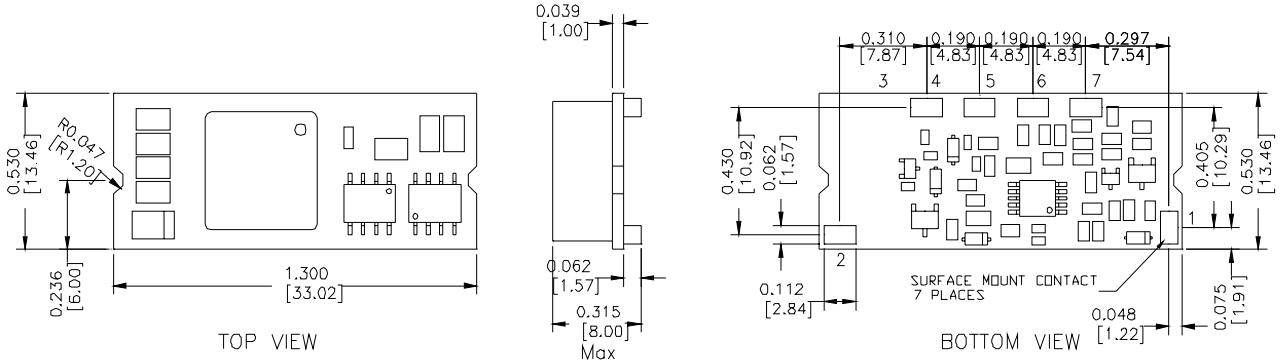

BOTTOM VIEW

RECOMMENDED PAD LAYOUT

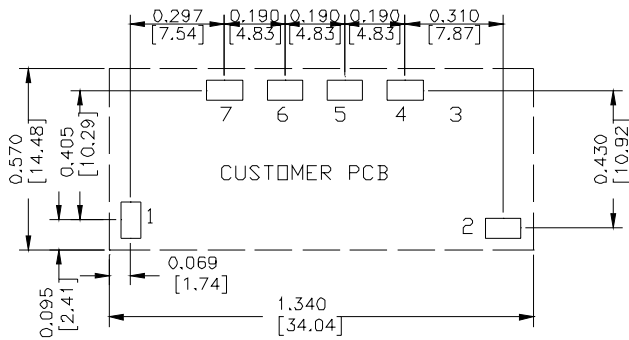

Pin Connections

Pin	Function
1	Remote On/Off
2	Vin
3	N/A
4	Ground
5	Vout
6	Trim
7	Remote Sense

PAD SIZE:

MIN: 0.14" * 0.095" (3.56mm * 2.41mm)

MAX: 0.165" * 0.11" (4.19mm * 2.79mm)

RoHS Compliance

Complies with the European Directive 2002/95/EC, calling for the elimination of lead and other hazardous substances from electronic products.



©2007 Bel Fuse Inc. Specifications subject to change without notice. 011807

CORPORATE

Bel Fuse Inc.
 206 Van Vorst Street
 Jersey City, NJ 07302
 Tel 201-432-0463
 Fax 201-432-9542
www.belfuse.com

FAR EAST

Bel Fuse Ltd.
 8F/ 8 Luk Hop Street
 San Po Kong
 Kowloon, Hong Kong
 Tel 852-2328-5515
 Fax 852-2352-3706
www.belfuse.com

EUROPE

Bel Fuse Europe Ltd.
 Preston Technology Management Centre
 Marsh Lane, Suite G7, Preston
 Lancashire, PR1 8UD, U.K.
 Tel 44-1772-556601
 Fax 44-1772-888366
www.belfuse.com