

## NON-ISOLATED DC/DC CONVERTERS

2.4 Vdc - 5.5 Vdc Input

0.75 Vdc - 3.63 Vdc/16 A Output

**bel**  
POWER PRODUCTS

SRBC-16F1Ax

RoHS Compliant

Rev.A

- Non-Isolated
- High Efficiency
- High Power Density
- Fixed Frequency (300 kHz)
- Remote On/Off
- Converter Can Sink and Source Current
- Under-voltage Lockout (UVLO)
- Over Temperature Protection
- OCP/SCP
- Wide Input
- Wide Trim Range
- Remote Sense
- Active High/Low (option)



### Description

The Bel SRBC-16F1Ax modules are a series of non-isolated dc/dc converters that deliver up to 16 A of output current with full load efficiency of 94% at 3.3 Vdc output. These modules provide precisely regulated voltage programmable via external resistor from 0.75 Vdc to 3.63 Vdc over a wide range of input voltage ( $V_{in}=2.4$  Vdc - 5.5 Vdc). The open-frame construction and small footprint enable designers to develop cost and space-efficient solutions. Standard features include remote On/Off, over current protection, short current protection, wide input, and programmable output voltage.

### Part Selection

Output Voltage	Input Voltage	Max. Output Current	Max. Output Power	Typical Efficiency	Model Number Active Low	Model Number Active High	Model Number Active Low
0.75 V-3.63 V <sup>1</sup>	2.4 V-5.5 V	16 A	58 W	94%	SRBC-16F1AL	SRBC-16F1A0	SRBC-16F1AW <sup>2</sup>

- Notes:**
1. These modules use a buck topology, so the output voltages must be 0.8 V less than the input voltage.
  2. "W" indicates special coating.
  3. Add "G" to the end of the Model Number to indicate Tray Packaging.
  4. All part numbers above indicate RoHS 6. Change the second letter "R" to "7" for RoHS 5 part numbers.

### Absolute Maximum Ratings

Parameter	Min	Typ	Max	Notes
Input Voltage (continuous)	-0.3 V	-	5.8 V	
Output Enable Terminal Voltage	-0.3 V	-	5.8 V	
Ambient Temperature	-40 °C	-	85 °C	
Storage Temperature	-55 °C	-	125 °C	

**Note:** All specifications are typical at 25 °C unless otherwise stated.

### Input Specifications

Parameter	Min	Typ	Max	Notes
Input Voltage	$V_o \leq 1.5$ V	2.4 V	-	5.5 V
	$V_o = 1.8 - 2.5$ V	3.0 V	-	5.5 V
	$V_o = 3.3$ V	4.5 V	-	5.5 V
Input Current (full load)	$V_o = 3.3$ V	-	11.23 A	15.10 A
	$V_o = 2.5$ V	-	8.70 A	14.81 A
	$V_o = 1.8$ V	-	6.40 A	13.64 A
	$V_o = 1.5$ V	-	5.45 A	11.76 A
	$V_o = 1.2$ V	-	4.52 A	9.64 A
	$V_o = 0.75$ V	-	3.05 A	6.69 A

## NON-ISOLATED DC/DC CONVERTERS

2.4 Vdc - 5.5 Vdc Input

0.75 Vdc - 3.63 Vdc/16 A Output



### Input Specifications (continued)

Parameter	Min	Typ	Max	Notes
Input Current (no load)	-	80 mA	-	
Remote Off Input Current	-	10 mA	22 mA	
Input Reflected Ripple Current (pk-pk)	-	100 mA	-	With simulated source impedance of 1 uH, 5 Hz to 20 MHz and two 100 uF /10 V external input Tantalum capacitors at the input.
Input Reflected Ripple Current (rms)	-	40 mA	-	
I <sup>2</sup> t Inrush Current Transient	-	0.15 A <sup>2</sup> s	0.3 A <sup>2</sup> s	
Turn-on Voltage Threshold	-	2.2 V	-	
Turn-off Voltage Threshold	-	2.0 V	-	

**Note:** All specifications are typical at 25 °C unless otherwise stated.

### Output Specifications

Parameter	Min	Typ	Max	Notes
Output Voltage Set Point	-2% Vo,set	-	2% Vo,set	Vin=5 V, Io=Io max
Output Voltage Set Point	-3% Vo,set	-	3% Vo,set	Over all operating input voltage, resistive load, and temperature conditions
Load Regulation	-	0.4% Vo,set	-	Io=Io min to Io max
Line Regulation	-	0.3% Vo,set	-	Vin=Vin min to Vin max
Regulation Over Temperature (-40 °C to +85 °C)	-	0.5% Vo,set	-	
Output Current	0 A	-	16 A	
Current Limit Threshold	19 A	-	35 A	
Short Circuit Surge Transient	-	1.6 A <sup>2</sup> s	2 A <sup>2</sup> s	
Ripple and Noise (pk-pk)	-	25 mV	50 mV	Tested with 0-20 MHz, with external 10 uF/16 V tantalum capacitor & 1 uF /10 V TDK ceramic capacitor
Ripple and Noise (rms)	-	8 mV	15 mV	
Turn on Time	-	4 mS	8 mS	
Overshoot at Turn on	-	0%	3%	
Output Capacitance				
ESR ≥1 mohm	0 uF	-	1000 uF	
ESR ≥10 mohm	0 uF	-	5000 uF	
<b>Transient Response</b>				
50% ~ 100% Max Load	Vo=0.75-3.3 V	-	300 mV	di/dt=2.5 A/uS; Vin=5 V; and with external 10 uF / 16 V Tantalum capacitors and 1 uF/10 V ceramic capacitor at the output
Settling Time		-	50 uS	
100% ~ 50% Max Load		-	300 mV	
Settling Time		-	50 uS	
50% ~ 100% Max Load	Vo=0.75-3.3 V	-	150 mV	di/dt=2.5 A/uS; Vin=5 V; and with external 2 x 150 uF / 10 V Tantalum capacitors and 1 uF/10 V ceramic capacitor at the output
Settling Time		-	100 uS	
100% ~ 50% Max Load		-	150 mV	
Settling Time		-	100 uS	

**Note:** All specifications are typical at nominal input, full load at 25 °C unless otherwise stated.

## NON-ISOLATED DC/DC CONVERTERS

2.4 Vdc - 5.5 Vdc Input

0.75 Vdc - 3.63 Vdc/16 A Output



### General Specifications

Parameter	Min	Typ	Max	Notes
Efficiency				
Vo=3.3 V	92%	94%	-	Measured at Vin=5 V, full load
Vo=2.5 V	90%	92%	-	
Vo=1.8 V	88%	90%	-	
Vo=1.5 V	85%	88%	-	
Vo=1.2 V	82%	85%	-	
Vo=0.7525 V	76%	79%	-	
Switching Frequency	250 kHz	300 kHz	350 kHz	
Over Temperature Shutdown	-	125 °C	-	
Output Voltage Trim Range	0.7525 V	-	3.63 V	Total adjustment of trim, setpoint and remote sense combined should not exceed 3.63 V. Vo=0.7525 V when trim pin open
Remote Sense Compensation	-	-	5%	
MTBF	5,438,000 hours			Calculated Per Bell Core SR-332 (Io = 80% Io, max; Vo=1.8 V; Vin=5.0 V; Ta = 25 °C)
Dimensions				
Inches (L x W x H)	1.3 x 0.53 x 0.315			
Millimeters (L x W x H)	33.02 x 13.46 x 8.00			
Weight	-	6.6 g	-	

**Note:** All specifications are typical at 25 °C unless otherwise stated.

### Control Specifications

Parameter	Min	Typ	Max	Notes
<b>Remote On/Off</b>				
Signal Low (Unit Off)	-0.3 V	-	0.3 V	SRBC-16F1A0; Remote On/Off pin open, Unit on.
Signal High (Unit On)	1.5 V	-	5.8 V	
Signal Low (Unit On)	-0.3 V	-	0.3 V	SRBC-16F1AL & SRBC-16F1AW; Remote On/Off pin open, Unit on.
Signal High (Unit Off)	1.5 V	-	5.8 V	

## NON-ISOLATED DC/DC CONVERTERS

2.4 Vdc - 5.5 Vdc Input

0.75 Vdc - 3.63 Vdc/16 A Output

**bel**  
POWER PRODUCTS

### Remote Enable Specifications

The SRBC-16F1AL modules feature an enable pin with negative logic. If not using the enable pin, leave the pin open (the module will be on). During logic\_high, the module is turned off, during logic\_low, the module is turned on. Its inner circuit impedance is shown as figure.

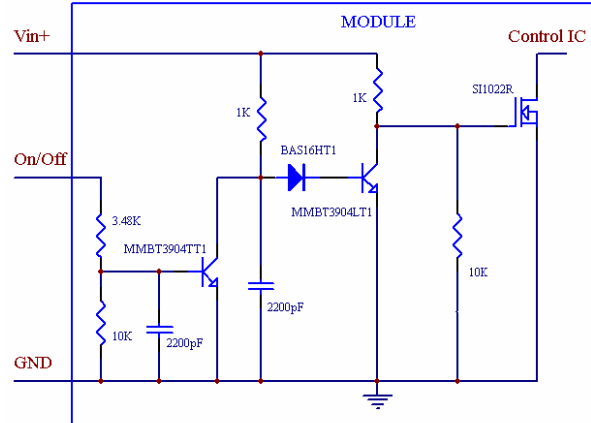

SRBC-16F1AL

The SRBC-16F1A0 modules feature an enable pin with Positive logic. If not using the enable pin, leave the pin open (the module will be on). During logic\_high, the module is turned on, during logic\_low, the module is turned off. Its inner circuit impedance is shown as figure.

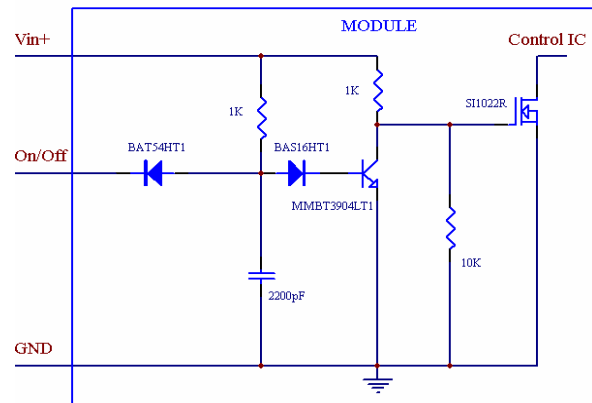

SRBC-16F1A0

### Output Trim Equations

Equation for calculating the trim resistor (in KΩ) given the desired adjusted voltage ( $V_{adj}$ ) is shown below. The Trim Up resistor should be connected between the Trim pin and Ground.

$$R_{trim} = \frac{21.07}{V_{adj} - 0.7525} - 5.11$$

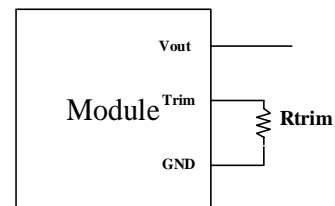

Equation for calculating the trim voltage (in V) given the desired adjusted voltage ( $V_{adj}$ ) is shown below. The Trim Up voltage should be connected between the Trim pin and Ground.

$$V_{trim} = 0.7 - 0.1698 \times (V_{adj} - 0.7525)$$

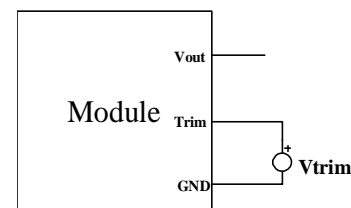

# NON-ISOLATED DC/DC CONVERTERS

2.4 Vdc - 5.5 Vdc Input

0.75 Vdc - 3.63 Vdc/16 A Output



## Efficiency Data

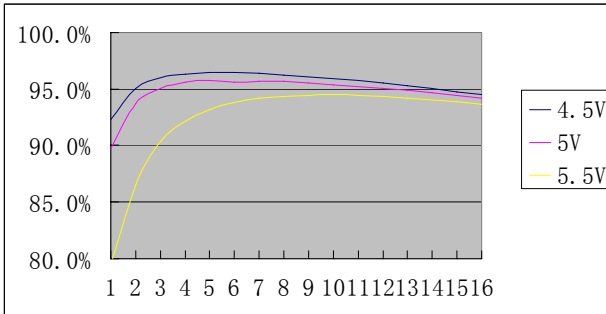

$V_o=3.3V$

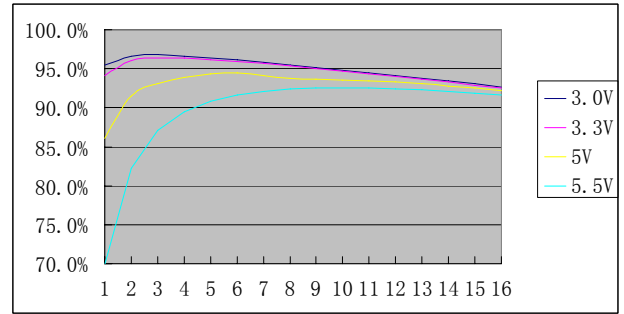

$V_o=2.5V$

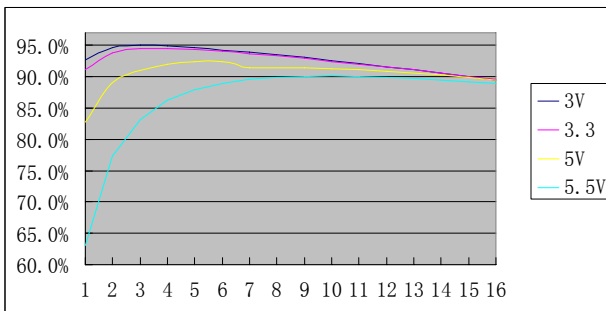

$V_o=1.8V$

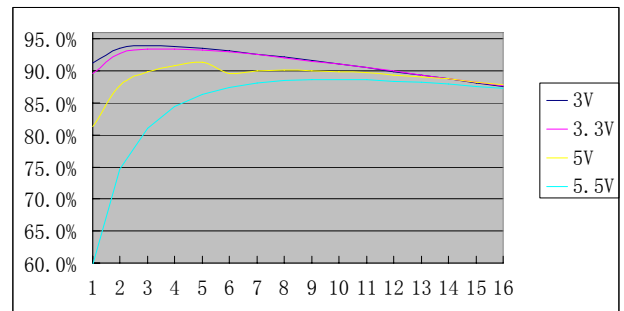

$V_o=1.5V$

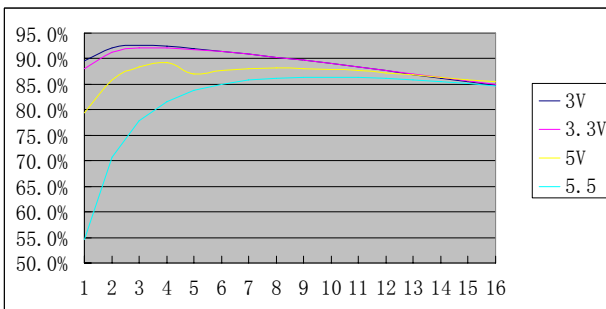

$V_o=1.2V$

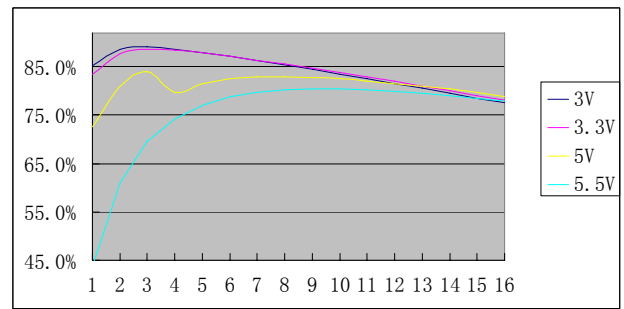

$V_o=0.75V$

# NON-ISOLATED DC/DC CONVERTERS

2.4 Vdc - 5.5 Vdc Input

0.75 Vdc - 3.63 Vdc/16 A Output



## Thermal Derating Curves

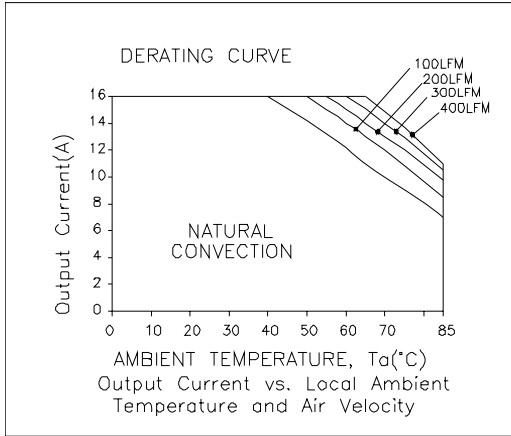

Vin=5.0 V, Vo=3.3 V or 2.5 V

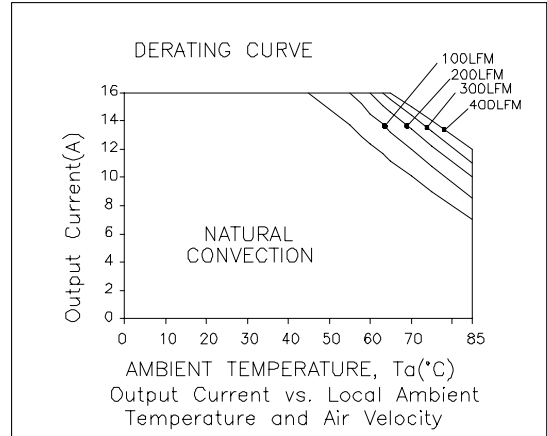

Vin=5.0 V, Vo=1.8 V or 1.5 V

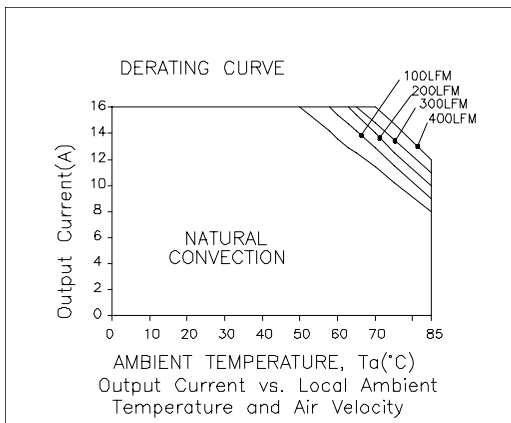

Vin=5.0 V, Vo=0.7525 V or 1.2 V

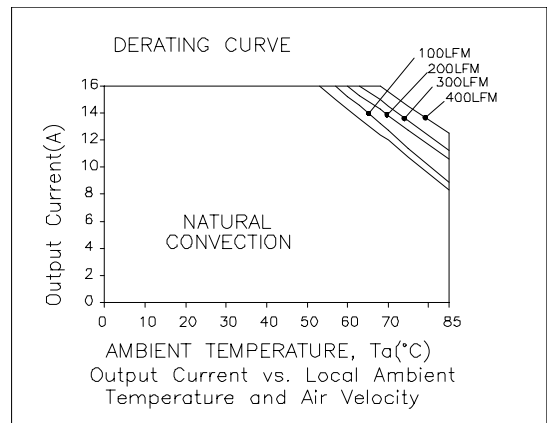

Vin=3.3 V, Vo=1.8 V or 1.5 V

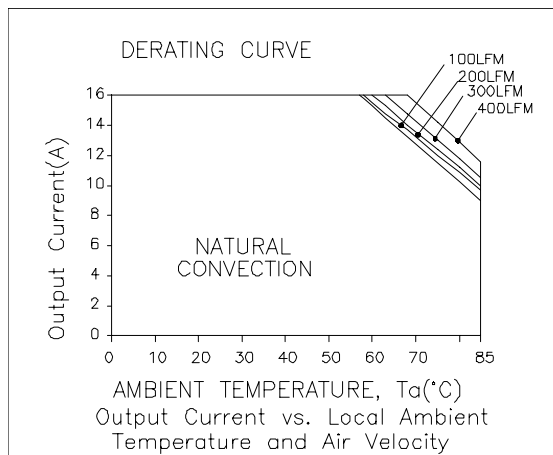

Vin=3.3 V, Vo=0.7525 V or 1.2 V

# NON-ISOLATED DC/DC CONVERTERS

2.4 Vdc - 5.5 Vdc Input

0.75 Vdc - 3.63 Vdc/16 A Output



## Ripple and Noise Waveforms

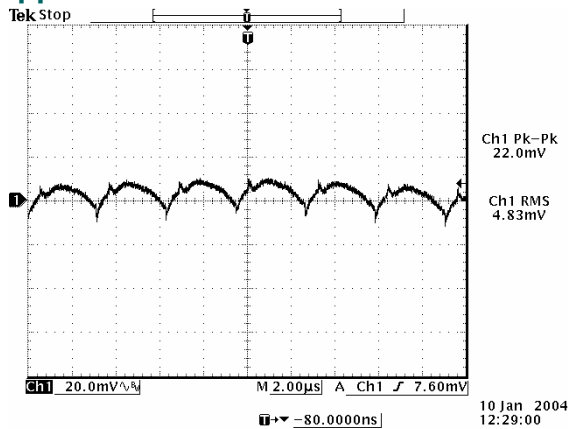

Vin=5.0 V, Vo=0.75 V

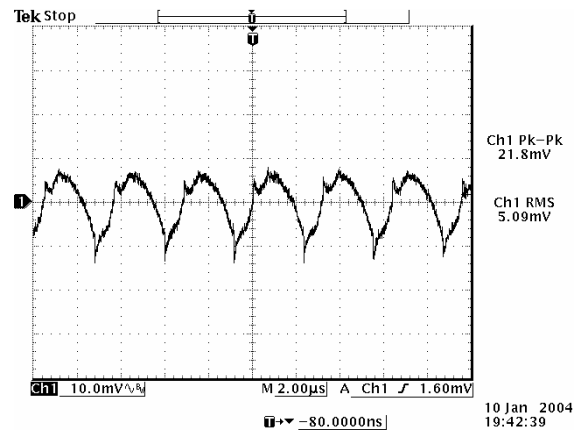

Vin=5.0 V, Vo=1.2 V

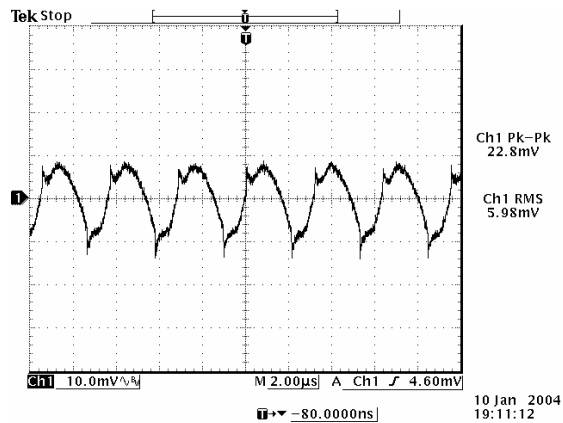

Vin=5.0 V, Vo=1.5 V

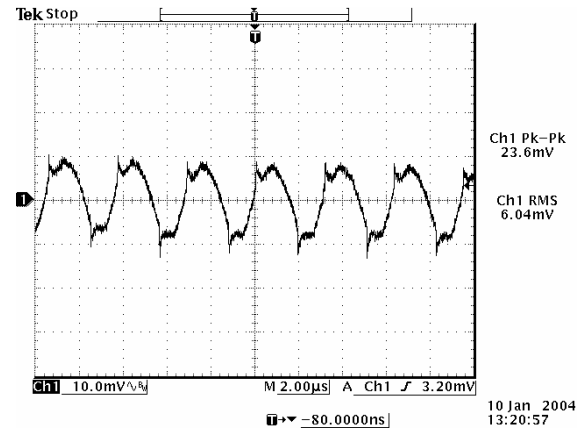

Vin=5.0 V, Vo=1.8 V

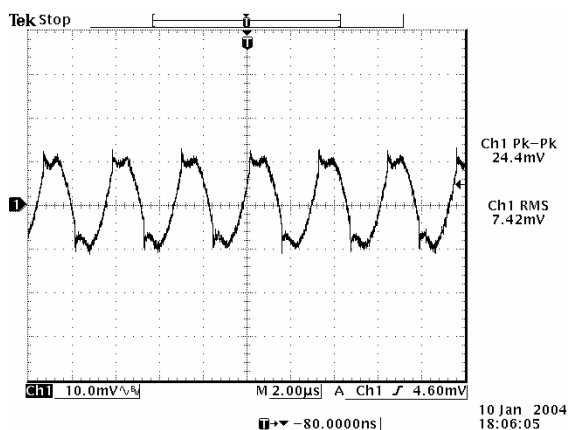

Vin=5.0 V, Vo=2.5 V

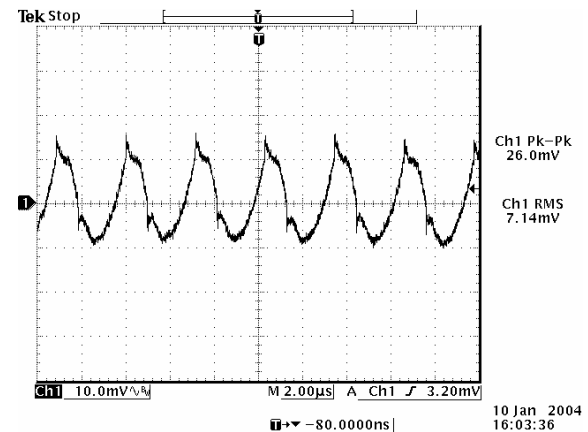

Vin=5.0 V, Vo=3.3 V

**Note:** Ripple and noise is tested at 0-20 MHz BW, 10  $\mu$ F/16 V tantalum capacitor and 1  $\mu$ F/10 V ceramic capacitor, full load, and  $T_a=25$  deg C.

# NON-ISOLATED DC/DC CONVERTERS

2.4 Vdc - 5.5 Vdc Input

0.75 Vdc - 3.63 Vdc/16 A Output



## Transient Response Waveforms

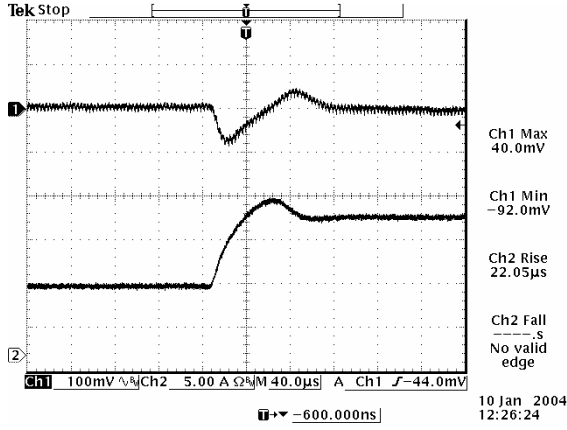

50% to 100% load step at  $V_{in}=5\text{ V}$ ,  $V_o=0.75\text{ V}$

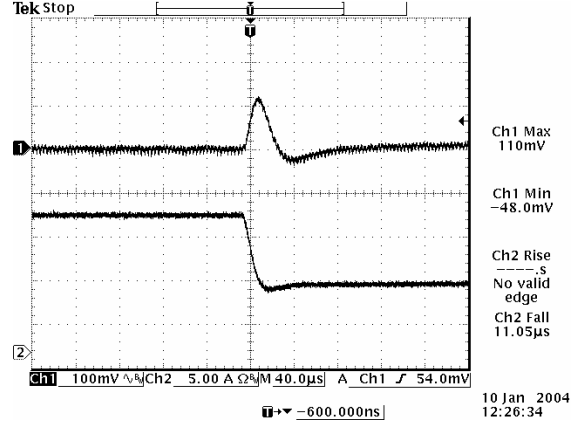

100% to 50% load step at  $V_{in}=5\text{ V}$ ,  $V_o=0.75\text{ V}$

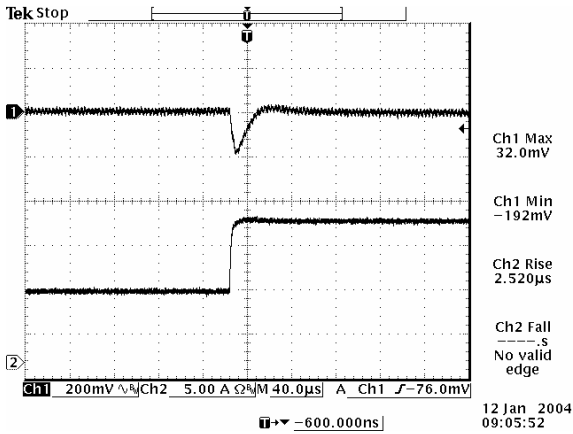

50% to 100% load step at  $V_{in}=5\text{ V}$ ,  $V_o=1.2\text{ V}$

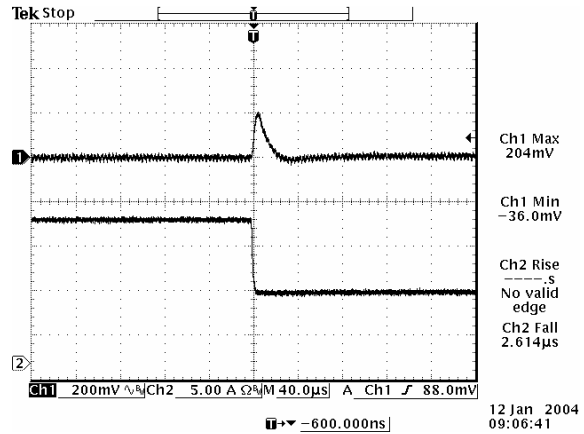

100% to 50% load step at  $V_{in}=5\text{ V}$ ,  $V_o=1.2\text{ V}$

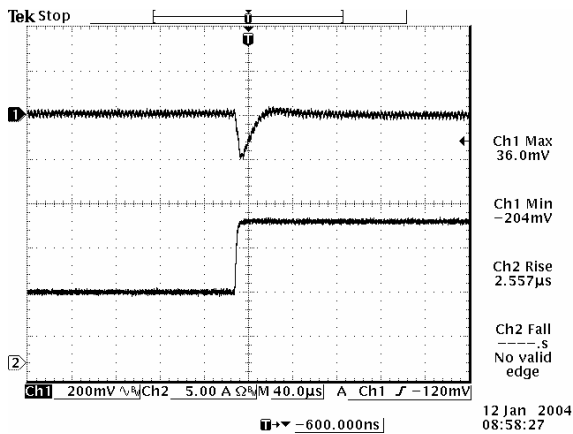

50% to 100% load step at  $V_{in}=5\text{ V}$ ,  $V_o=1.5\text{ V}$

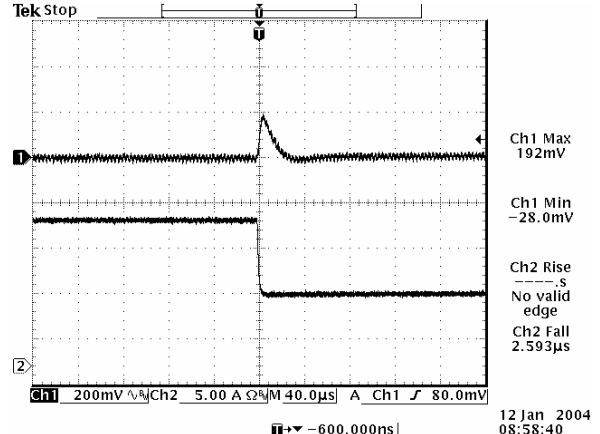

100% to 50% load step at  $V_{in}=5\text{ V}$ ,  $V_o=1.5\text{ V}$



# NON-ISOLATED DC/DC CONVERTERS

2.4 Vdc - 5.5 Vdc Input

0.75 Vdc - 3.63 Vdc/16 A Output



## Transient Response Waveforms (continued)

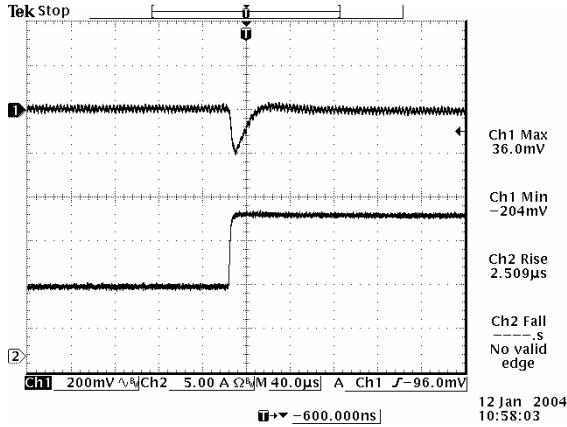

50% to 100% load step at  $V_{in}=5\text{ V}$ ,  $V_o=1.8\text{ V}$

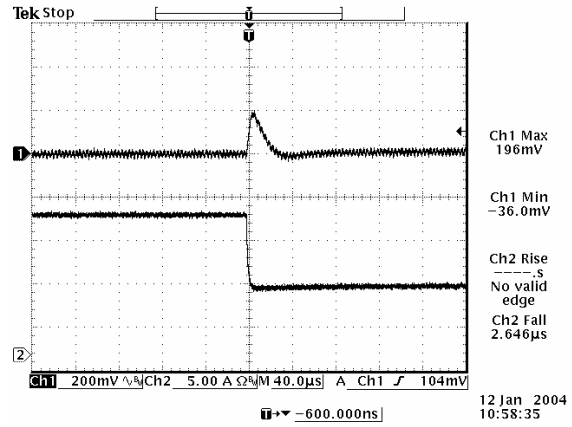

100% to 50% load step at  $V_{in}=5\text{ V}$ ,  $V_o=1.8\text{ V}$

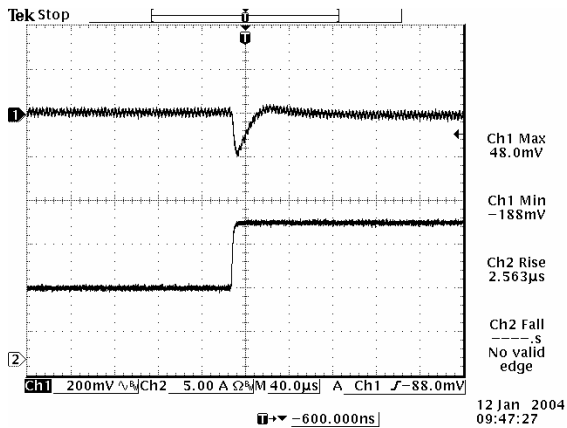

50% to 100% load step at  $V_{in}=5\text{ V}$ ,  $V_o=2.5\text{ V}$

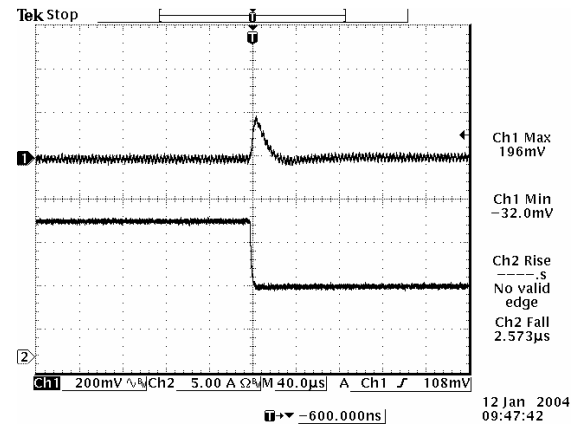

100% to 50% load step at  $V_{in}=5\text{ V}$ ,  $V_o=2.5\text{ V}$

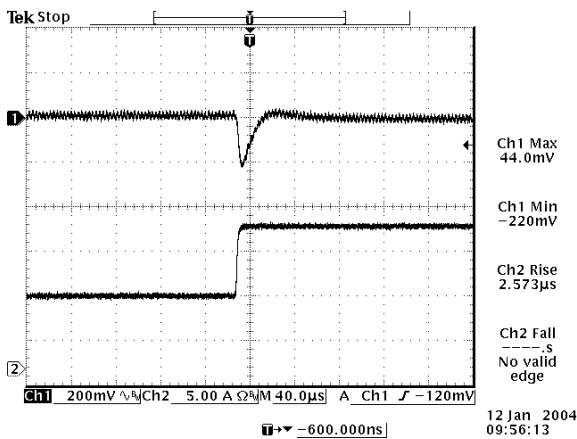

50% to 100% load step at  $V_{in}=5\text{ V}$ ,  $V_o=3.3\text{ V}$

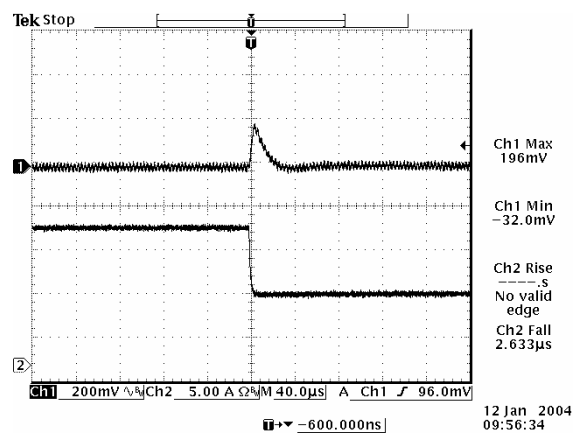

100% to 50% load step at  $V_{in}=5\text{ V}$ ,  $V_o=3.3\text{ V}$

**Note:** Transient response is tested at  $di/dt=2.5\text{ A}/\mu\text{S}$ , with two  $150\text{ }\mu\text{F}/10\text{ V}$  tantalum capacitors and  $1\text{ }\mu\text{F}/10\text{ V}$  ceramic capacitor,  $T_a=25\text{ deg C}$ .

# NON-ISOLATED DC/DC CONVERTERS

2.4 Vdc - 5.5 Vdc Input

0.75 Vdc - 3.63 Vdc/16 A Output



## Mechanical Outline

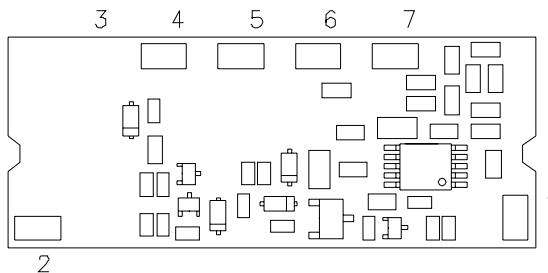
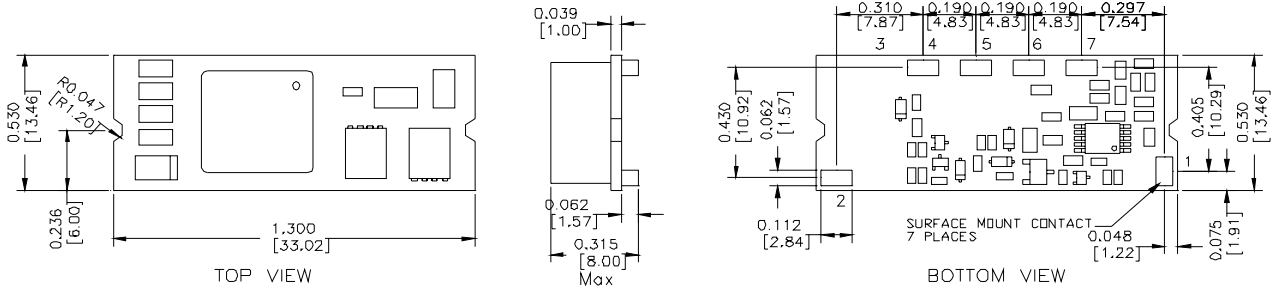

BOTTOM VIEW

## Pin Connections

Pin	Function
1	Remote On/Off
2	Vin
3	N/A
4	Ground
5	Vout
6	Trim
7	Remote Sense

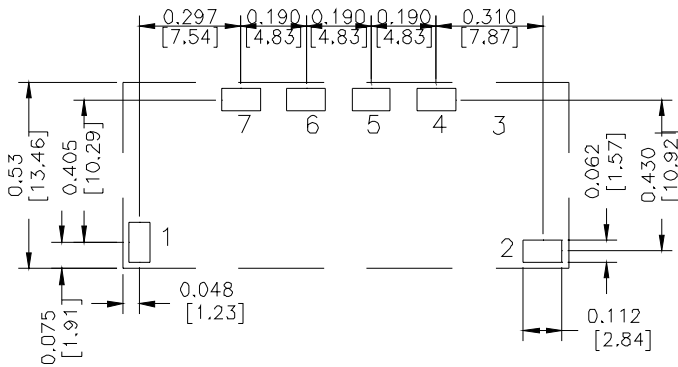

PAD SIZE:

MIN: 0.14" \* 0.095" (3.56mm \* 2.41mm)  
 MAX: 0.165" \* 0.11" (4.19mm \* 2.79mm)

## RoHS Compliance

Complies with the European Directive 2002/95/EC, calling for the elimination of lead and other hazardous substances from electronic products.



©2007 Bel Fuse Inc. Specifications subject to change without notice. 011607

### CORPORATE

**Bel Fuse Inc.**  
 206 Van Vorst Street  
 Jersey City, NJ 07302  
 Tel 201-432-0463  
 Fax 201-432-9542  
[www.belfuse.com](http://www.belfuse.com)

### FAR EAST

**Bel Fuse Ltd.**  
 8F/ 8 Luk Hop Street  
 San Po Kong  
 Kowloon, Hong Kong  
 Tel 852-2328-5515  
 Fax 852-2352-3706  
[www.belfuse.com](http://www.belfuse.com)

### EUROPE

**Bel Fuse Europe Ltd.**  
 Preston Technology Management Centre  
 Marsh Lane, Suite G7, Preston  
 Lancashire, PR1 8UD, U.K.  
 Tel 44-1772-556601  
 Fax 44-1772-888366  
[www.belfuse.com](http://www.belfuse.com)