

## NON-ISOLATED DC/DC CONVERTERS

8 Vdc - 14 Vdc Input 0.8 Vdc - 3.63 Vdc / 30 A Outputs

**bel**  
POWER PRODUCTS

### SRBG-30A1A0 RoHS Compliant PRELIMINARY Rev.A

- Non-Isolated
- Fixed Frequency
- High Efficiency
- Wide Trim
- Low Cost
- Remote Sense
- Input Under Voltage Lockout
- Over Temperature Shutdown
- Short Circuit Protection
- Remote On/Off
- Industrial Temperature Range



### Description

The Bel SRBG-30A1A0 is part of the non-isolated dc/dc converter Power Module series. The modules use a SMT package. These converters are available in a range of output voltages from 0.8 Vdc to 3.63 Vdc over a wide range of input voltage ( $V_{in} = 8 \text{ Vdc} - 14 \text{ Vdc}$ ). The efficiency is typically 92% at 12 Vdc input and 3.3 Vdc output at full load.

### Part Selection

Output Voltage	Input Voltage	Max. Output Current	Max. Output Power	Typical Efficiency	Model Number
0.8 Vdc - 3.3 Vdc	8 Vdc - 14 Vdc	30 A	99 W	92%	SRBG-30A1A0

**Notes:** 1. Add "G" or "R" suffix at the end of the model number to indicate Tray or Tape and Reel packaging.  
2. All part numbers above indicate RoHS 6. Change the second letter "R" to "7" for RoHS 5 part numbers.

### Absolute Maximum Ratings

Parameter	Min	Typ	Max	Notes
Input Voltage (continuous)	-0.3 V	-	15 V	
Output Enable Terminal Voltage	-0.3 V	-	15 V	
Ambient Temperature	-40 °C	-	85 °C	
Storage Temperature	-55 °C	-	125 °C	

### Input Specifications

Parameter	Min	Typ	Max	Notes
Input Voltage	8 V	12 V	14 V	
Input Current (full load)	-	-	15 A	
Input Current (no load)	-	270 mA	400 mA	
Remote Off Input Current	-	2 mA	-	
Input Reflected Ripple Current (pk-pk)	-	20 mA	50 mA	With a 1000 uF AL-Cap at the input.
Input Reflected Ripple Current (rms)	-	10 mA	30 mA	
I <sup>2</sup> t Inrush Current Transient	-	-	1 A <sup>2</sup> s	
Turn On Voltage Threshold	-	7.2 V	-	
Turn Off Voltage Threshold	-	6.9 V	-	

**Note:** All specifications are typical at nominal input, full load at 25 °C unless otherwise stated.

## NON-ISOLATED DC/DC CONVERTERS

8 Vdc - 14 Vdc Input 0.8 Vdc - 3.63 Vdc / 30 A Outputs



### Output Specifications

Parameter	Min	Typ	Max	Notes		
Output Voltage Set Point	-1.5%Vo, set	-	1.5%Vo, set	Vin=12 V, Io=half load		
Line Regulation	-	-	0.2%Vo, set			
Load Regulation	-	-	1.5%Vo, set			
Temperature Regulation (-40 °C to +85 °C)	-	-	1%Vo, set			
Ripple and Noise (rms)	-	20 mV	60 mV	0-20 MHz BW, with a 22 µF ceramic capacitor and a 150 µF tantalum capacitor at the output.		
Ripple and Noise (pk-pk)	-	60 mV	150 mV			
Output Current	0 A	-	30 A			
Short Circuit Surge Transient	-	1 A <sup>2</sup> s	3 A <sup>2</sup> s			
Turn on Time	-	4 mS	20 mS			
Overshoot at Turn On	-	-	5%			
Output Capacitance	150 µF	-	10000 µF			
<b>Transient Response</b>						
50% ~ 75% Max Load	Overshoot	Vo=3.3 V	-	90 mV	di/dt=0.5 A/us, Vin=12 Vdc, with a 22 µF ceramic capacitor and a 150 µF tantalum at the output.	
	Settling Time		-	25 µS		70 µS
75% ~ 50% Max Load	Overshoot		-	90 mV		180 mV
	Settling Time		-	25 µS		70 µS

**Note:** All specifications are typical at nominal input, full load at 25 °C unless otherwise stated.

### General Specifications

Parameter	Min	Typ	Max	Notes
Efficiency				Vin=12 V, full load
	Vo=0.8 V	77%	80%	
	Vo=3.3 V	89%	92%	-
Switching Frequency	-	600 kHz	-	
Output Voltage Trim Range	0.8 V	-	3.63 V	
Over Temperature Shutdown	-	130 °C	-	
Remote Sense Compensation	-	-	0.5 V	
MTBF	TBD			Calculated Per Bell Core SR-332 (Vin=12 V, Vo=3.3 V, Io =80%load; Ta = 25 °C)
Dimensions				
	Inches (L × W × H)	1.3 x 0.53 x 0.437		
	Millimeters (L × W × H)	33.02 x 13.46 x 11.10		
Weight	-	TBD	-	

**Note:** All specifications are typical at 25 °C unless otherwise stated.

# NON-ISOLATED DC/DC CONVERTERS

8 Vdc - 14 Vdc Input 0.8 Vdc - 3.63 Vdc / 30 A Outputs



## Control Specifications

Parameter	Min	Typ	Max	Notes
<b>Remote On/Off</b>				
Signal Low (Unit Off)	-0.3 V	-	0.8 V	Remote on/off pin open, unit on
Signal High (Unit On)	2.8 V	-	Vin, max	

## Remote Enable Specifications

The SRBG-30A1A0 modules feature an enable pin with Positive logic. If not using the enable pin, leave the pin open (the module will be on). During logic\_high, the module is turned on, during logic\_low, the module is turned off. Its inner circuit impedance is shown as the figure.

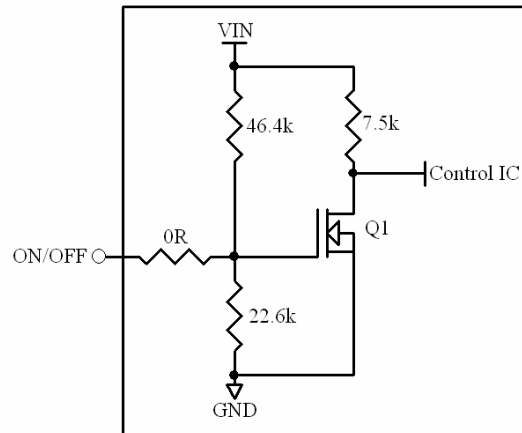

## Output Trim Equations

Equations for calculating the trim resistor are shown below (Unit: Ω). The Trim resistor should be connected between the Trim pin and Ground pin.

$$R_{trim} = \left[ \frac{9680}{V_o - 0.8} - 715 \right]$$

V<sub>o</sub> is the desired output voltage

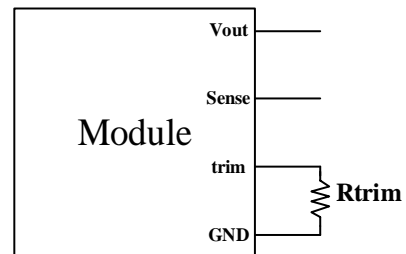

# NON-ISOLATED DC/DC CONVERTERS

8 Vdc - 14 Vdc Input 0.8 Vdc - 3.63 Vdc / 30 A Outputs



## Efficiency Data

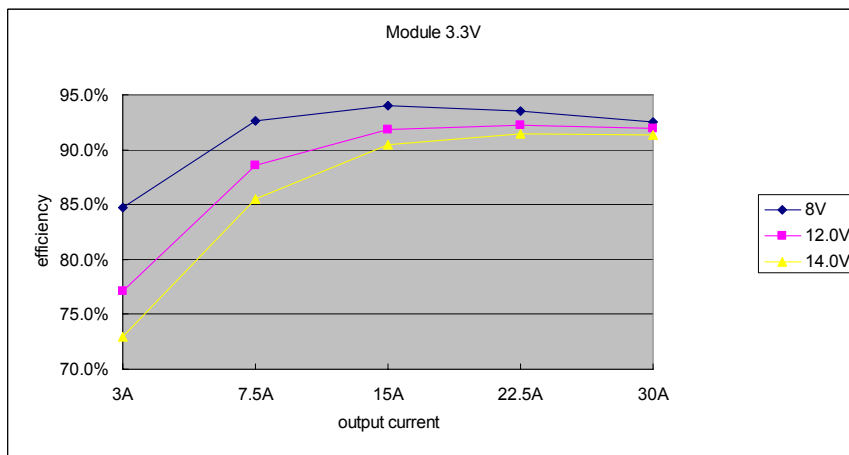
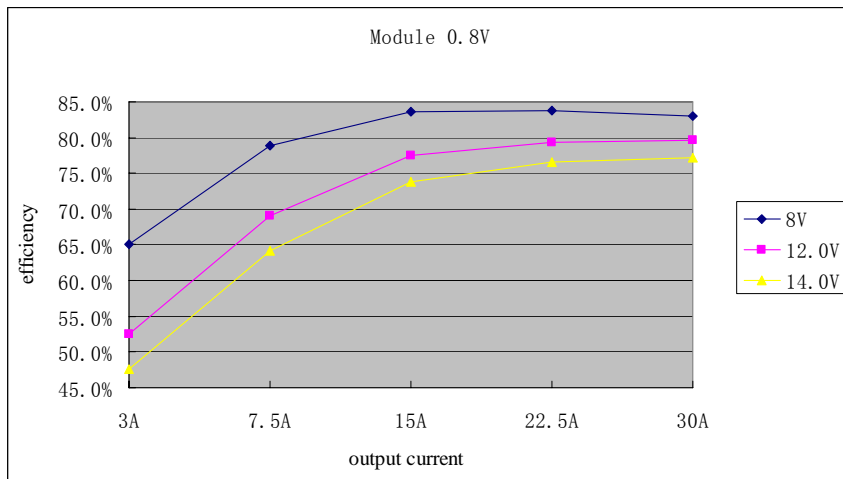

# NON-ISOLATED DC/DC CONVERTERS

8 Vdc - 14 Vdc Input 0.8 Vdc - 3.63 Vdc / 30 A Outputs



## Thermal Derating Curves

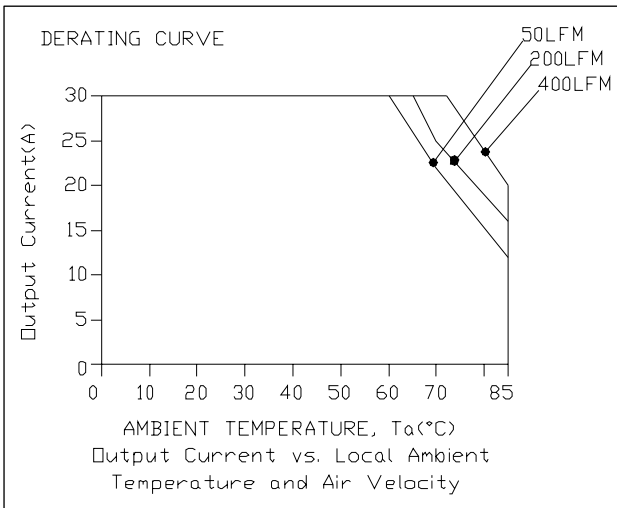

Vo=0.8 V

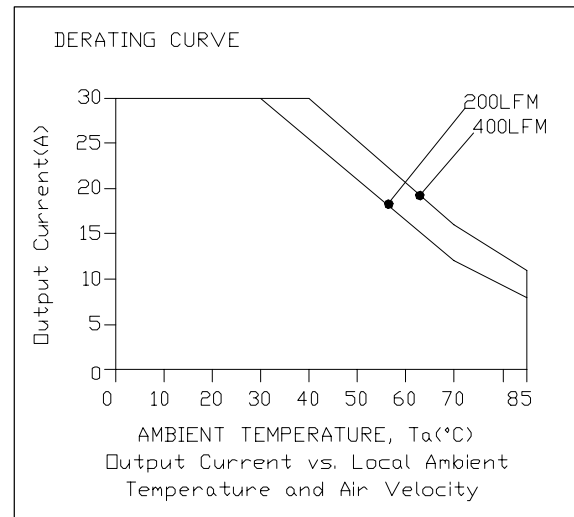

Vo=3.3 V

## Ripple and Noise Waveforms

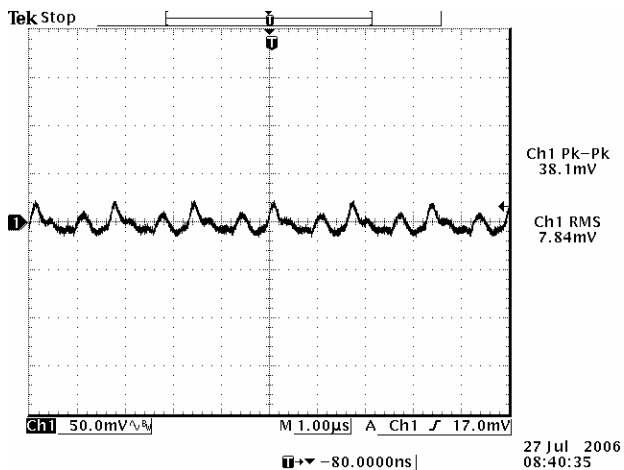

Vo=0.8 V

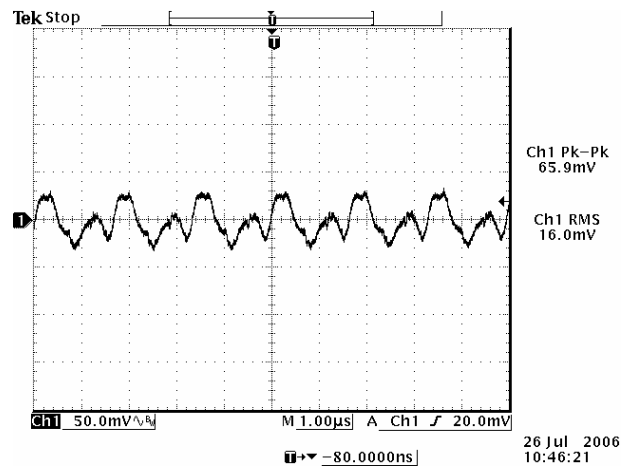

Vo=3.3 V

**Note:** Ripple and noise at full load, 12 V input, external load with 150 uF tantalum capacitor and 22 uF ceramic capacitor at the output,  $T_a=25$  deg C.

# NON-ISOLATED DC/DC CONVERTERS

8 Vdc - 14 Vdc Input 0.8 Vdc - 3.63 Vdc / 30 A Outputs



## Transient Response Waveforms

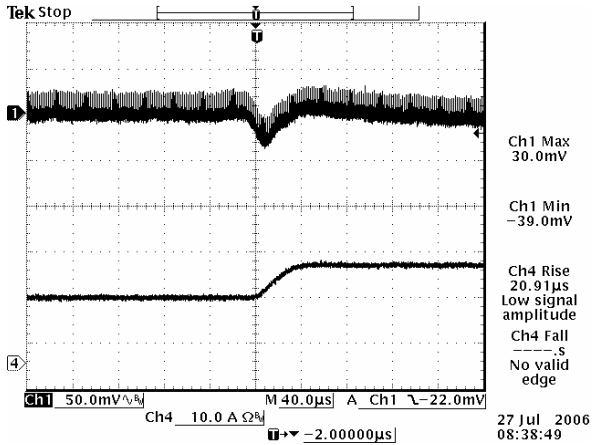

Vo=0.8 V 50% to 75% Load Transients

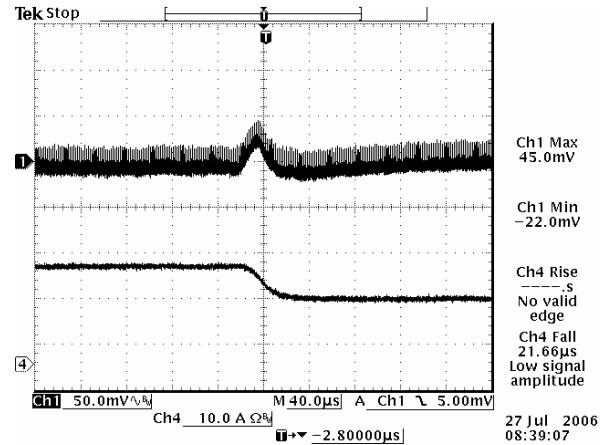

Vo=0.8 V 75% to 50% Load Transients

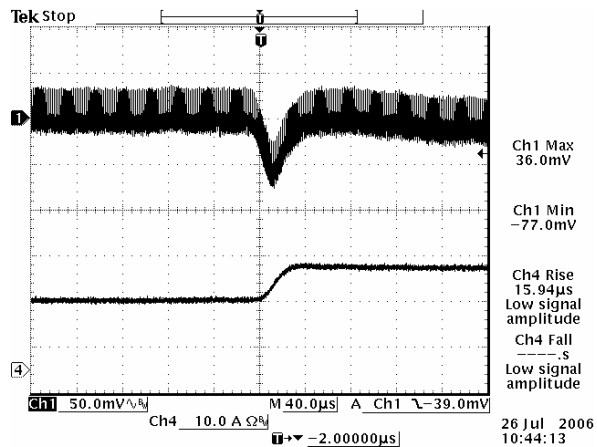

Vo=3.3 V 50% to 75% Load Transients

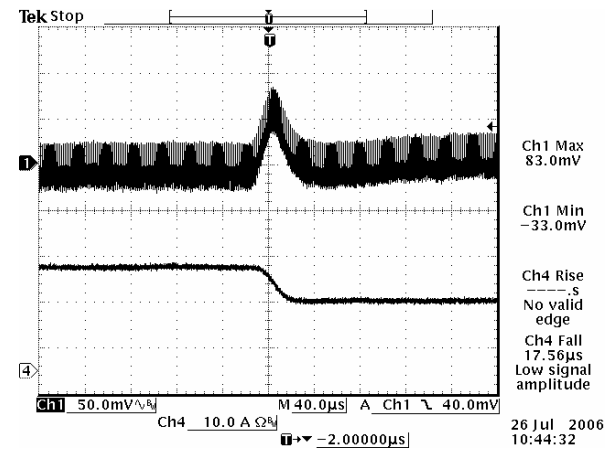

Vo=3.3 V 75% to 50% Load Transients

**Note:** Transient Response at  $V_{in}=12\text{ V}$ ,  $di/dt=0.5\text{ A}/\mu\text{S}$ , external load with 150  $\mu\text{F}$  tantalum capacitor and 22  $\mu\text{F}$  ceramic capacitor at the output, and  $T_a=25\text{ deg C}$ .

# NON-ISOLATED DC/DC CONVERTERS

8 Vdc - 14 Vdc Input 0.8 Vdc - 3.63 Vdc / 30 A Outputs



## Mechanical Outline

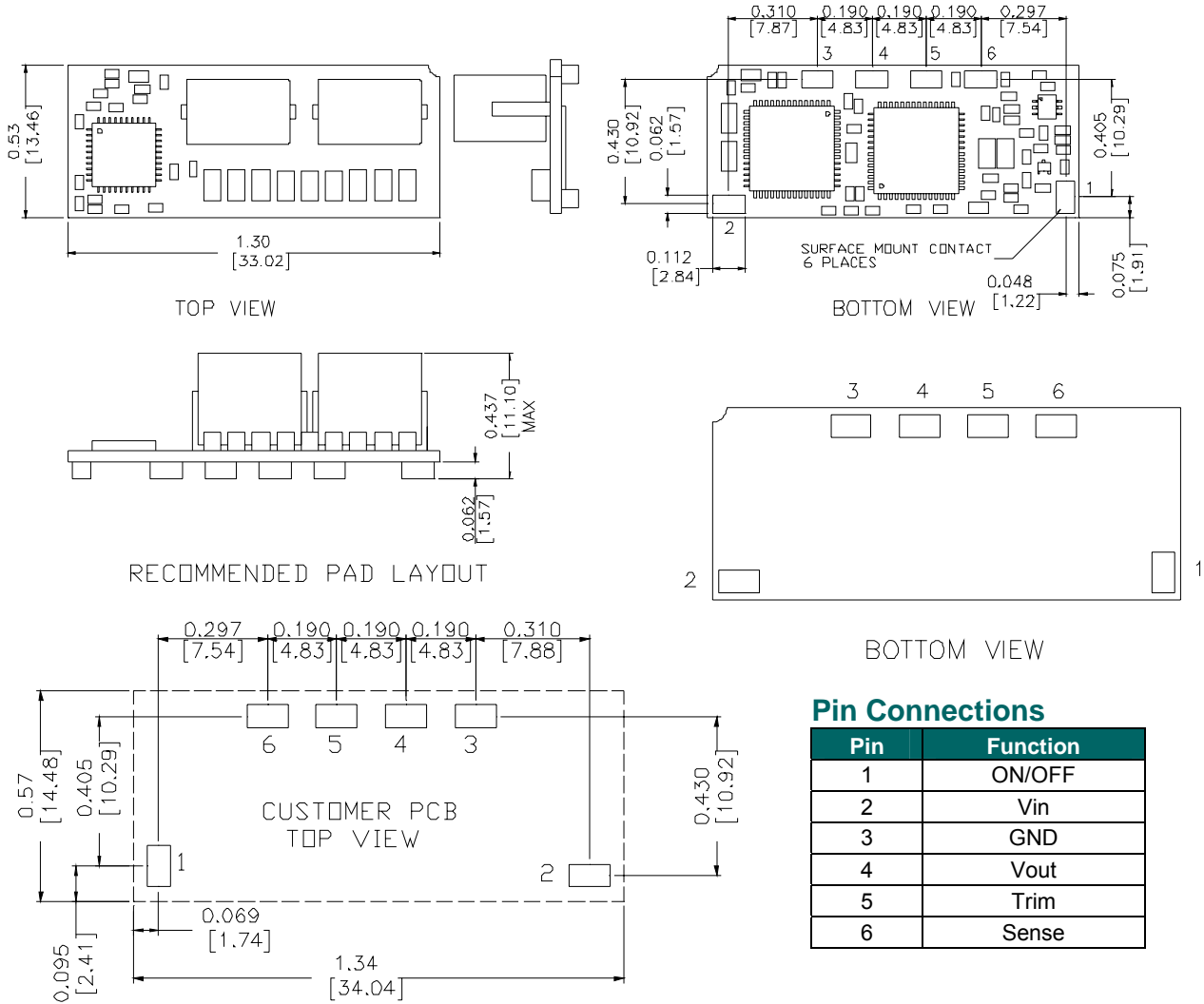

MIN: 0.14" \* 0.095" (3.56mm \* 2.41mm)  
 MAX: 0.165" \* 0.11" (4.19mm \* 2.79mm)

### Pin Connections

Pin	Function
1	ON/OFF
2	Vin
3	GND
4	Vout
5	Trim
6	Sense

### RoHS Compliance

Complies with the European Directive 2002/95/EC, calling for the elimination of lead and other hazardous substances from electronic products.



©2007 Bel Fuse Inc. Specifications subject to change without notice. 0118076

#### CORPORATE

**Bel Fuse Inc.**  
 206 Van Vorst Street  
 Jersey City, NJ 07302  
 Tel 201-432-0463  
 Fax 201-432-9542  
[www.belfuse.com](http://www.belfuse.com)

#### FAR EAST

**Bel Fuse Ltd.**  
 8F/ 8 Luk Hop Street  
 San Po Kong  
 Kowloon, Hong Kong  
 Tel 852-2328-5515  
 Fax 852-2352-3706  
[www.belfuse.com](http://www.belfuse.com)

#### EUROPE

**Bel Fuse Europe Ltd.**  
 Preston Technology Management Centre  
 Marsh Lane, Suite G7, Preston  
 Lancashire, PR1 8UD, U.K.  
 Tel 44-1772-556601  
 Fax 44-1772-888366  
[www.belfuse.com](http://www.belfuse.com)