

NON-ISOLATED DC/DC CONVERTERS

4.5 Vdc - 13.8 Vdc Input

0.59 Vdc - 5.1 Vdc / 3 A Output

bel
POWER PRODUCTS

VRAE-03E1A0

RoHS Compliant

Rev.C

- Non-Isolated
- High Efficiency
- Fixed Frequency
- Low Cost
- Wide Input
- Under-Voltage Lockout
- Wide Trim
- OCP/SCP
- Remote On/Off



Description

The Bel VRAE-03E1A0 is part of the non-isolated dc/dc converter Power Module series. The modules use a SIP package. These converters are available in a range of output voltages from 0.59 Vdc to 5.1 Vdc over a wide range of input voltage ($V_{IN} = 4.5 \text{ Vdc} - 13.8 \text{ Vdc}$). The efficiency is typically 91% at 3.3 Vout ($V_{in}=12 \text{ Vdc}$) at full load.

Part Selection

Output Voltage	Input Voltage	Max. Output Current	Max. Output Power	Typical Efficiency	Model Number
0.59 V - 5.1 V	4.5 V - 13.8 V	3 A	15 W	91%	VRAE-03E1A0

Notes: 1. All part numbers above indicate RoHS 6. Change the second letter "R" to "7" for RoHS 5 part numbers.
2. Add "G" suffix at the end of the model numbers listed above to indicate "Tray Packaging".

Absolute Maximum Ratings

Parameter	Min	Typ	Max	Notes
Input Supply Voltage	-0.3 V	-	15 V	
Ambient Temperature	0 °C	-	70 °C	
Storage Temperature	-55 °C	-	125 °C	

Note: All specifications are typical at 25 °C unless otherwise stated.

Input Specifications

Parameter	Min	Typ	Max	Notes
Operating Input Voltage				
$V_{o,set} \leq 3.63 \text{ V}$	4.5 V	-	13.8 V	
$V_{o,set} > 3.63 \text{ V}$	7.0 V	-	13.8 V	
Input Current (full load)	-	-	TBD	An input line fuse must always be used.
Input Current (no load)	-	40 mA	100 mA	
Remote Off Input Current	-	10 mA	25 mA	
Input Reflected Ripple Current (pk-pk)	-	30 mA	50 mA	With simulated source impedance of 1000 nH, 5 Hz to 20 MHz. Use a 1000 uF/25 V AL-Cap with ESR=0.03 ohm max and 2*100 Uf/25V Tan-Cap with ESR=0.013 ohm max at 100 kHz@25°C.
Input Reflected Ripple Current (rms)	-	10 mA	20 mA	
I^2t Inrush Current Transient	-	-	1 A ² s	
Turn on Voltage Threshold	4.15 V	4.3 V	4.45 V	A 30.1K resistor is connected from Enable to Vin.
Turn off Voltage Threshold	3.7 V	4.1 V	4.3 V	

Note: All specifications are typical at 25 °C unless otherwise stated.

NON-ISOLATED DC/DC CONVERTERS

4.5 Vdc - 13.8 Vdc Input

0.59 Vdc - 5.1 Vdc / 3 A Output



Output Specifications

Parameter	Min	Typ	Max	Notes	
Output Voltage Set Point	-2%Vo,set	-	2%Vo,set	Vin= 12 V, Iout=full load	
Load Regulation	-	±0.2%Vo,set	±0.5%Vo,set		
Line Regulation	-	±0.2%Vo,set	±0.5%Vo,set		
Temperature Regulation	-	0.3%Vo,set	-		
Output Current	0 A	-	3 A		
Output DC Current Limit	3.6 A	5 A	7 A		
Output Ripple and Noise (pk-pk)	-	60 mV	100 mV	0-20 MHz BW, with a 10 uF tantalum capacitor and 1 uF ceramic capacitor at the output.	
Output Ripple and Noise (rms)	-	20 mV	40 mV		
Short Circuit Surge Transient	-	-	2 A ² s	Vo≤20 mV, Hiccup Mode	
Turn on Time	-	3 mS	5 mS		
Overshoot at Turn on	-	-	1%		
Output Capacitance	0 uF	-	1000 uF		
Transient Response					
50% ~ 100% Max Load	Vo =All	-	120 mV	200 mV	di/dt=0.25 A/uS; Vin=12 V; with a 10 uF tantalum capacitor and a 1 uF ceramic capacitor at the output.
Settling Time		-	20 uS	50 uS	
100% ~ 50% Max Load		-	120 mV	200 mV	
Settling Time		-	20 uS	50 uS	

Note: All specifications are typical at normal input, full load at Ta= 25°C unless otherwise stated.

General Specifications

Parameter	Min	Typ	Max	Notes
Efficiency				Vin=12 V
Vo=5.0 V	91%	93%	-	
Vo=3.3 V	89%	91%	-	
Vo=2.5 V	87%	89%	-	
Vo=1.8 V	84%	86%	-	
Vo=1.5 V	83%	85%	-	
Vo=1.2 V	80%	82%	-	
Vo=0.9 V	73%	75%	-	
Switching Frequency	-	500 kHz	-	
Output Voltage Trim Range (Wide Trim)	0.591 V	-	5.1 V	
MTBF	TBD			Calculated Per Bell Core SR-332 (Io = 80% load; Vin=12 V; Vo=3.3 V; Ta = 25 °C)
Dimensions				
Inches (L x W x H)	0.65 x 0.41 x 0.32			
Millimeters (L x W x H)	16.51 x 10.41 x 8.13			
Weight	-	TBD	-	

Note: All specifications are typical at 25 °C unless otherwise stated.

NON-ISOLATED DC/DC CONVERTERS

4.5 Vdc - 13.8 Vdc Input

0.59 Vdc - 5.1 Vdc / 3 A Output

bel
POWER PRODUCTS

Control Specifications

Parameter	Min	Typ	Max	Notes
Remote On/Off				
Signal Low (Unit Off)	-0.3 V	-	0.4 V	Remote On/Off Pin is open, the unit is off.
Signal High (Unit On)	2.0 V	-	5.5 V	

Output Trim Equations

Equation for calculating the trim resistor given the desired output voltage (V_o) is shown below. The R_{trim} resistor should be connected between the trim pin and GND pin.

$$R_{trim} = \frac{1.182}{V_o - 0.591} k\Omega$$

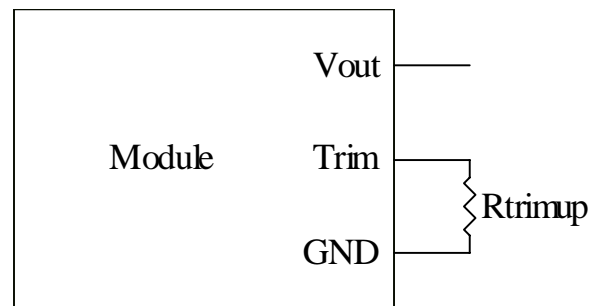

NON-ISOLATED DC/DC CONVERTERS

4.5 Vdc - 13.8 Vdc Input

0.59 Vdc - 5.1 Vdc / 3 A Output



Efficiency Data

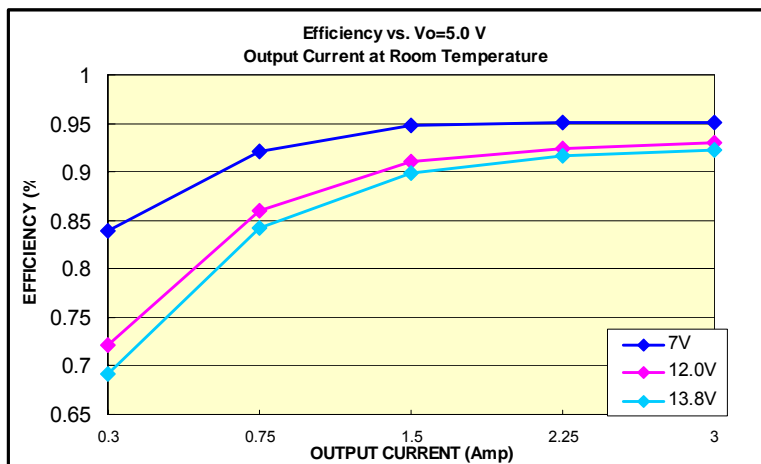
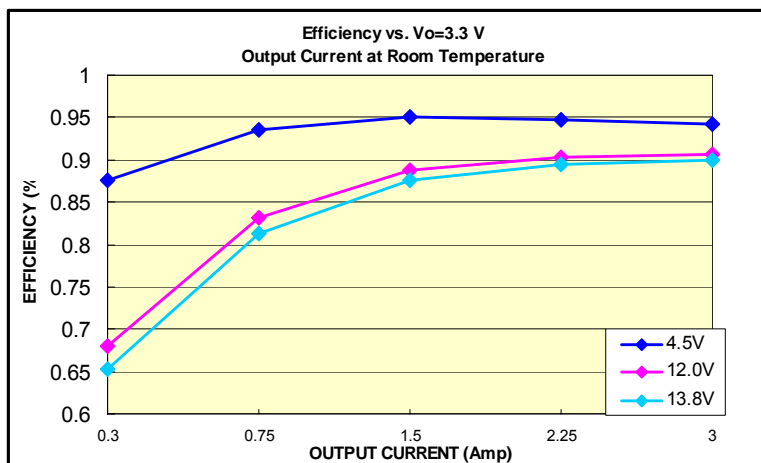
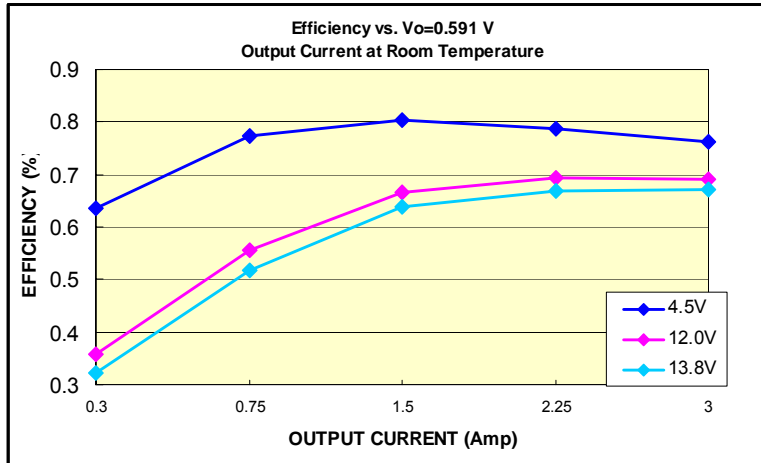

NON-ISOLATED DC/DC CONVERTERS

4.5 Vdc - 13.8 Vdc Input

0.59 Vdc - 5.1 Vdc / 3 A Output



Thermal Derating Curves

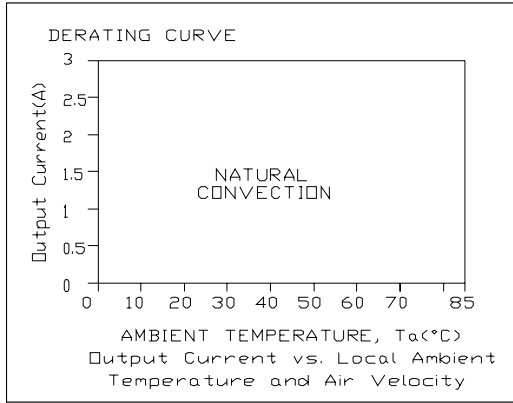

Vin=12 V, Vout=5 V

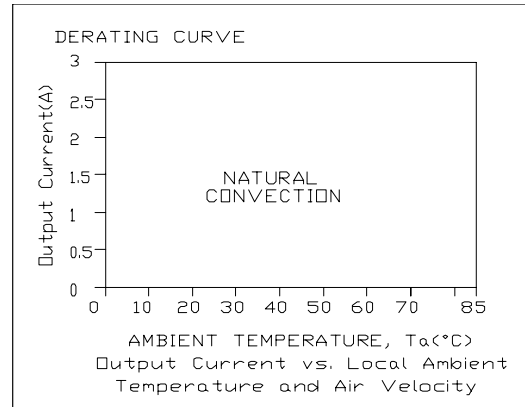

Vin=12 V, Vout=3.3 V

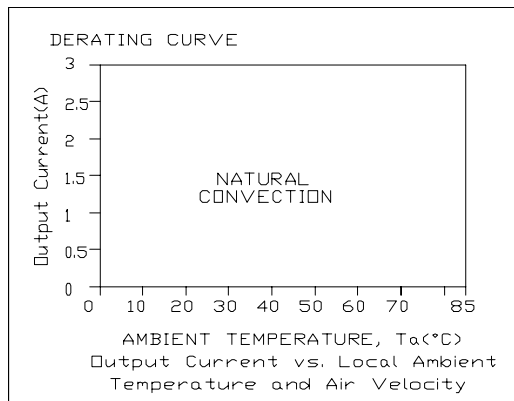

Vin=12 V, Vout=2.5 V

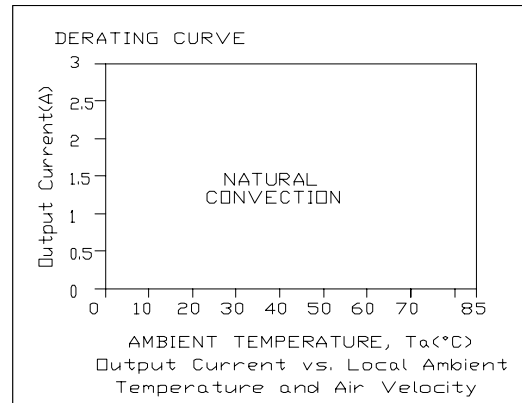

Vin=12 V, Vout=1.2 V

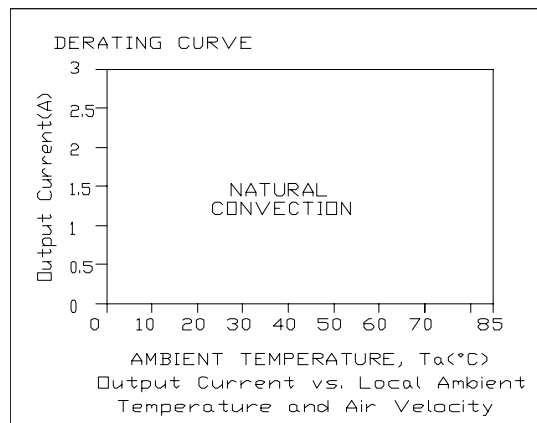

Vin=12 V, Vout=0.59 V

NON-ISOLATED DC/DC CONVERTERS

4.5 Vdc - 13.8 Vdc Input

0.59 Vdc - 5.1 Vdc / 3 A Output



Ripple and Noise Waveform

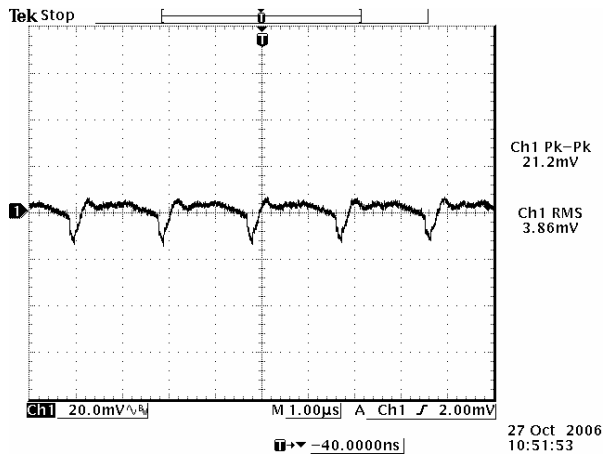

12 V input, 0.591 V output

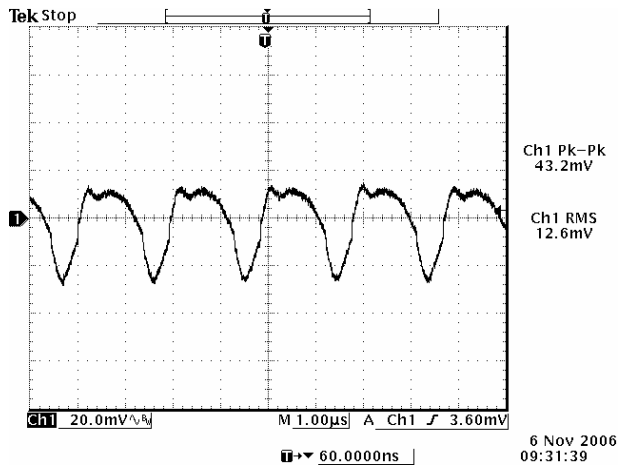

12 V input, 3.3 V output

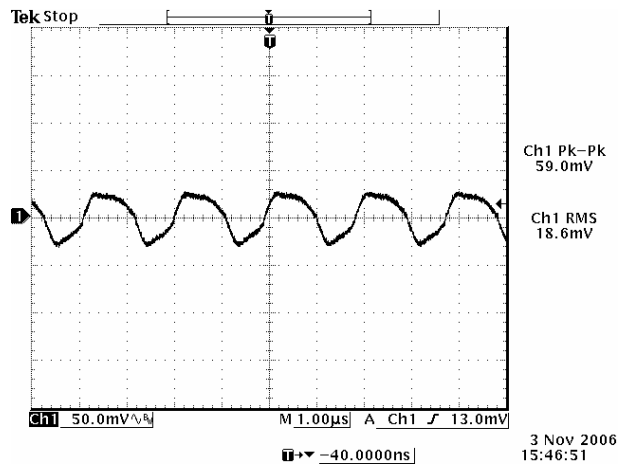

12 V input, 5.0 V output

Note: Ripple and noise at full load, 0-20MHz BW, with a 10 uF tantalum cap and a 1 uF ceramic cap at the output, Ta=25 deg C.

NON-ISOLATED DC/DC CONVERTERS

4.5 Vdc - 13.8 Vdc Input

0.59 Vdc - 5.1 Vdc / 3 A Output



Transient Response Waveforms

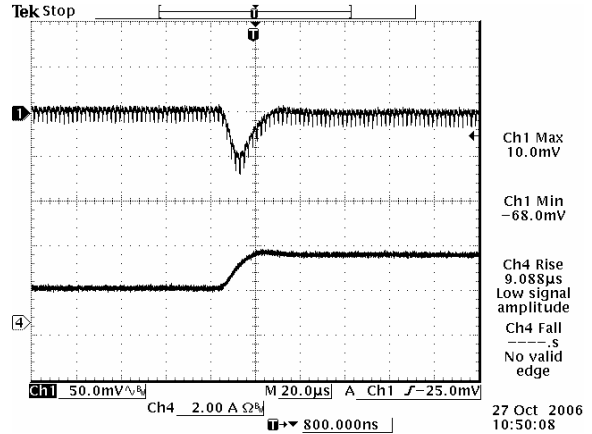
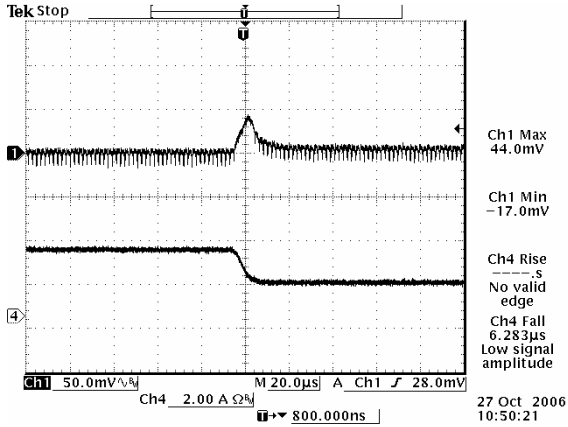

100% to 50% load step at 12 V input, 0.591 V output

50% to 100% load step at 12 V input, 0.591 V output

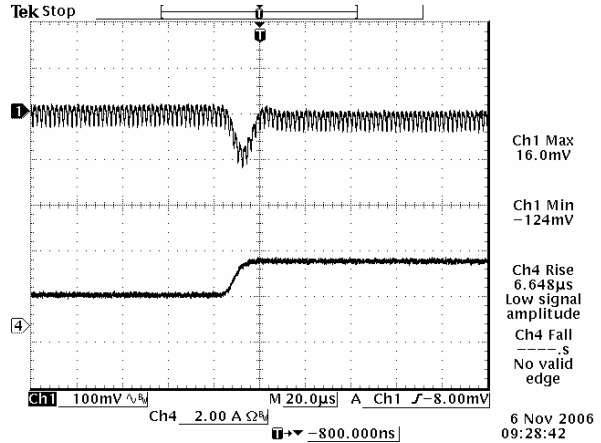
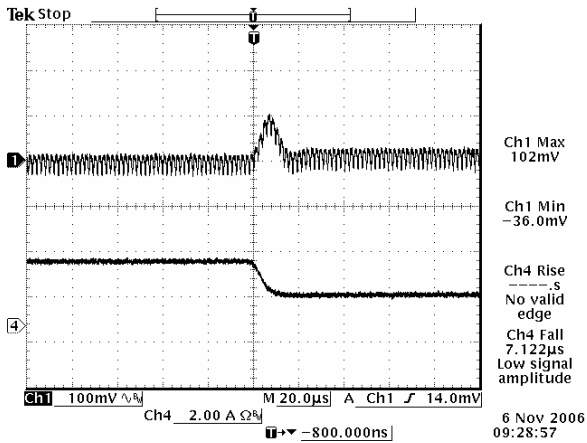

100% to 50% load step at 12 V input, 3.3 V output

50% to 100% load step at 12 V input, 3.3 V output

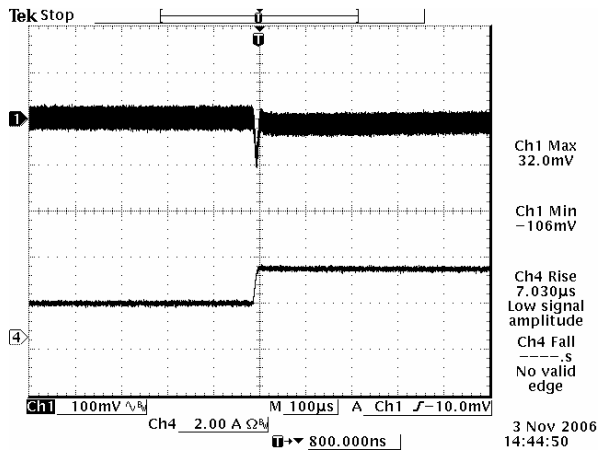
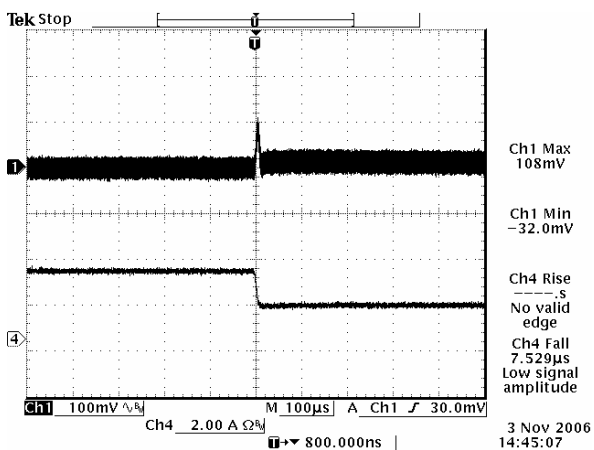

100% to 50% load step at 12 V input, 5.0 V output

50% to 100% load step at 12 V input, 5.0 V output

Note: Transient response at $di/dt=0.25$ A/ μ s, with a 1 μ F ceramic cap and a 10 μ F tantalum cap at the output, and $T_a=25$ deg C.

NON-ISOLATED DC/DC CONVERTERS

4.5 Vdc - 13.8 Vdc Input

0.59 Vdc - 5.1 Vdc / 3 A Output



Mechanical Outline

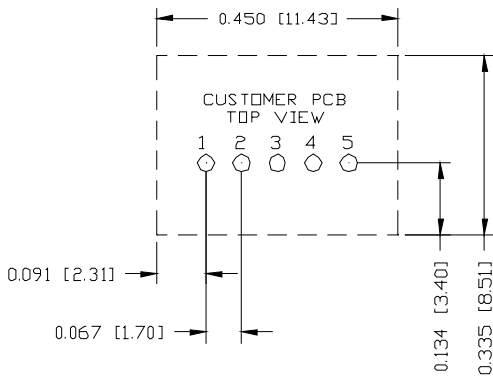
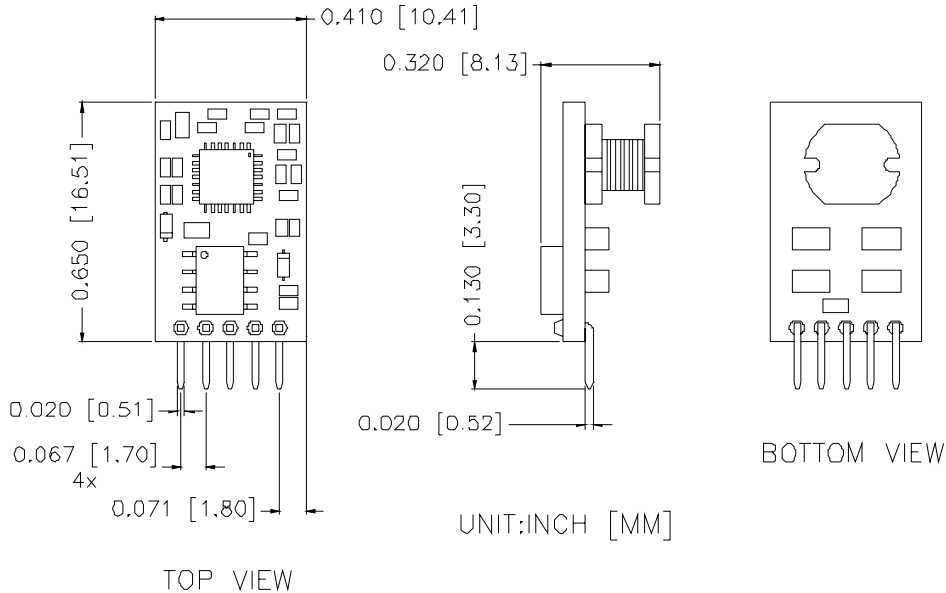

Pin Connections

Pin	Function
1	ENABLE
2	Vin
3	GND
4	Vout
5	Trim

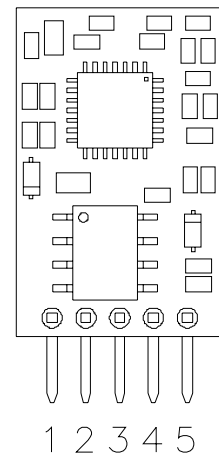

HOLE SIZE: $\Phi 0.035 \pm 0.003$ [0.89 \pm 0.08]

PAD SIZE: $\Phi 0.055 \pm 0.002$ [1.40 \pm 0.05]

RoHS Compliance

Complies with the European Directive 2002/95/EC, calling for the elimination of lead and other hazardous substances from electronic products.



©2007 Bel Fuse Inc. Specifications subject to change without notice. 062807

CORPORATE

Bel Fuse Inc.
206 Van Vorst Street
Jersey City, NJ 07302
Tel 201-432-0463
Fax 201-432-9542
www.belfuse.com

FAR EAST

Bel Fuse Ltd.
8F/ 8 Luk Hop Street
San Po Kong
Kowloon, Hong Kong
Tel 852-2328-5515
Fax 852-2352-3706
www.belfuse.com

EUROPE

Bel Fuse Europe Ltd.
Preston Technology Management Centre
Marsh Lane, Suite G7, Preston
Lancashire, PR1 8UD, U.K.
Tel 44-1772-556601
Fax 44-1772-888366
www.belfuse.com