

## NON-ISOLATED DC/DC CONVERTERS

2.4 Vdc - 5.5 Vdc Input

0.75 Vdc - 3.63 Vdc/10 A Output

**bel**  
POWER PRODUCTS

**VRBC-10F1Ax**

**RoHS Compliant**

**Rev.A**

- Non-Isolated
- High Efficiency
- High Power Density
- Fixed Frequency (300 kHz)
- OCP/SCP
- Over Temperature Protection
- Active Low/High (option)
- Under-Voltage Lockout (UVLO)
- Wide Input Range
- Wide Trim Range
- Remote On/Off
- Remote Sense
- Converter Can Sink and Source Current

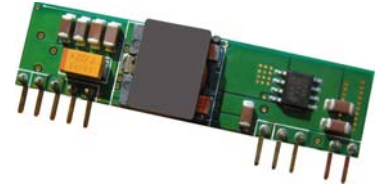

### Description

The Bel VRBC-10F1Ax modules are a series of non-isolated dc/dc converters that deliver up to 10 A of output current with full load efficiency of 94% at 3.3 Vdc output. These modules provide precisely regulated voltage programmable via external resistor from 0.75 Vdc to 3.63 Vdc over a wide range of input voltage (2.4 Vdc - 5.5 Vdc). The open-frame construction and small footprint enable designers to develop cost and space-efficient solutions. Standard features include remote On/Off, remote sense, over current protection, short current protection, wide input, and programmable output voltage.

### Part Selection

Output Voltage	Input Voltage	Max. Output Current	Max. Output Power	Typical Efficiency	Model Number Active Low	Model Number Active High
0.75 V - 3.63 V <sup>1</sup>	2.4 V - 5.5 V	10 A	36.3 W	94%	VRBC-10F1AL	VRBC-10F1A0

- Notes:**
1. These modules use a buck topology, so the output voltages must be 0.5 V less than the input voltage.
  2. Add "G" to the end of the Model Number to indicate Tray Packaging.
  3. All part numbers above indicate RoHS 6. Change the second letter "R" to "7" for RoHS 5 part numbers.

### Absolute Maximum Ratings

Parameter	Min	Typ	Max	Notes
Input Voltage (continuous)	-0.3 V	-	5.8 V	
Output Enable Terminal Voltage	-0.3 V	-	5.8 V	
Ambient Temperature	-40 °C	-	85 °C	
Storage Temperature	-55 °C	-	125 °C	

**Note:** All specifications are typical at 25 °C unless otherwise stated.

# NON-ISOLATED DC/DC CONVERTERS

2.4 Vdc - 5.5 Vdc Input

0.75 Vdc - 3.63 Vdc/10 A Output



## Input Specifications

Parameter	Min	Typ	Max	Notes
Input Voltage	2.4 V	-	5.5 V	$V_{o, set} \leq V_{in} - 0.5 V$
Input Current (full load)				
$V_o = 3.3 V$	-	7.0 A	8.06A	
$V_o = 1.8 V$	-	4.04 A	6.98A	
$V_o = 0.75 V$	-	1.89 A	4.06A	
Input Current (no load)	-	80 mA	-	
Remote Off Input Current	-	15 mA	22 mA	
Input Reflected Ripple Current (pk-pk)	-	120 mA	-	Tested with two 100 uF/10 V tantalum input capacitors (P/N: TPSC107K010R0075 AVX) & simulated source impedance of 1 uH, 5 Hz to 20 MHz.
Input Reflected Ripple Current (rms)	-	35 mA	-	
$I^2t$ Inrush Current Transient	-	-	0.2 A <sup>2</sup> s	
Turn-on Voltage Threshold	-	2.2 V	-	
Turn-off Voltage Threshold	-	2.0 V	-	

**Note:** All specifications are typical at 25 °C unless otherwise stated.

## Output Specifications

Parameter	Min	Typ	Max	Notes
Output Voltage Set Point	-2% $V_{o, set}$	-	2% $V_{o, set}$	$V_{in} = 5 V$ , $I_o = I_{o, max}$ full load
Output Voltage Set Point	-3% $V_{o, set}$	-	3% $V_{o, set}$	Over all operating input voltages, resistive loads and temperature conditions
Load Regulation	-	0.4% $V_{o, set}$	-	$I_o = I_o$ , min to $I_o$ , max
Line Regulation	-	0.3% $V_{o, set}$	-	$V_{in} = V_{in}$ , min to $V_{in}$ , max
Regulation Over Temperature (-40 °C to +85 °C)	-	0.5% $V_{o, set}$	-	$T_{ref} = T_a$ , min to $T_a$ , max
Output Current	0 A	-	10 A	
Current Limit Threshold	15 A	-	30 A	
Short Circuit Surge Transient	-	-	2 A <sup>2</sup> s	
Ripple and Noise (pk-pk)	-	25 mV	50 mV	Tested with 0-20 MHz, BW 10 uF/16 V tantalum capacitor & 1 uF/10 V TDK ceramic capacitor at the output
Ripple and Noise (rms)	-	8 mV	15 mV	
Turn on Time	-	4 mS	8 mS	
Overshoot at Turn on	-	0% $V_{o, set}$	3% $V_{o, set}$	
Output Capacitance				
ESR $\geq$ 1 mohm	0 uF	-	1000 uF	
ESR $\geq$ 10 mohm	0 uF	-	4700 uF	
<b>Transient Response</b>				
50% ~ 100% Max Load	All	-	200 mV	di/dt=2.5 A/uS; $V_{in} = 5 V$ ; and with 10 uF/16 V tantalum capacitor & 1 uF/10 V ceramic capacitor at the output
Settling Time		-	25 uS	
100% ~ 50% Max Load	All	-	200 mV	
Settling Time		-	25 uS	
50% ~ 100% Max Load	All	-	120 mV	di/dt=2.5 A/uS; $V_{in} = 5 V$ ; and with two 150 uF/10 V tantalum capacitors & 1 uF/10 V ceramic capacitor at the output
Settling Time		-	50 uS	
100% ~ 50% Max Load		-	120 mV	
Settling Time		-	50 uS	

**Note:** All specifications are typical at nominal input ( $V_{in} = 5 V$ ), full load at 25 °C unless otherwise stated.

# NON-ISOLATED DC/DC CONVERTERS

2.4 Vdc - 5.5 Vdc Input

0.75 Vdc - 3.63 Vdc/10 A Output



## General Specifications

Parameter	Min	Typ	Max	Notes
Efficiency				Measured at Vin=5 V, full load (current source)
Vo=3.3 V	91%	94%	-	
Vo=1.8 V	86%	89%	-	
Vo=0.75 V	77%	80 %	-	
Switching Frequency	250 kHz	300 kHz	350 kHz	
Over Temperature Shutdown	-	125 °C	-	
Output Trim Range (Wide Trim)	0.7525 V	-	3.63 V	
Remote Sense Compensation	-	-	10%	
MTBF	6,900,000 hours			Calculated Per Bell Core SR-332 (Io = Nominal; Ta = 25 °C)
Dimensions				
Inches (L x W x H)	2.0 x 0.5 x 0.363			
Millimeters (L x W x H)	50.8 x 12.7 x 9.23			
Weight	-	8.3 g	-	

**Note:** All specifications are typical at 25 °C unless otherwise stated.

## Control Specifications

Parameter	Min	Typ	Max	Notes
Signal Low (Unit Off)	-0.3 V	-	0.3 V	VRBC-10F1A0; Remote On/Off pin open, Unit on.
Signal High (Unit On)	1.5 V	-	5.8 V	
Signal Low (Unit On)	-0.3 V	-	0.3 V	VRBC-10F1AL; Remote On/Off pin open, Unit on.
Signal High (Unit Off)	1.5 V	-	5.8 V	

## Output Trim Equations

Equation for calculating the trim resistor (in kΩ) given the desired adjusted voltage (Vadj) is shown below. The Trim Up resistor should be connected between the Trim pin and Ground.

$$R_{trim} = \frac{21.07}{V_{adj} - 0.7525} - 5.11$$

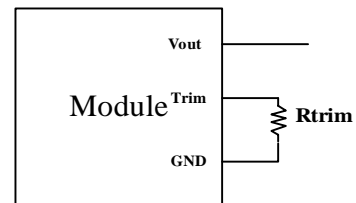

Equation for calculating the trim voltage (in V) given the desired adjusted voltage (Vadj) is shown below. The Trim Up voltage should be connected between the Trim pin and Ground.

$$V_{rim} = 0.7 - 0.1698 \times (V_{adj} - 0.7525)$$

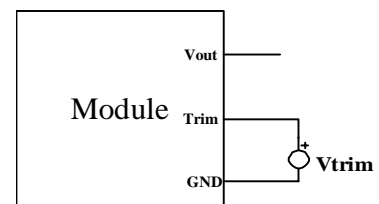

# NON-ISOLATED DC/DC CONVERTERS

2.4 Vdc - 5.5 Vdc Input

0.75 Vdc - 3.63 Vdc/10 A Output



## Efficiency Data

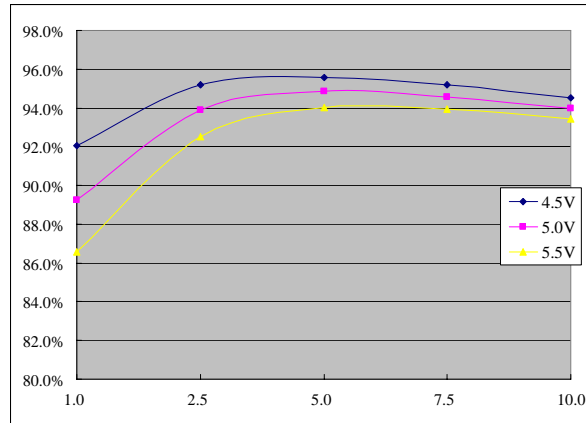

Vo=3.3 V

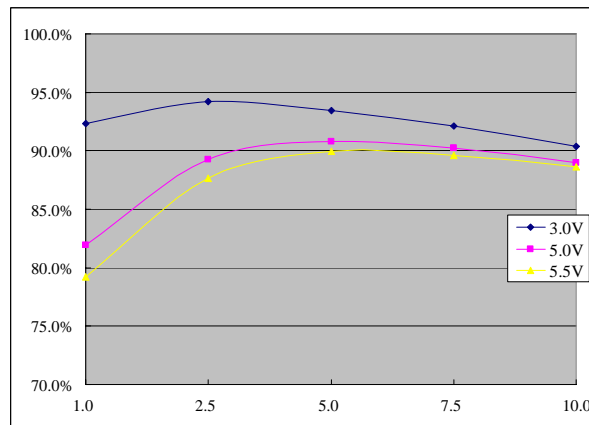

Vo=1.8 V

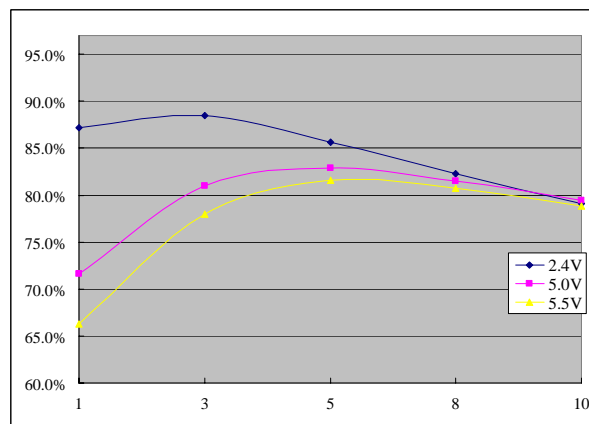

Vo=0.75 V

# NON-ISOLATED DC/DC CONVERTERS

2.4 Vdc - 5.5 Vdc Input

0.75 Vdc - 3.63 Vdc/10 A Output



## Thermal Derating Curves

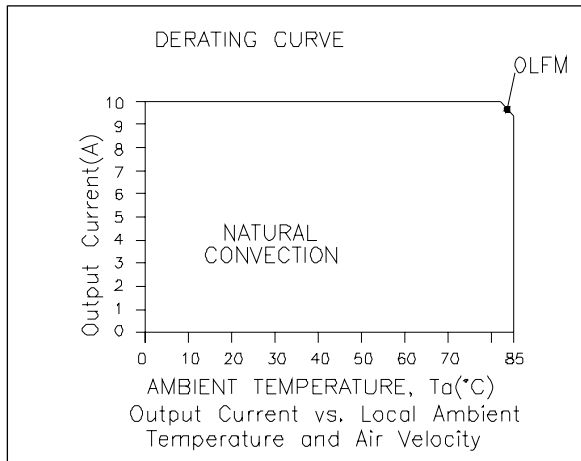

$V_{in} = 5.0\text{ V}$  ,  $V_o = 3.3\text{ V}$

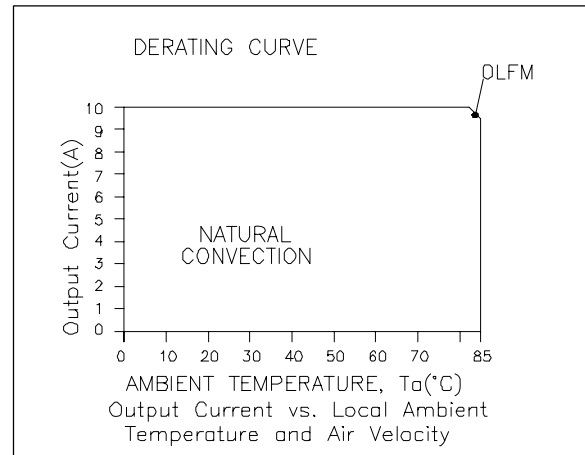

$V_{in} = 5.0\text{ V}$  ,  $V_o = 1.8\text{ V}$

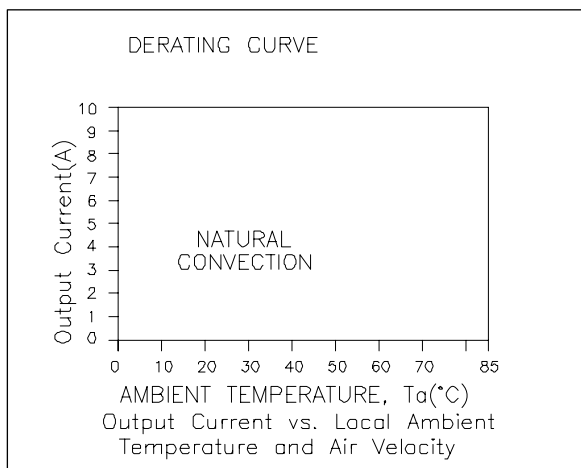

$V_{in} = 5.0\text{ V}$  ,  $V_o = 0.75\text{ V}$

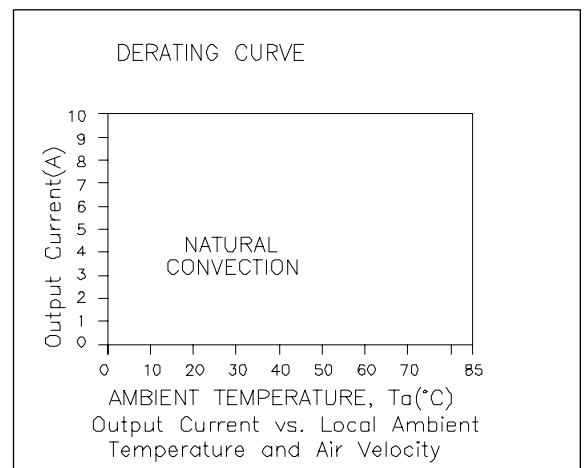

$V_{in} = 3.3\text{ V}$  ,  $V_o = 0.75\text{ V} / 1.8\text{ V} / 2.5\text{ V}$

## NON-ISOLATED DC/DC CONVERTERS

2.4 Vdc - 5.5 Vdc Input

0.75 Vdc - 3.63 Vdc/10 A Output

**bel**  
POWER PRODUCTS

### Ripple and Noise Waveforms

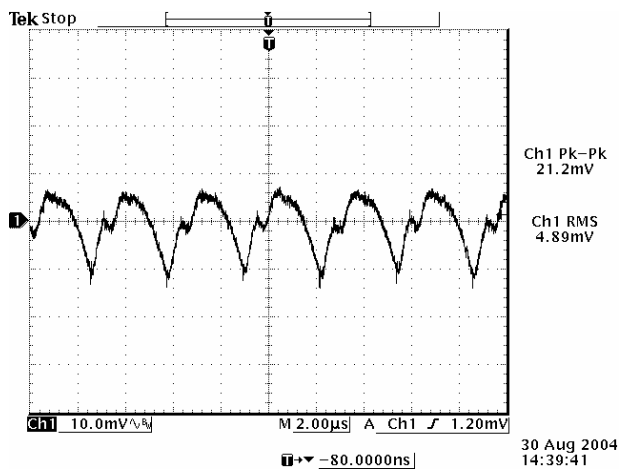

5.0 V input, 0.75 V output

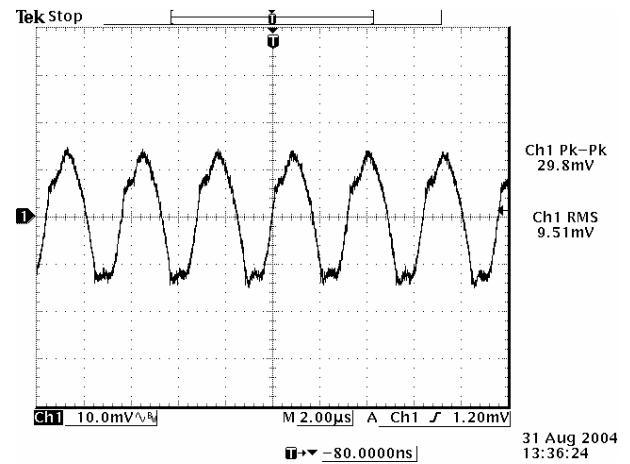

5.0 V input, 1.8 V output

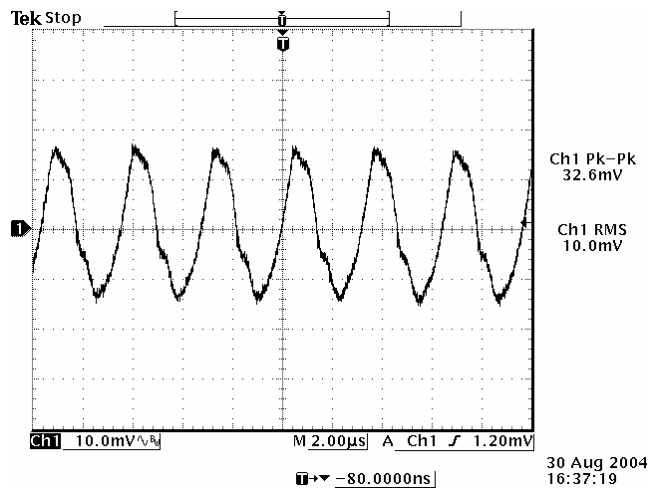

5.0 V input, 3.3 V output

**Note:** Ripple and noise at full load, 0-20 MHz BW, 10  $\mu$ F/16 V tantalum capacitor and 1 $\mu$ F/10 V ceramic capacitor at the output,  $T_a=25$  deg C.

# NON-ISOLATED DC/DC CONVERTERS

2.4 Vdc - 5.5 Vdc Input

0.75 Vdc - 3.63 Vdc/10 A Output



## Transient Response Waveforms

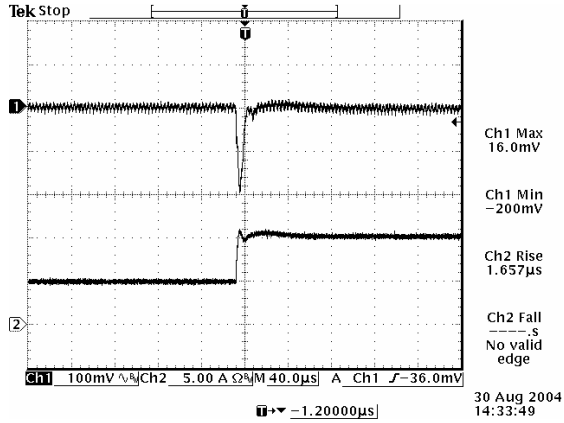

50% to 100% load step at 0.75 Vdc output

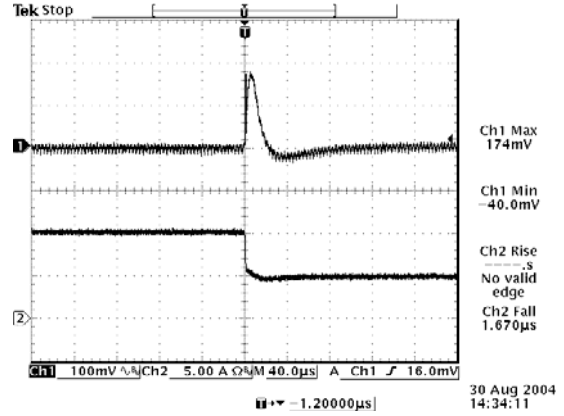

100% to 50% load step at 0.75 Vdc output

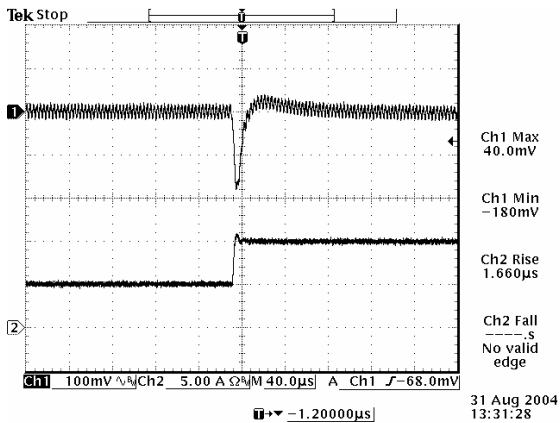

50% to 100% load step at 1.8 Vdc output

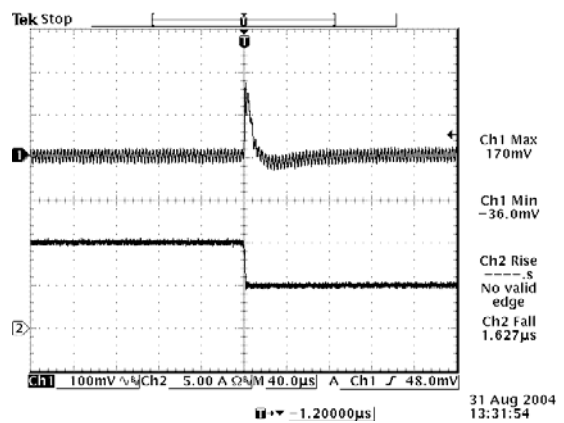

100% to 50% load step at 1.8 Vdc output

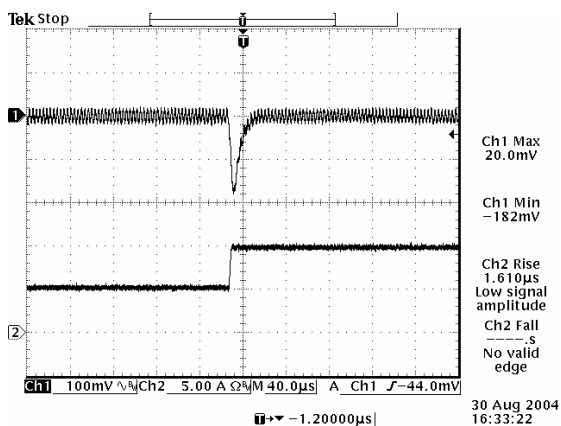

50% to 100% load step at 3.3 Vdc output

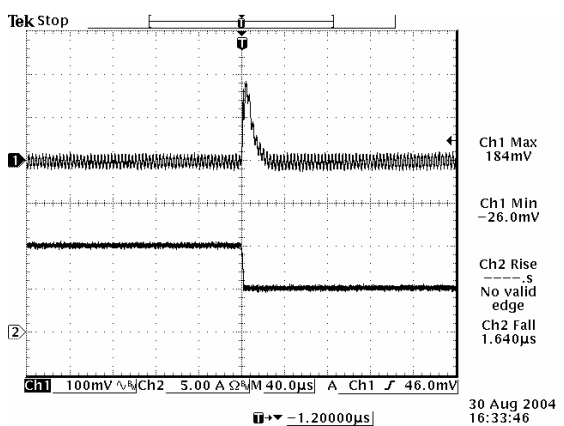

100% to 50% load step at 3.3 Vdc output

**Note:** Transient response at 5 Vdc input,  $di/dt=2.5$  A/ $\mu$ s, with 10  $\mu$ F/16 V tantalum cap and 1 $\mu$ F/10 V ceramic cap at the output, and  $T_a=25$  deg C.

# NON-ISOLATED DC/DC CONVERTERS

2.4 Vdc - 5.5 Vdc Input

0.75 Vdc - 3.63 Vdc/10 A Output



## Mechanical Outline

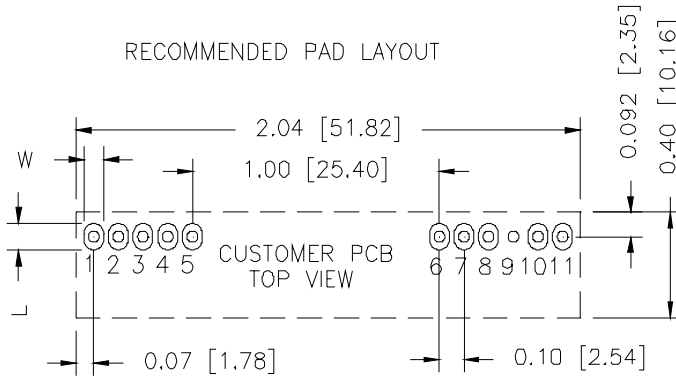
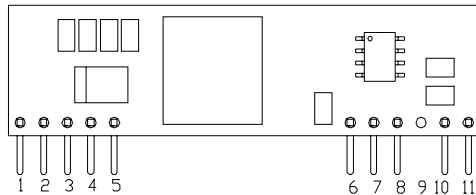
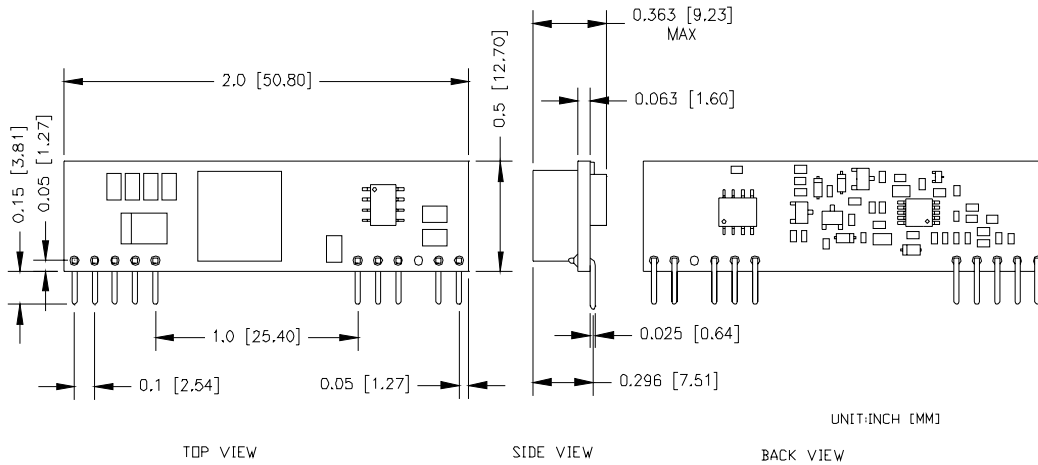

HOLE SIZE:  $\varnothing 0.043 \pm 0.003$  [1.08  $\pm$  0.08]  
 PAD SIZE: W  $0.063 \pm 0.002$  [1.63  $\pm$  0.05]  
 L  $0.10 \pm 0.004$  [2.54  $\pm$  0.10] BOTH SIDE

## Pin Connections

Pin	Function
1	Vout
2	Vout
3	Remote Sense
4	Vout
5	Ground
6	Ground
7	Vin
8	Vin
9	N/A
10	Trim
11	Remote On/Off

## RoHS Compliance

Complies with the European Directive 2002/95/EC, calling for the elimination of lead and other hazardous substances from electronic products.



©2007 Bel Fuse Inc. Specifications subject to change without notice. 011807

### CORPORATE

**Bel Fuse Inc.**  
 206 Van Vorst Street  
 Jersey City, NJ 07302  
 Tel 201-432-0463  
 Fax 201-432-9542  
[www.belfuse.com](http://www.belfuse.com)

### FAR EAST

**Bel Fuse Ltd.**  
 8F/ 8 Luk Hop Street  
 San Po Kong  
 Kowloon, Hong Kong  
 Tel 852-2328-5515  
 Fax 852-2352-3706  
[www.belfuse.com](http://www.belfuse.com)

### EUROPE

**Bel Fuse Europe Ltd.**  
 Preston Technology Management Centre  
 Marsh Lane, Suite G7, Preston  
 Lancashire, PR1 8UD, U.K.  
 Tel 44-1772-556601  
 Fax 44-1772-888366  
[www.belfuse.com](http://www.belfuse.com)