

NON-ISOLATED DC/DC CONVERTERS

8.3 Vdc - 14 Vdc Input

0.75 Vdc - 5.5 Vdc/16 A Output

bel
POWER PRODUCTS

VRBC-16A1Ax

RoHS Compliant

Rev.A

- Non-Isolated
- High Efficiency
- High Power Density
- Excellent Thermal Performance
- Low Cost
- Fixed Frequency
- Able to Sink & Source Current
- Vout Prebias
- Industrial Temperature Range
- Under-voltage Lockout (UVLO)
- Over Temperature Shutdown
- OCP/SCP
- Wide Input
- Wide Trim
- Remote On/Off
- Active Low/High (option)
- Remote Sense

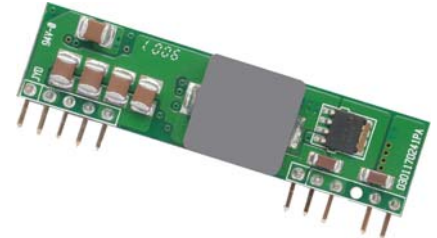

Description

The Bel VRBC-16A1Ax is part of the non-isolated dc/dc converter Power Module series. The modules use a SIP package. These converters are available in a range of output voltages from 0.75 Vdc to 5.0 Vdc over a wide range of input voltage ($V_{in} = 8.3 \text{ Vdc} - 14 \text{ Vdc}$). The efficiency is typically 92% at 3.3 Vout at full load.

Part Selection

Output Voltage	Input Voltage	Max. Output Current	Max. Output Power	Typical Efficiency	Model Number Active Low	Model Number Active High
0.75 V - 5.5 V	8.3 V - 14 V	16 A	80 W	94%	VRBC-16A1AL	VRBC-16A1A0

- Notes:**
1. Change the last character to "C" to indicate 0.20" pin length and active low.
 2. Add "G" suffix at the end of the model number to indicate Tray Packaging.
 3. All part numbers above indicate RoHS 6. Change the second letter "R" to "7" for RoHS 5 part numbers.

Absolute Maximum Ratings

Parameter	Min	Typ	Max	Notes
Input Voltage (continuous)	-0.3 V	-	15 V	
Output Enable Terminal Voltage	-0.3 V	-	15 V	
Ambient Temperature	-40 °C	-	85 °C	
Storage Temperature	-55 °C	-	125 °C	

Note: All specifications are typical at 25 °C unless otherwise stated.

NON-ISOLATED DC/DC CONVERTERS

8.3 Vdc - 14 Vdc Input

0.75 Vdc - 5.5 Vdc/16 A Output



Input Specifications

Parameter	Min	Typ	Max	Notes
Input Voltage				
Vo, set ≤ 3.63 V	8.3 V	12 V	14 V	
Vo, set > 3.63 V	8.3 V	12 V	13.2 V	
Input Current ¹ (full load)	-	-	11 A	
Input Current (no load)	-	100 mA	-	
Remote Off Input Current	-	2 mA	-	
Input Reflected Ripple Current (rms)	-	-	150 mA	With simulated source impedance of 1000 nH, 5 Hz to 20 MHz, use a 1000 uF/25 V AL-Cap with ESR=0.03 ohm max and 6 x 47 uF/16 V tantalum cap with ESR=0.013 ohm max, at 100 kHz
Input Reflected Ripple Current (pk-pk)	-	-	400 mA	
I ² t Inrush Current Transient	-	0.2 A ² s	0.4 A ² s	
Turn-on Voltage Threshold	-	7.8 V	-	
Turn-off Voltage Threshold	-	7.3 V	-	

Notes: 1. This power module is not internally fused. An input line fuse must always be used.
All specifications are typical at 25 °C unless otherwise stated.

Output Specifications

Parameter	Min	Typ	Max	Notes
Output Voltage Set Point	-2% Vo,set	-	2% Vo,set	Vin=12 V, full load
Load Regulation	-	0.2% Vo,set	-	Io=Io, min to Io, max
Line Regulation	-	0.3% Vo,set	-	Vin=Vin, min to Vin, max
Regulation Over Temperature (-40°C to +85°C)	-	0.3% Vo,set	-	Tref=Ta, min to Ta, max
Output Current	0 A	-	16 A	
Current Limit Threshold	-	180% Io,out	-	
Short Circuit Surge Transient	-	1 A ² s	3 A ² s	
Ripple and Noise (pk-pk)	-	50 mV	100 mV	Tested with 0-20 MHz, 10 uF tantalum capacitor & 1 uF ceramic capacitor at the output
Ripple and Noise (rms)	-	30 mV	45 mV	
Turn on Time	-	8 mS	20 mS	
Overshoot at Turn on	-	-	1% Vo,set	
Output Capacitance	0 uF	-	5000 uF	ESR ≥ 10 mohm
Transient Response				
50% ~ 100% Max Load	All	-	100 mV	di/dt=2.5 A/uS; Vin=12 V; and with 330 uF tantalum capacitors at the output
Settling Time		-	80 uS	
100% ~ 50% Max Load		-	100 mV	
Settling Time		-	80 uS	

Note: All specifications are typical at nominal input, full load at 25 °C unless otherwise stated.

NON-ISOLATED DC/DC CONVERTERS

8.3 Vdc - 14 Vdc Input

0.75 Vdc - 5.5 Vdc/16 A Output



General Specifications

Parameter	Min	Typ	Max	Notes
Efficiency				Measured at Vin=12 V, full load
Vo=5.0 V	-	94%	-	
Vo=3.3 V	-	92%	-	
Vo=2.5 V	-	90%	-	
Vo=1.8 V	-	88%	-	
Vo=1.5 V	-	87%	-	
Vo=1.2 V	-	85%	-	
Vo=0.75 V	-	78%	-	
Switching Frequency	250 kHz	280 kHz	310 kHz	
Over Temperature Shutdown ¹	-	130 °C	-	
Output Trim Range (Wide Trim)	0.7525 V	-	5.5 V	
Remote Sense Compensation	-	-	0.5 V	
MTBF	4,619,490 hours			Calculated Per Bell Core SR-332 (Io = 80% load; Vin=12 V; Vo=3.3 V; Ta = 25 °C)
Dimensions				
Inches (L x W x H)	2.0x 0.5 x 0.32			
Millimeters (L x W x H)	50.8 x 12.7 x 8.13			
Weight	-	7.1 g	-	

Notes: All specifications are typical at 25 °C unless otherwise stated.

1. The Tref temperature measurement location:

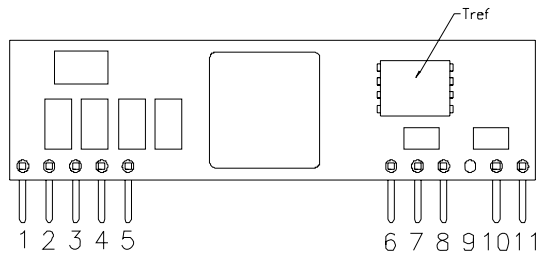

Control Specifications

Parameter	Min	Typ	Max	Notes
Remote On/Off				
Signal Low (Unit Off)	-0.2 V	-	0.3 V	VRBC-16A1A0; Remote On/Off pin open, Unit on.
Signal High (Unit On)	-	-	Vin, max	
Signal Low (Unit On)	-0.2 V	-	0.3 V	VRBC-16A1AL; Remote On/Off pin open, Unit on.
Signal High (Unit Off)	2.5 V	-	Vin, max	

NON-ISOLATED DC/DC CONVERTERS

8.3 Vdc - 14 Vdc Input

0.75 Vdc - 5.5 Vdc/16 A Output

bel
POWER PRODUCTS

Remote On/Off

For Active High Modules (Positive Logic)

When the transistor Q1 is in the Off state, the power module is ON.

When the transistor Q1 is turned On, the power module is OFF.

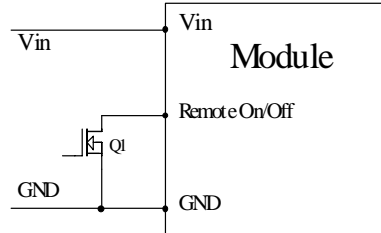

For Active Low Modules (Negative Logic)

When the transistor Q1 is in the Off state, the power module is OFF.

When the transistor Q1 is turned On, the power module is ON.

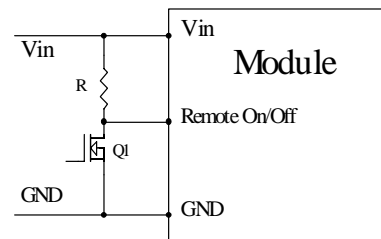

Output Trim Equations

Equation for calculating the trim resistor given the desired output voltage (V_o) is shown below. R_{trim} is the required resistance between the trim pin and GND pin, V_{trim} is the required voltage between the trim and GND pin.

$$R_{trim} = \left[\frac{10500}{V_o - 0.7525} - 1000 \right]$$

V_o (V)	R_{trim} (K Ω)
0.7525	Open
1.2	22.46
1.5	13.05
1.8	9.024
2.5	5.009
3.3	3.122
5.0	1.472

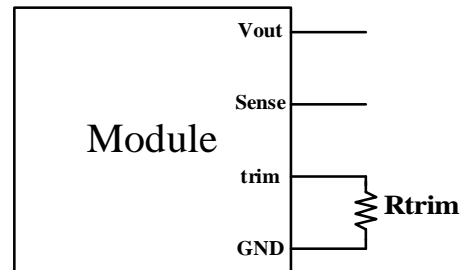

$$V_{trim} = \{0.7 - 0.0667 \times (V_o - 0.7525)\}$$

V_o (V)	V_{trim} (V)
0.7525	Open
1.2	0.67
1.5	0.65
1.8	0.63
2.5	0.583
3.3	0.53
5.0	0.42

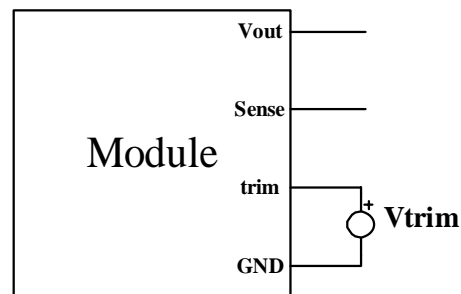

NON-ISOLATED DC/DC CONVERTERS

8.3 Vdc - 14 Vdc Input

0.75 Vdc - 5.5 Vdc/16 A Output



Efficiency Data

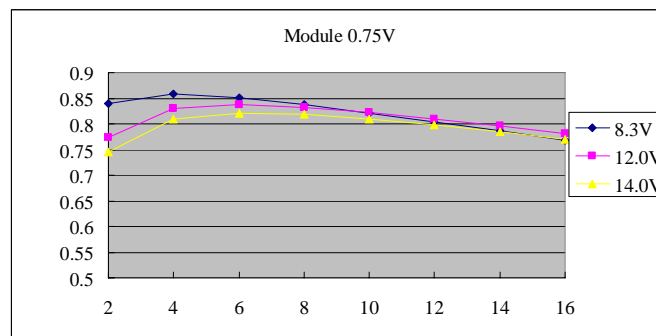
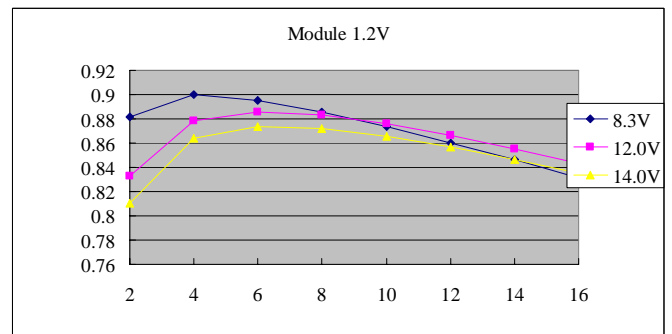
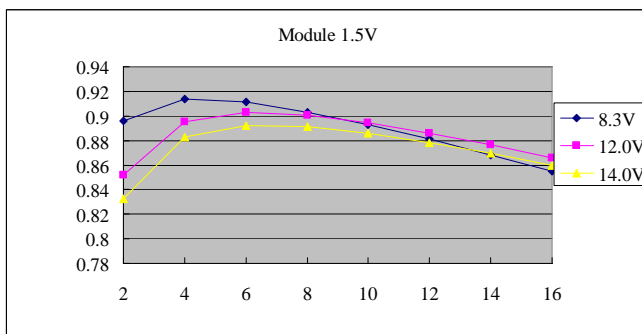
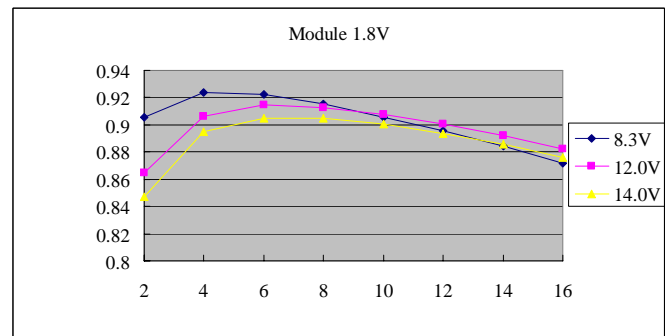
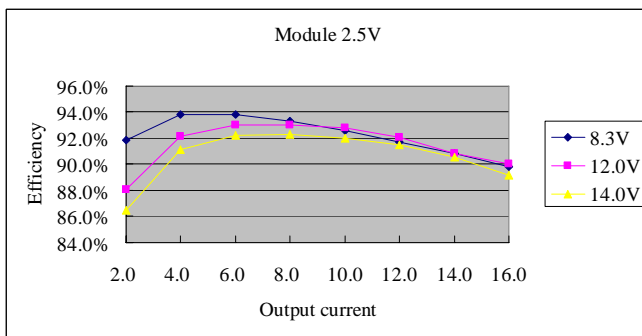
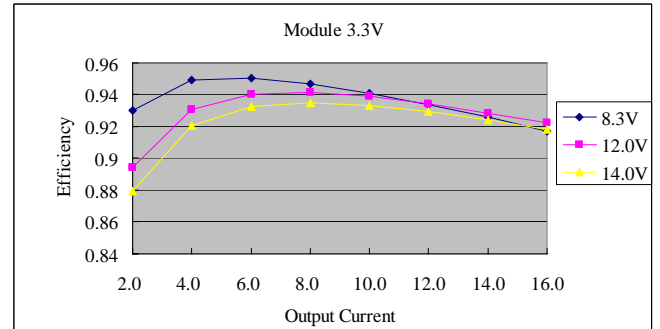
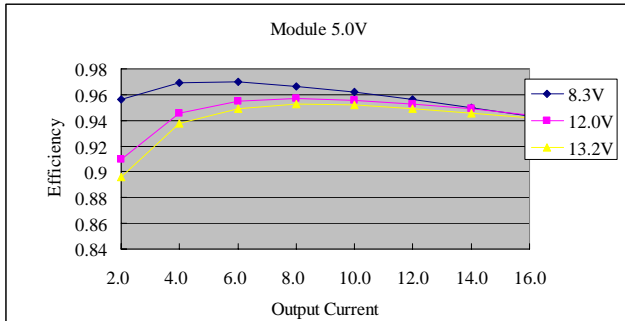

NON-ISOLATED DC/DC CONVERTERS

8.3 Vdc - 14 Vdc Input

0.75 Vdc - 5.5 Vdc/16 A Output



Thermal Derating Curves

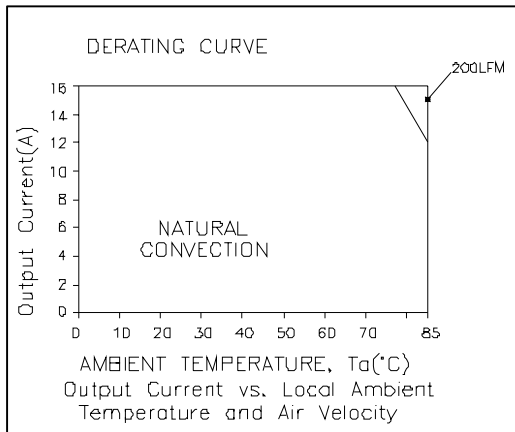

Vo=0.75 V; Vin=12.0 V

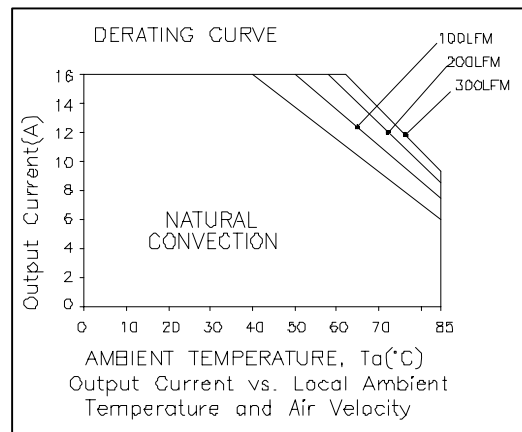

Vo=1.8 V; Vin=12.0 V

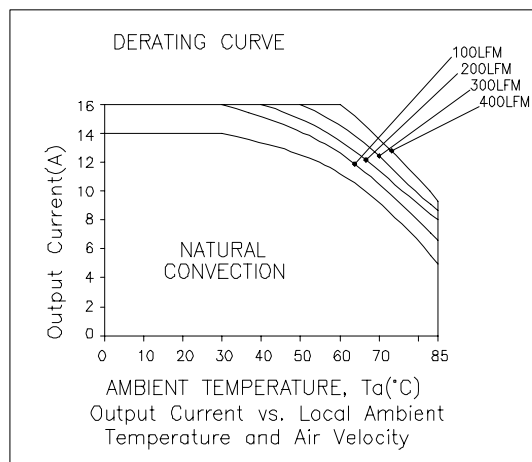

Vo=3.3 V; Vin=12.0 V

NON-ISOLATED DC/DC CONVERTERS

8.3 Vdc - 14 Vdc Input

0.75 Vdc - 5.5 Vdc/16 A Output



Ripple and Noise Waveforms

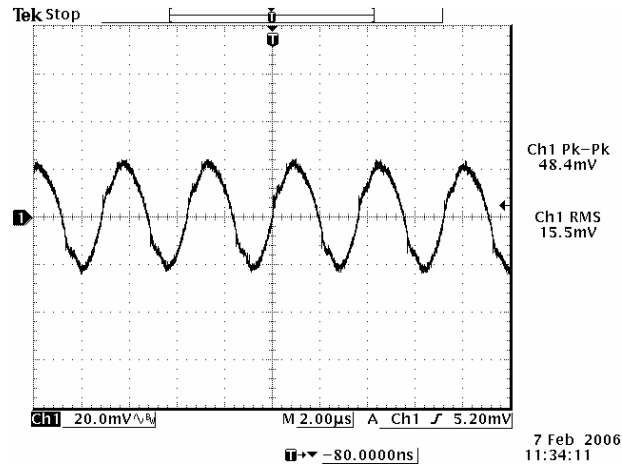

Ripple and noise at full load, 12 Vdc input, 5.0 Vdc output

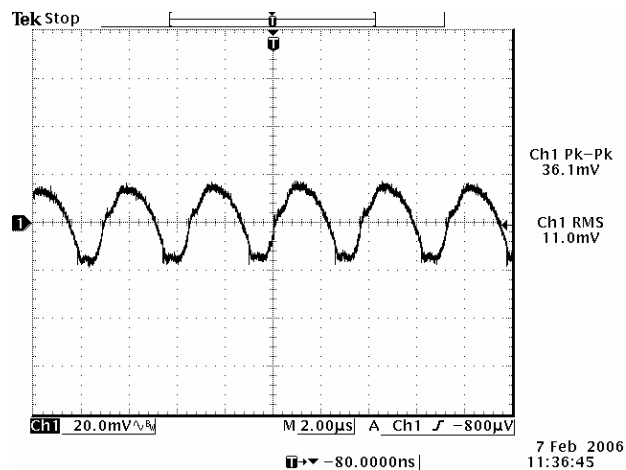

Ripple and noise at full load, 12 Vdc input, 3.3 Vdc output

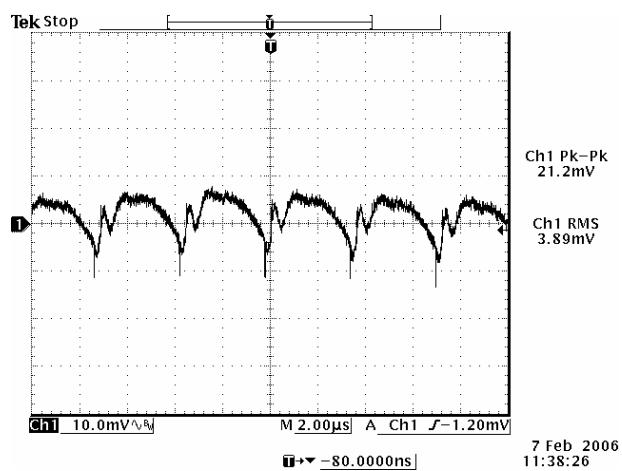

Ripple and noise at full load, 12 Vdc input, 0.75 Vdc output

Note: External load with 10uF tantalum capacitor and 1uF ceramic at the output, and $T_a=25$ deg C.

NON-ISOLATED DC/DC CONVERTERS

8.3 Vdc - 14 Vdc Input

0.75 Vdc - 5.5 Vdc/16 A Output



Transient Response Waveforms

External load capacitor $C_{ext}=0 \mu\text{F}$, $di/dt=2.5 \text{ A}/\mu\text{s}$

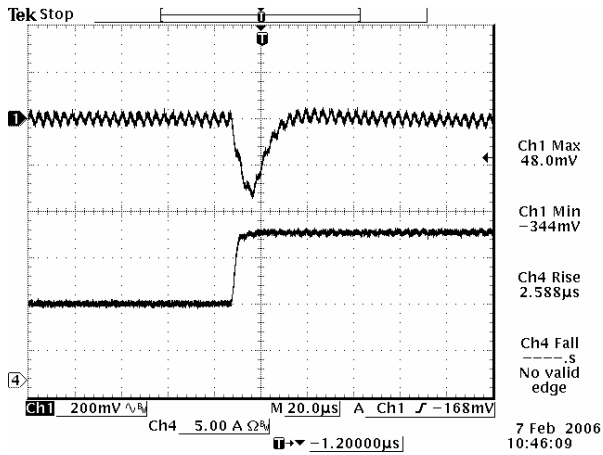

50% to 100% load Transient at 5.0 Vdc output

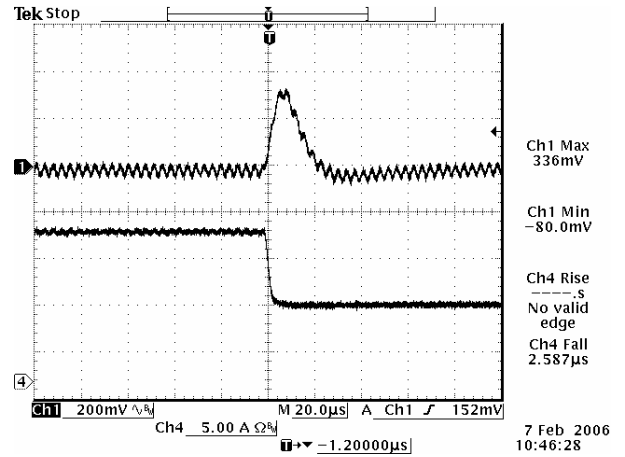

100% to 50% load Transient at 5.0 Vdc output

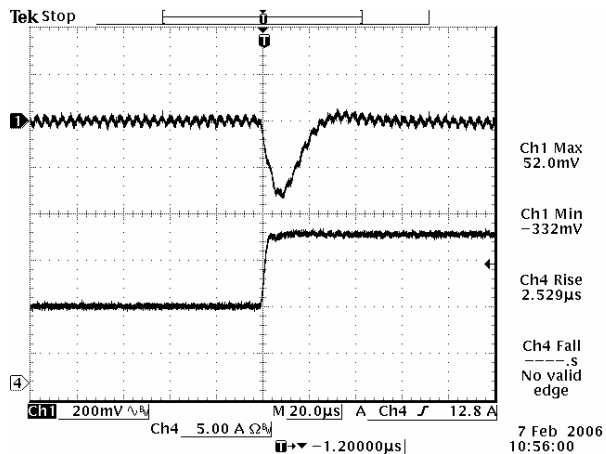

50% to 100% load Transient at 3.3 Vdc output

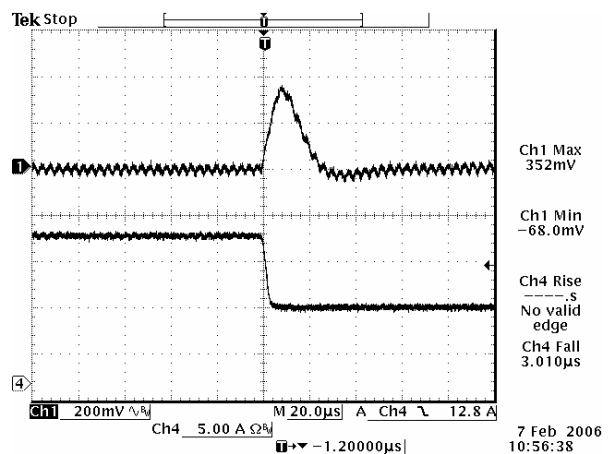

100% to 50% load Transient at 3.3 Vdc output

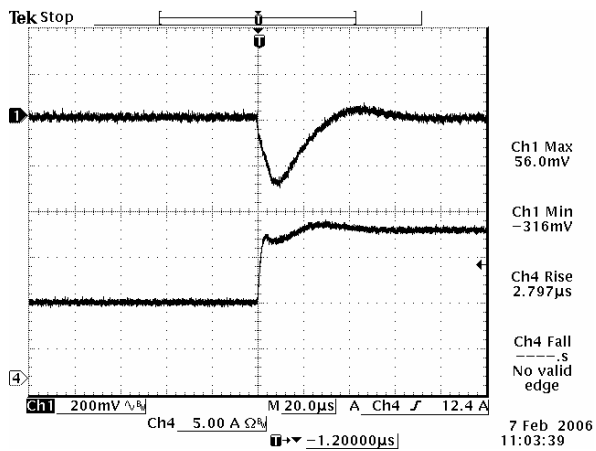

50% to 100% load Transient 0.75 Vdc output

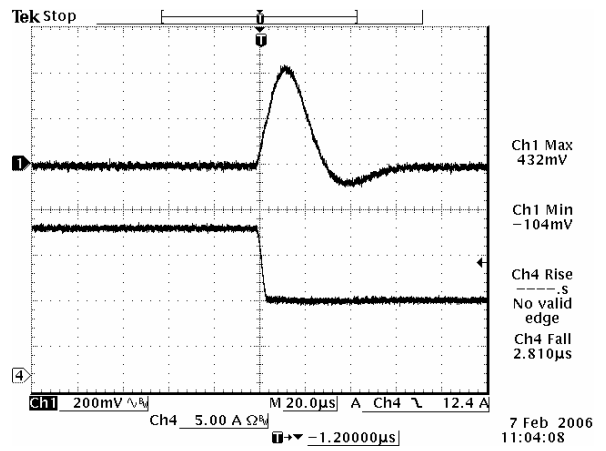

100% to 50% load Transient at 0.75 Vdc output

NON-ISOLATED DC/DC CONVERTERS

8.3 Vdc - 14 Vdc Input

0.75 Vdc - 5.5 Vdc/16 A Output



Transient Response (continued)

External load capacitor $C_{ext}=330 \mu\text{F}$ Tantalum capacitor, $di/dt=2.5 \text{ A/us}$

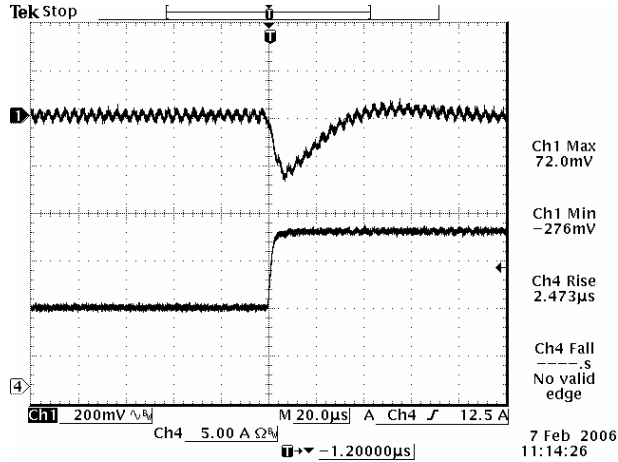

50% to 100% load Transient at 5.0 Vdc output

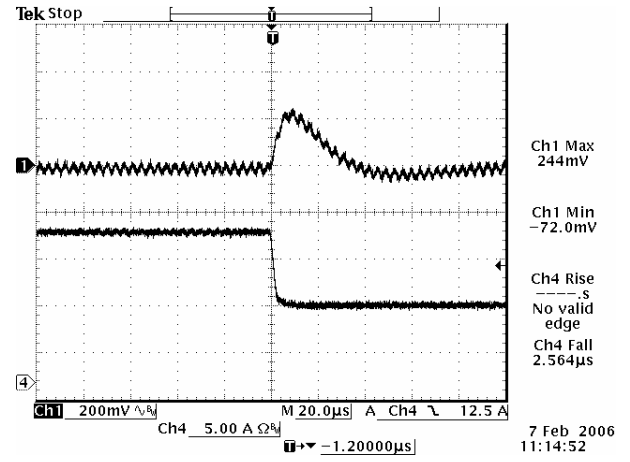

100% to 50% load Transient at 5.0 Vdc output

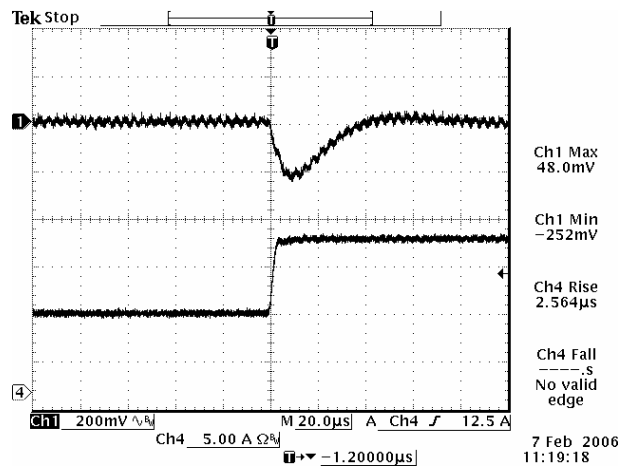

50% to 100% load Transient at 3.3 Vdc output

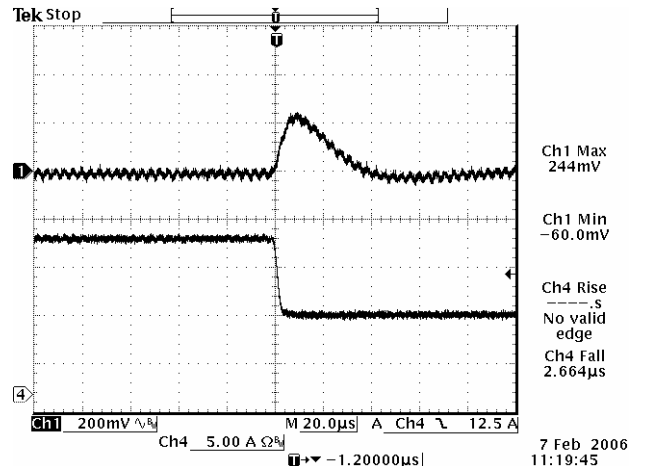

100% to 50% load Transient at 3.3 Vdc output

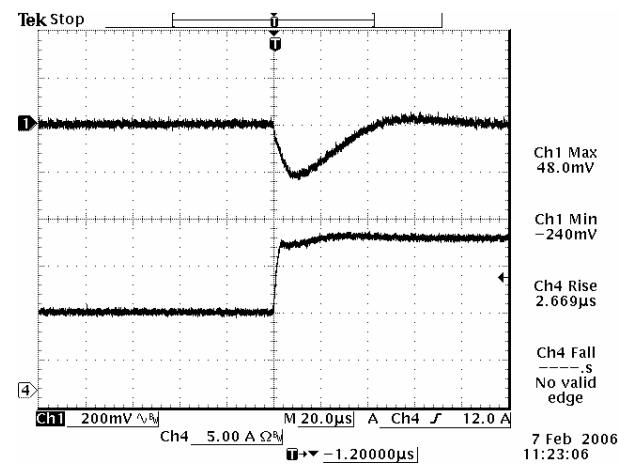

50% to 100% load Transient 0.75 Vdc output

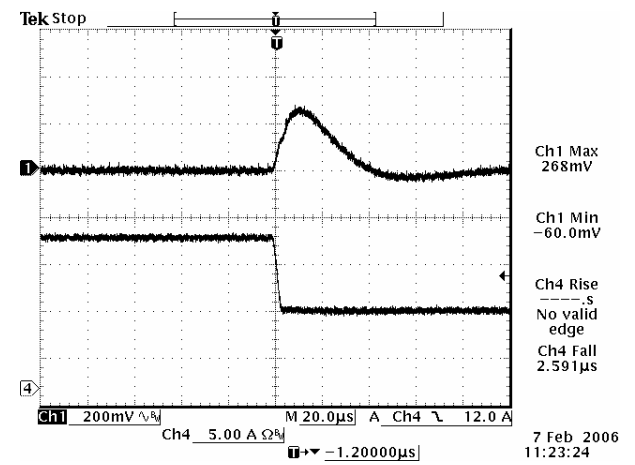

100% to 50% load Transient at 0.75 Vdc output

Note: All specifications are typical at 12Vdc input and $T_a=25 \text{ deg C}$.

NON-ISOLATED DC/DC CONVERTERS

8.3 Vdc - 14 Vdc Input

0.75 Vdc - 5.5 Vdc/16 A Output



Mechanical Outline

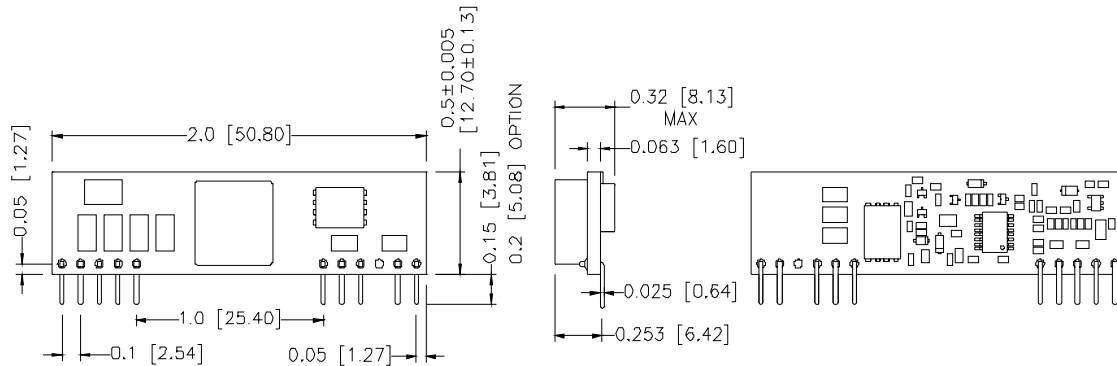

UNIT: INCH [MM]

TOP VIEW

SIDE VIEW

BACK VIEW

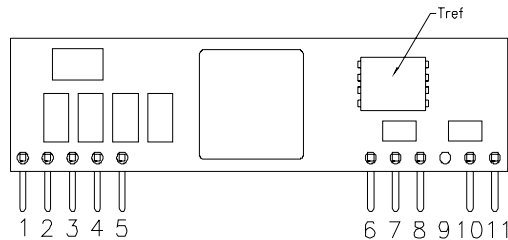

RECOMMENDED PAD LAYOUT

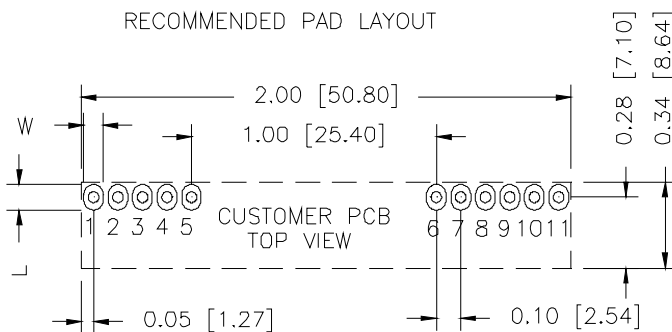

HOLE SIZE: $\varnothing 0.043 \pm 0.003$ [1.08 ± 0.08]
 PAD SIZE: W 0.063 ± 0.002 [1.63 ± 0.05]
 L 0.10 ± 0.004 [2.54 ± 0.10] BOTH SIDE

Pin Connections

Pin	Function
1	Vo
2	Vo
3	Sense+
4	Vo
5	Ground
6	Ground
7	Vin
8	Vin
9	N/A
10	Trim
11	Remote On/Off

RoHS Compliance

Complies with the European Directive 2002/95/EC, calling for the elimination of lead and other hazardous substances from electronic products.



©2007 Bel Fuse Inc. Specifications subject to change without notice. 011607

CORPORATE

Bel Fuse Inc.
 206 Van Vorst Street
 Jersey City, NJ 07302
 Tel 201-432-0463
 Fax 201-432-9542
www.belfuse.com

FAR EAST

Bel Fuse Ltd.
 8F/ 8 Luk Hop Street
 San Po Kong
 Kowloon, Hong Kong
 Tel 852-2328-5515
 Fax 852-2352-3706
www.belfuse.com

EUROPE

Bel Fuse Europe Ltd.
 Preston Technology Management Centre
 Marsh Lane, Suite G7, Preston
 Lancashire, PR1 8UD, U.K.
 Tel 44-1772-556601
 Fax 44-1772-888366
www.belfuse.com