

## NON-ISOLATED DC/DC CONVERTERS

4.5 Vdc - 13.8 Vdc Input    0.591 Vdc - 5.1 Vdc/20 A Output

**bel**  
POWER PRODUCTS

**VRP1-20E1A0**

**RoHS Compliant**

**Rev. G**

- Non-Isolated
- High Efficiency
- Fixed Switching Frequency
- Low Cost
- Excellent Thermal Performance
- Wide Input Voltage Range
- Wide Output Trim Range
- Output Over-Voltage Shutdown
- OCP/SCP
- Low Output Ripple
- Power Good Signal
- Remote On/Off

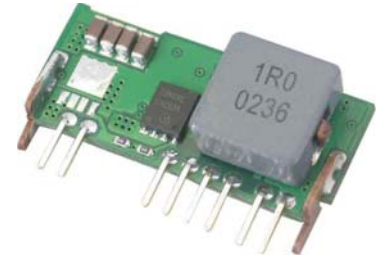

### Description

The VRP1-20E1A0 is a non-isolated dc/dc converter that operates over a wide range of input voltage ( $V_{in} = 4.5 \text{ Vdc} \sim 13.8 \text{ Vdc}$ ). This unit can provide a precisely regulated output voltage from 0.591 Vdc to 5.1 Vdc and can deliver up to 20 A of output current. This unit is designed to be highly efficient and low cost. The converter is provided in an industry standard package.

### Part Selection

Output Voltage	Input Voltage	Max. Output Current	Max. Output Power	Typical Efficiency ( $V_o=5.0 \text{ Vdc}$ )	Model Number Active High
0.591 Vdc - 5.1 Vdc	4.5 Vdc - 13.8 Vdc	20 A	100 W	94%	VRP1-20E1A0

**Notes:** 1. All part numbers above indicate RoHS 6. Change the second letter "R" to "7" for RoHS 5 part numbers.  
2. Add "G" suffix at the end of the model numbers listed above to indicate "Tray Packaging".

### Absolute Maximum Ratings

Parameter	Min	Typ	Max	Notes
Input Voltage (continuous)	-0.3 V	-	15 V	
Output Enable Terminal Voltage	-0.3 V	-	15 V	
Ambient Temperature	0 °C	-	70 °C	
Storage Temperature	-40 °C	-	125 °C	

### Input Specifications

Parameter	Min	Typ	Max	Notes
Input Voltage				
$V_o < 3.45 \text{ V}$	4.5 V	12 V	13.8 V	
$V_o \geq 3.45 \text{ V}$	$1.3 \cdot V_o$	12 V	13.8 V	
Input Current (full load)	-	-	20 A	An input line fuse must always be used.
Input Current (No load)	-	150 mA	300 mA	
Remote Off Input Current	-	50 mA	-	
Input Reflected Ripple Current (pk-pk)	-	50 mA	100 mA	Use a 1000uF AL-Cap on the input.
Input Reflected Ripple Current (rms)	-	20 mA	40 mA	
$I^2t$ Inrush Current Transient	-	-	$1 \text{ A}^2\text{s}$	
Turn-on Voltage Threshold	-	4.2 V	-	A 30.1K resistor is connected from Enable to Vin
Turn-off Voltage Threshold	-	3.9 V	-	

**Note:** All specifications are typical at 25 °C unless otherwise stated.

## NON-ISOLATED DC/DC CONVERTERS

4.5 Vdc - 13.8 Vdc Input    0.591 Vdc - 5.1 Vdc/20 A Output



### Output Specifications

Parameter	Min	Typ	Max	Notes	
Output Voltage Set Point Accuracy	-1.5 % Vo	-	+1.5 % Vo	Vin=12 V, Iout=half load	
Load Regulation	-	-	1% Vo		
Line Regulation	-	-	0.5% Vo		
Regulation Over Temperature (0 °C to +70 °C)	-	-	1% Vo		
Output Current	0 A	-	20 A		
Current Limit Threshold	-	150% Iomax	-		
Output Ripple and Noise (pk-pk)	-	40 mV	80 mV	Test conditions: 0-20MHz BW, with a 1µF ceramic capacitor and a 10uF Tantalum cap at output.	
Output Ripple and Noise (rms)	-	20 mV	40 mV		
Short Circuit Surge Transient	-	1 A <sup>2</sup> s	3 A <sup>2</sup> s		
Turn On Time	-	2 mS	10 mS		
Overshoot at Turn on and off	-	-	5%		
Output Capacitance	0 uF	-	1000 uF		
<b>Transient Response</b>					
50% ~ 75% Max Load	Vo=All	-	200 mV	300 mV	Test conditions: di/dt = 2.5 A/uS; Vin =12 V; with 10 uF tantalum cap and 1 uF ceramic at the output, Ta=25 °C
Settling Time		-	-	50 uS	
75% ~ 50% Max Load		-	200 mV	300 mV	
Settling Time		-	-	50 uS	

**Note:** All specifications are typical at 25 °C unless otherwise stated.

### General Specifications

Parameter	Min	Typ	Max	Notes
Efficiency Vo=5.0 V Vo=3.3 V Vo=2.5 V Vo=1.5 V Vo=0.591 V	- - - - -	94% 92% 90% 85% 70%	- - - - -	Measured at Vin=12 V, full load.
Switching Frequency	-	500 kHz	-	
Output Voltage Trim Range	0.591 V	-	5.1 V	
Remote Sense Compensation	-	-	0.2 V	Vin=12 V, Io=full load.
MTBF	TBD			Calculated Per Bell Core SR-332 (Io = 80%Iomax; Vin=12 V; Ta = 25 °C)
Dimensions Inches (L x W x H) Millimeters (L x W x H)	1.45 x 0.61 x 0.40 36.83 x 15.49 x 10.15			
Weight	-	9.7 g	-	

**Note:** All specifications are typical at 25 °C unless otherwise stated.

## NON-ISOLATED DC/DC CONVERTERS

4.5 Vdc - 13.8 Vdc Input    0.591 Vdc - 5.1 Vdc/20 A Output



### Control Specifications

Parameter	Min	Typ	Max	Notes
<b>Remote On/Off (Active High)</b>				
Signal Low (Unit Off)	-0.3 V	-	0.4 V	Remote On/Off pin is open, unit is off.
Signal High (Unit On)	2 V	-	5.5 V	
<b>PwGood (PowerGood)</b>				
PwGood = High = Power Good	2.4 V	-	6 V	
	-	-	2 mA	
PwGood = Low = Power Not Good	0 V	-	0.35 V	
	-	-	5 mA	

### Output Trim Equation

The Rtrim resistor should be connected between the Trim pin and GND pin.

$$R_{trim} = \left[ \frac{1.182}{V_o - 0.591} \right] \text{ k}\Omega$$

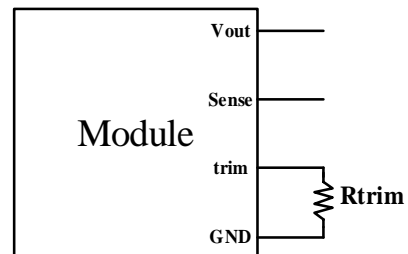

# NON-ISOLATED DC/DC CONVERTERS

4.5 Vdc - 13.8 Vdc Input 0.591 Vdc - 5.1 Vdc/20 A Output



## Efficiency Data

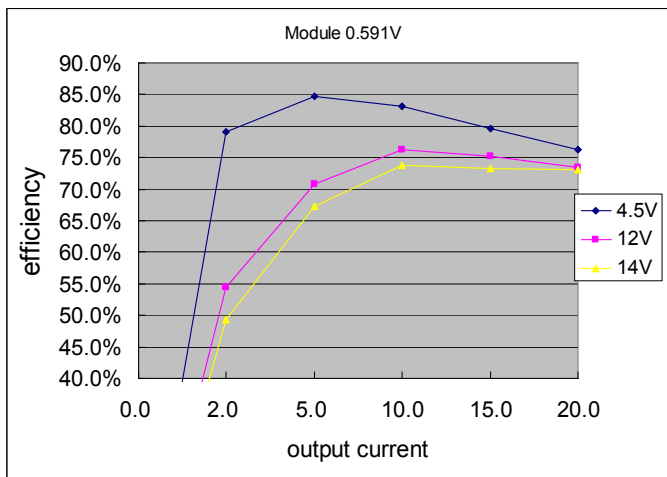
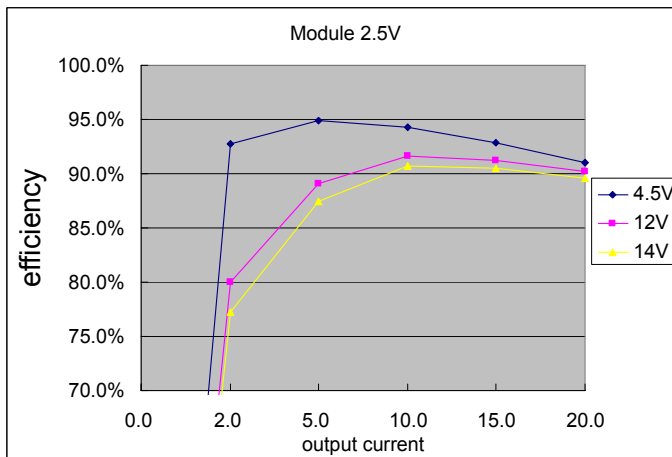
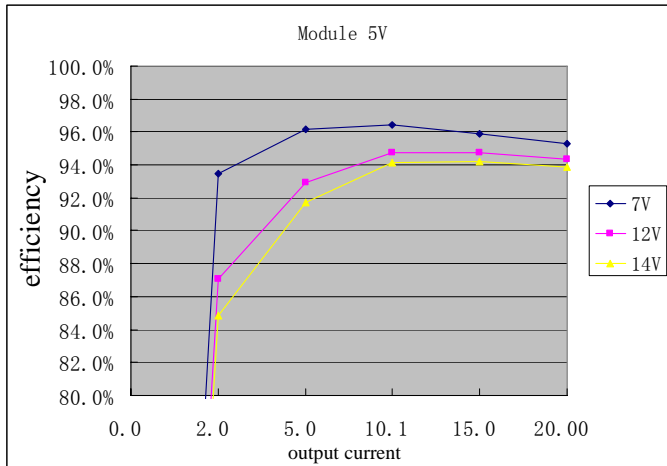

# NON-ISOLATED DC/DC CONVERTERS

4.5 Vdc - 13.8 Vdc Input    0.591 Vdc - 5.1 Vdc/20 A Output



## Thermal Derating Curves

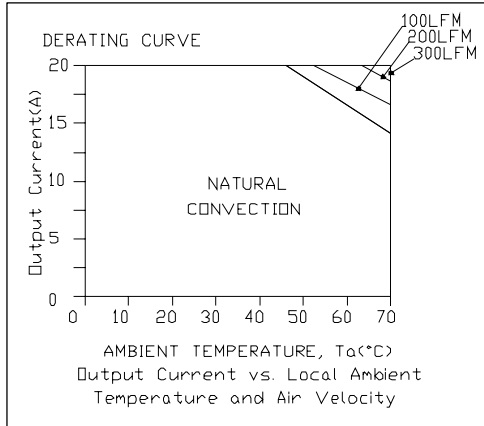

Vout=0.591V

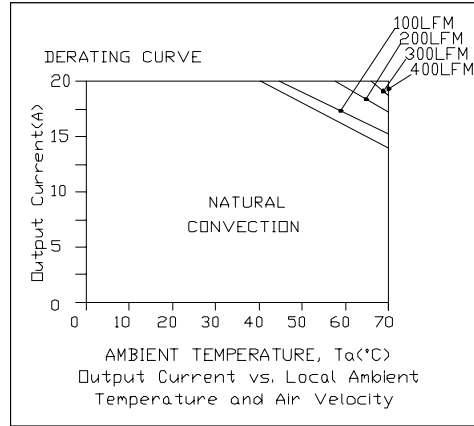

Vout=1.2 V

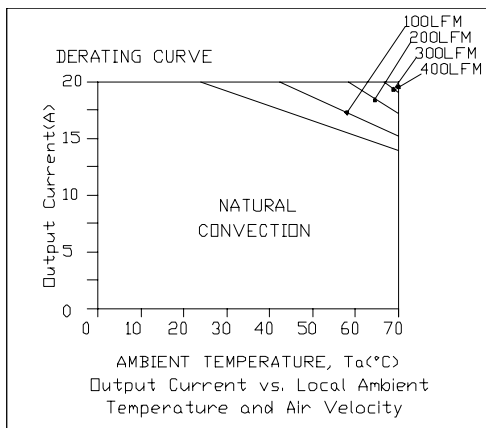

Vout=2.5 V

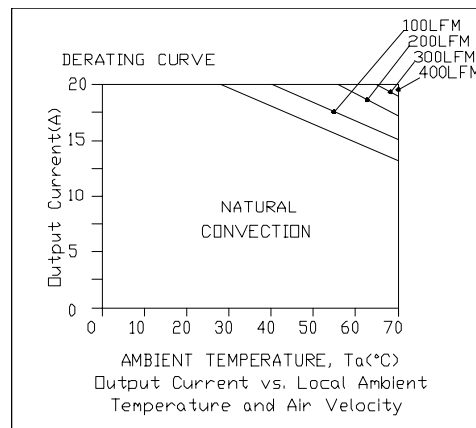

Vout=3.3 V

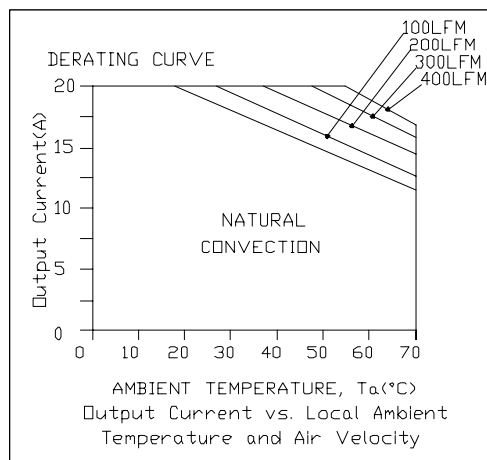

Vout=5 V

# NON-ISOLATED DC/DC CONVERTERS

4.5 Vdc - 13.8 Vdc Input    0.591 Vdc - 5.1 Vdc/20 A Output



## Ripple and Noise Waveforms

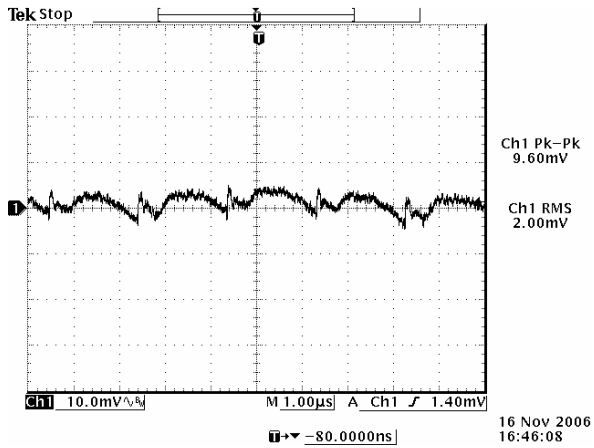

12 Vdc input, 0.591 Vdc output

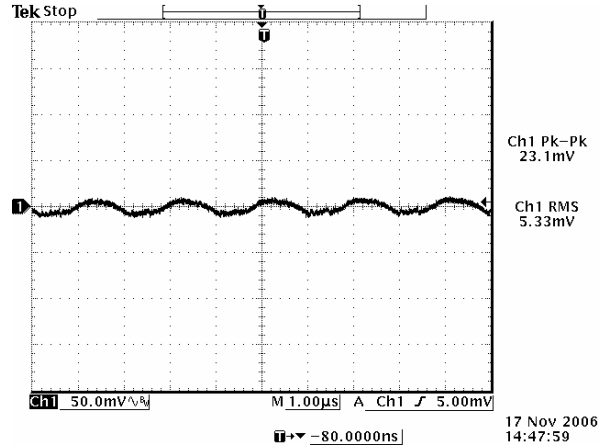

12 Vdc input, 2.5 Vdc output

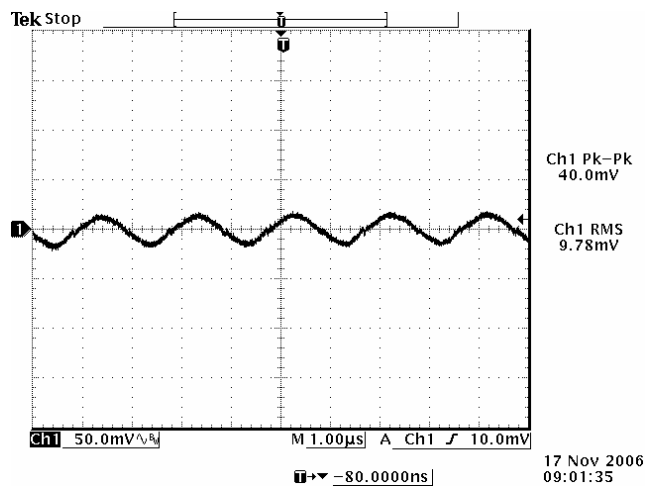

12 Vdc input, 5 Vdc output

**Note:** Ripple and noise at full load, 0-20 MHz BW, with a 10 uF tantalum cap and a 1 uF ceramic cap, and Ta=25 deg C.

# NON-ISOLATED DC/DC CONVERTERS

4.5 Vdc - 13.8 Vdc Input    0.591 Vdc - 5.1 Vdc/20 A Output



## Transient Response Waveforms

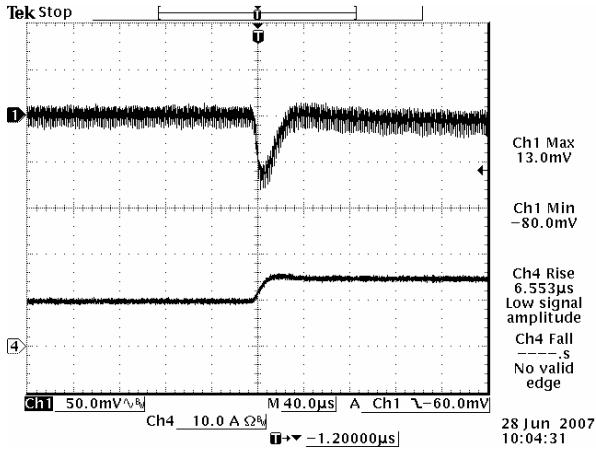

Vout= 2.5 V 50%-75% Load Transients

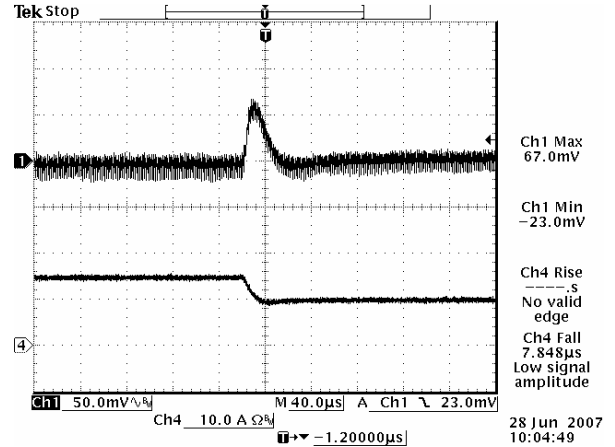

Vout=2.5 V 75%-50% Load Transients

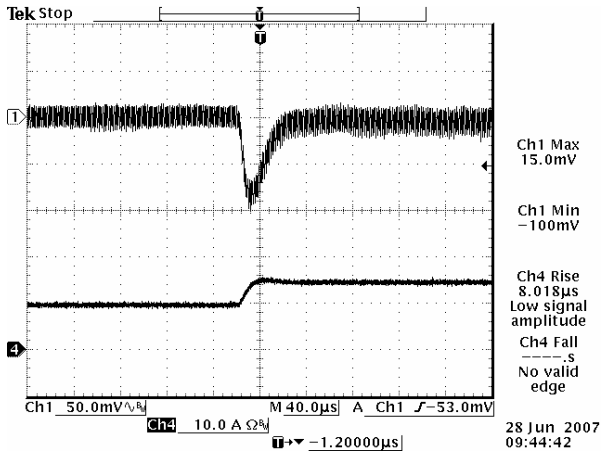

Vout= 5 V 50%-75% Load Transients

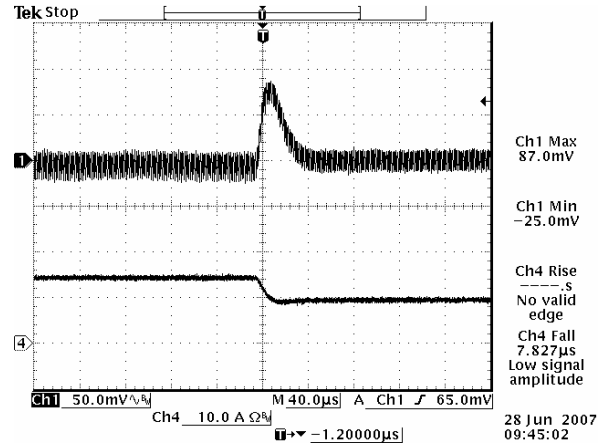

Vout=5 V 75%-50% Load Transients

**Note:** Transient response at  $di/dt = 2.5 \text{ A}/\mu\text{S}$ , with 1  $\mu\text{F}$  ceramic capacitor at the output, and  $T_a=25 \text{ deg C}$ .

# NON-ISOLATED DC/DC CONVERTERS

4.5 Vdc - 13.8 Vdc Input    0.591 Vdc - 5.1 Vdc/20 A Output



## Mechanical Outline

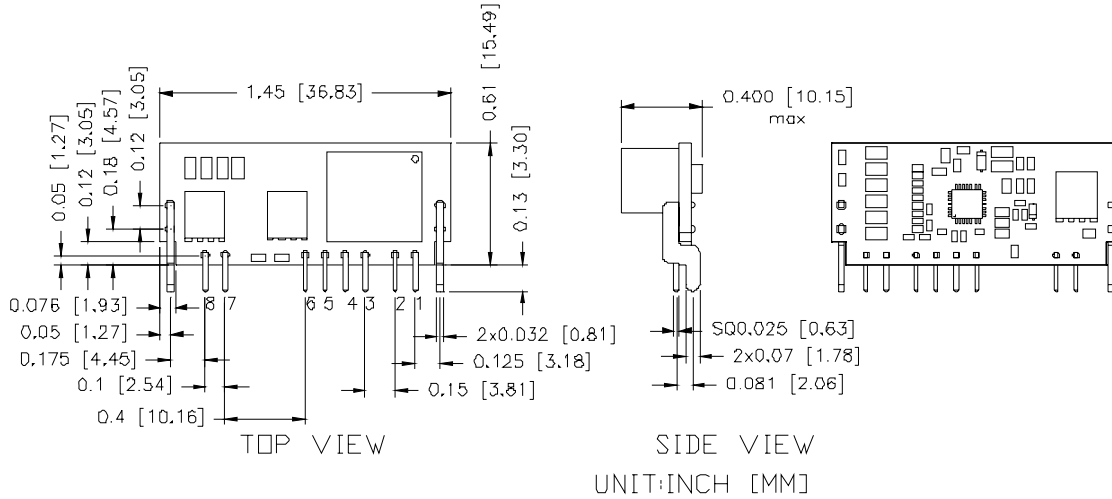

## RECOMMENDED PCB LAYOUT

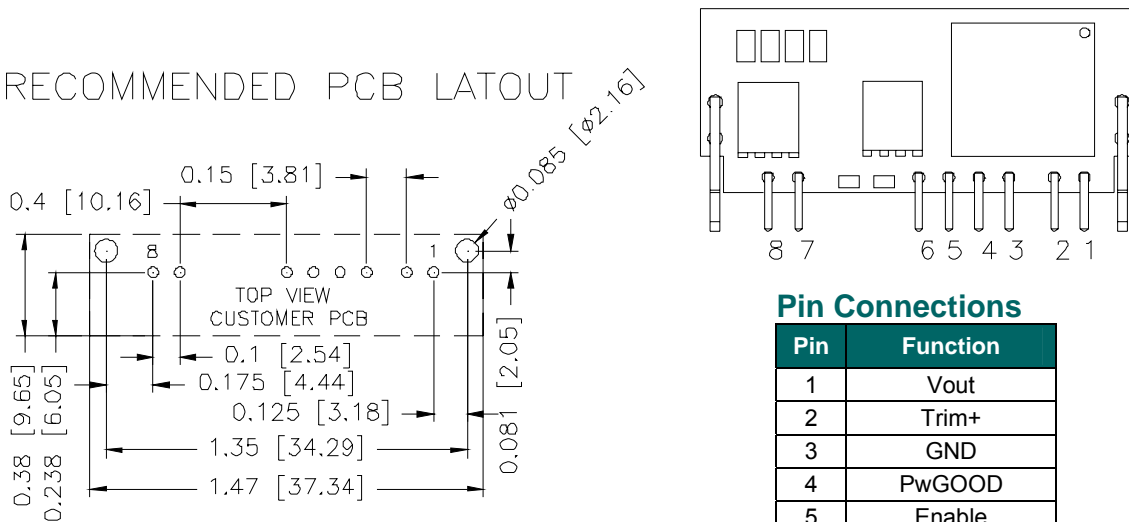

2 SUPPORT PAD HOLES:  $\phi 0.085$  [2.16] BOTH SIDES  
 8 PIN PAD HOLES:  $\phi 0.04$  [1.00] BOTH SIDES

## Pin Connections

Pin	Function
1	Vout
2	Trim+
3	GND
4	PwGOOD
5	Enable
6	Vin
7	Sense+
8	Sense-

## RoHS Compliance

Complies with the European Directive 2002/95/EC, calling for the elimination of lead and other hazardous substances from electronic products.



©2008 Bel Fuse Inc. Specifications subject to change without notice. 030308

### CORPORATE

**Bel Fuse Inc.**  
 206 Van Vorst Street  
 Jersey City, NJ 07302  
 Tel 201-432-0463  
 Fax 201-432-9542  
[www.belfuse.com](http://www.belfuse.com)

### FAR EAST

**Bel Fuse Ltd.**  
 8F/ 8 Luk Hop Street  
 San Po Kong  
 Kowloon, Hong Kong  
 Tel 852-2328-5515  
 Fax 852-2352-3706  
[www.belfuse.com](http://www.belfuse.com)

### EUROPE

**Bel Fuse Europe Ltd.**  
 Preston Technology Management Centre  
 Marsh Lane, Suite G7, Preston  
 Lancashire, PR1 8UD, U.K.  
 Tel 44-1772-556601  
 Fax 44-1772-888366  
[www.belfuse.com](http://www.belfuse.com)