

NON-ISOLATED DC/DC CONVERTERS

3.3 Vdc Input

0.9 Vdc - 2.5 Vdc/15 A Output

bel
POWER PRODUCTS

VRPB-15C Series

RoHS Compliant

Rev.A

- Non-Isolated
- High Efficiency
- High Power Density
- Fixed Frequency (300 kHz)
- Low Cost
- Remote On/Off
- Industry Standard Footprint
- Over Temperature Protection
- Under-voltage Lockout (UVLO)
- OCP/SCP
- Industrial Temperature Range
- Remote Sense
- Active Low/High (Option)

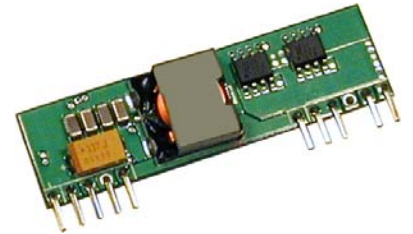

Description

The Bel VRPB-15Cxxx is part of the low cost non-isolated dc/dc converter series. The modules use a SIP package for ease of layout and space savings. The output is closely regulated and the efficiency is typically 93% at 2.5 Vdc output at full load. Typical features include remote on/off, under-voltage lockout, over-current protection and short circuit protection.

Part Selection

Output Voltage	Input Voltage	Max. Output Current	Max. Output Power	Typical Efficiency	Model Number Active Low	Model Number Active High
2.5 Vdc	3.3 Vdc	15 A	37.5 W	93%	VRPB-15C25L	VRPB-15C25S
1.8 Vdc	3.3 Vdc	15 A	27.0 W	90%	VRPB-15C18L	VRPB-15C18S
1.5 Vdc	3.3 Vdc	15 A	22.5 W	89%	VRPB-15C15L	VRPB-15C15S
1.2 Vdc	3.3 Vdc	15 A	18.0 W	86%	VRPB-15C12L	VRPB-15C12S
0.9 Vdc	3.3 Vdc	15 A	13.5 W	83%	VRPB-15C09L	VRPB-15C09S

- Notes:** 1. All part numbers above indicate RoHS 6. Change the second letter "R" to "7" for RoHS 5 part numbers.
2. Add "0" suffix at the end of the model number to indicate "Tube Packaging", and "R" for "Reel Packaging", and "G" for "Tray Packaging".

Absolute Maximum Ratings

Parameter	Min	Typ	Max	Notes
Input Voltage (continuous)	-0.3 V	-	4 V	
Output Enable Terminal Voltage	-0.3 V	-	6 V	
Ambient Temperature	-40 °C	-	85 °C	
Storage Temperature	-55 °C	-	125 °C	

Input Specifications

Parameter	Min	Typ	Max	Notes
Input Voltage	3 V	3.3 V	3.6 V	
Input Current (full load)				
Vo=2.5 V	-	-	15 A	
Vo=1.8 V	-	-	11.5 A	
Vo=1.5 V	-	-	9.5 A	
Vo=1.2 V	-	-	8 A	
Vo=0.9 V	-	-	6 A	
Input Current (no load)				
Vo=2.5 V	-	120 mA	200 mA	
Vo=1.8 V	-	140 mA	200 mA	
Vo=1.5 V	-	160 mA	200 mA	
Vo=1.2 V	-	170 mA	200 mA	
Vo=0.9 V	-	180 mA	200 mA	

NON-ISOLATED DC/DC CONVERTERS

3.3 Vdc Input

0.9 Vdc - 2.5 Vdc/15 A Output



Input Specifications (continued)

Parameter	Min	Typ	Max	Notes
Remote Off Input Current				
Vo=2.5 V	-	12 mA	20 mA	
Vo=1.8 V	-	12 mA	20 mA	
Vo=1.5 V	-	17 mA	20 mA	
Vo=1.2 V	-	15 mA	20 mA	
Vo=0.9 V	-	15 mA	20 mA	
Input Reflected Ripple Current (pk-pk)				
Vo=2.5 V	-	80 mA	120 mA	Tested with simulated source impedance of 500nH and two 270uF/16V (P/N: 16SP270M SANYO) Oscon Capacitors at the input
Vo=1.8 V	-	110 mA	160 mA	
Vo=1.5 V	-	130 mA	180 mA	
Vo=1.2 V	-	100 mA	150 mA	
Vo=0.9 V	-	85 mA	135 mA	
Input Reflected Ripple Current (rms)				
Vo=2.5 V	-	25 mA	40 mA	Tested with simulated source impedance of 500nH and two 270uF/16V (P/N: 16SP270M SANYO) Oscon Capacitors at the input
Vo=1.8 V	-	30 mA	50 mA	
Vo=1.5 V	-	40 mA	60 mA	
Vo=1.2 V	-	30 mA	50 mA	
Vo=0.9 V	-	25 mA	40 mA	
I ² t Inrush Current Transient				
Vo=2.5 V	-	0.02 A ² s	0.04 A ² s	
Vo=1.8 V	-	0.015 A ² s	0.03 A ² s	
Vo=1.5 V	-	0.01 A ² s	0.02 A ² s	
Vo=1.2 V	-	0.008 A ² s	0.016 A ² s	
Vo=0.9 V	-	0.008 A ² s	0.016 A ² s	
Turn-on Voltage Threshold	-	2.8 V	-	
Turn-off Voltage Threshold	-	2.5 V	-	

Output Specifications

Parameter	Min	Typ	Max	Notes
Output Voltage Set Point				
Vo=2.5 V	2.450 V	2.5 V	2.550 V	Test condition: Vin=3.3 V, Iout=full load
Vo=1.8 V	1.764 V	1.8 V	1.836 V	
Vo=1.5 V	1.470 V	1.5 V	1.530 V	
Vo=1.2 V	1.176 V	1.2 V	1.224 V	
Vo=0.9 V	0.882 V	0.9 V	0.918 V	
Load Regulation				
Vo=2.5 V	-	6 mV	12.5 mV	
Vo=1.8 V	-	5 mV	9.0 mV	
Vo=1.5 V	-	4 mV	7.5 mV	
Vo=1.2 V	-	3 mV	6.0 mV	
Vo=0.9 V	-	3 mV	6.0 mV	
Line Regulation				
Vo=2.5 V	-	4 mV	7.5 mV	
Vo=1.8 V	-	3 mV	5.5 mV	
Vo=1.5 V	-	3 mV	4.5 mV	
Vo=1.2 V	-	2 mV	4.0 mV	
Vo=0.9 V	-	2 mV	4.0 mV	
Regulation Over Temperature (-40°C to +85 °C)				
Vo=2.5 V	-	30 mV	50 mV	
Vo=1.8 V	-	20 mV	40 mV	
Vo=1.5 V	-	15 mV	30 mV	
Vo=1.2 V	-	15 mV	25 mV	
Vo=0.9 V	-	10 mV	20 mV	

NON-ISOLATED DC/DC CONVERTERS

3.3 Vdc Input

0.9 Vdc - 2.5 Vdc/15 A Output



Output Specifications (continued)

Parameter	Min	Typ	Max	Notes	
Output Current	0 A	-	15 A		
Current Limit Threshold	18 A	-	35 A		
Short Circuit Surge Transient	-	0.2 A ² s	0.4 A ² s		
Turn on Time	-	6 mS	10 mS		
Overshoot at Turn on	-	0%	3%		
Output Capacitance	-	-	6800 uF		
Output Ripple and Noise (pk-pk)				Test conditions: 0-20 MHz BW; 0.1 uF ceramic capacitor and 10 uF aluminum capacitor at the output	
Vo=2.5 V	-	20 mV	50 mV		
Vo=1.8 V	-	25 mV	50 mV		
Vo=1.5 V	-	30 mV	60 mV		
Vo=1.2 V	-	25 mV	50 mV		
Vo=0.9 V	-	20 mV	50 mV		
Output Ripple and Noise (rms)					
Vo=2.5 V	-	5 mV	10 mV		
Vo=1.8 V	-	7 mV	10 mV		
Vo=1.5 V	-	8 mV	12 mV		
Vo=1.2 V	-	6 mV	10 mV		
Vo=0.9 V	-	5 mV	10 mV		
Transient Response					
50% ~ 100% Max Load	Vo=2.5 V	-	110 mV	150 mV	Test conditions: di/dt = 0.5 A/uS; Vin = 3.3 V; and with two 220 uF Tantalum capacitor at the output
Settling Time		-	40 uS	80 uS	
100% ~ 50% Max Load	Vo=1.8 V	-	110 mV	150 mV	
Settling Time		-	40 uS	80 uS	
50% ~ 100% Max Load	Vo=1.5 V	-	100 mV	130 mV	
Settling Time		-	40 uS	80 uS	
100% ~ 50% Max Load	Vo=1.2 V	-	100 mV	130 mV	
Settling Time		-	40 uS	80 uS	
50% ~ 100% Max Load	Vo=0.9 V	-	90 mV	120 mV	
Settling Time		-	40 uS	80 uS	
100% ~ 50% Max Load		-	90 mV	120 mV	
Settling Time		-	40 uS	80 uS	

Note: All specifications are typical at 25 °C unless otherwise stated.

NON-ISOLATED DC/DC CONVERTERS

3.3 Vdc Input 0.9 Vdc - 2.5 Vdc/15 A Output



General Specifications

Parameter	Min	Typ	Max	Notes
Efficiency				Measured at Vin=3.3 V, full load.
Vo=2.5 V	91%	93%	-	
Vo=1.8 V	88%	90%	-	
Vo=1.5 V	87%	89%	-	
Vo=1.2 V	84%	86%	-	
Vo=0.9 V	80%	83%	-	
Switching Frequency	250 kHz	300 kHz	340 kHz	
Output Voltage Trim Range				The total output adjust range will not be higher than 105% Vo for 2.5 V module, and 110% Vo for other modules.
Vo=2.5 V	90% Vo	-	105% Vo	
Vo=0.9 V-1.8 V	90% Vo	-	110% Vo	
Remote Sense Compensation				
Vo=2.5 V	-	-	5% Vo	
Vo=0.9 V-1.8 V	-	-	10% Vo	
MTBF	4,163,010 hours			Calculated Per Bell Core SR-332 (Vin=3.3 V, Io = 12 A; Ta = 25 °C)
Dimensions				
Inches (L x W x H)	2.0 x 0.55 x 0.387			
Millimeters (L x W x H)	50.8 x 13.97 x 9.84			
Weight	-	9.2 g	-	

Note: All specifications are typical at 25 °C unless otherwise stated.

Control Specifications

Parameter	Min	Typ	Max	Notes
Remote On/Off				
Signal Low (Unit Off)	-0.3 V	-	0.8 V	VRPB-15CxxS
Signal High (Unit On)	2.5 V	-	5.5 V	
Signal Low (Unit On)	-0.3 V	-	0.8 V	VRPB-15CxxL
Signal High (Unit Off)	2.5 V	-	5.5 V	

Output Trim Equations

Equations for calculating the trim resistor (in kΩ) given the desired adjusted voltage (Vadj) and the nominal output voltage of the converter (Vnom) are shown below. The Trim Down resistor should be connected between the Trim pin and Vout. The Trim Up resistor should be connected between the Trim pin and Ground. Only one of the resistors should be used for any given application.

$$R_{trim_down} = \frac{A(V_{adj} - 0.8)}{V_{nom} - V_{adj}} - B$$

$$R_{trim_up} = \frac{C}{V_{adj} - V_{nom}} - D$$

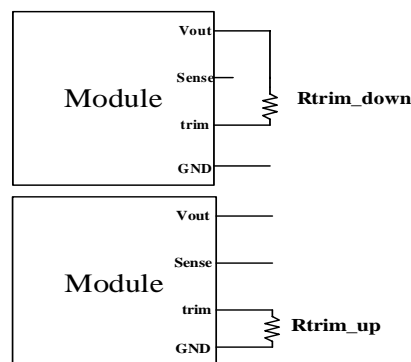

Vnom	A	B	C	D
2.5 V	2.370	4.990	1.896	4.990
1.8 V	2.370	4.990	1.896	4.990
1.5 V	2.370	4.990	1.896	4.990
1.2 V	2.490	2.370	1.992	2.370
0.9 V	1.050	0.010	0.840	0.010

NON-ISOLATED DC/DC CONVERTERS

3.3 Vdc Input

0.9 Vdc - 2.5 Vdc/15 A Output



Efficiency Data

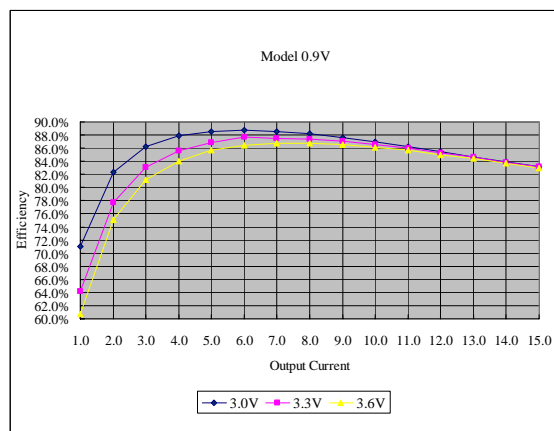
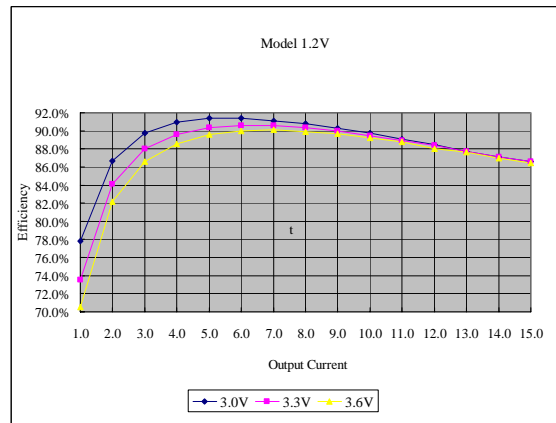
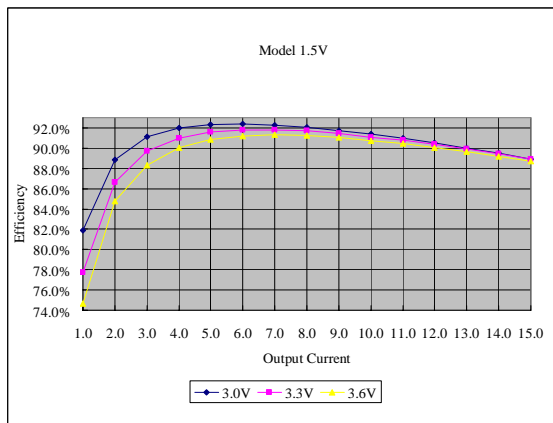
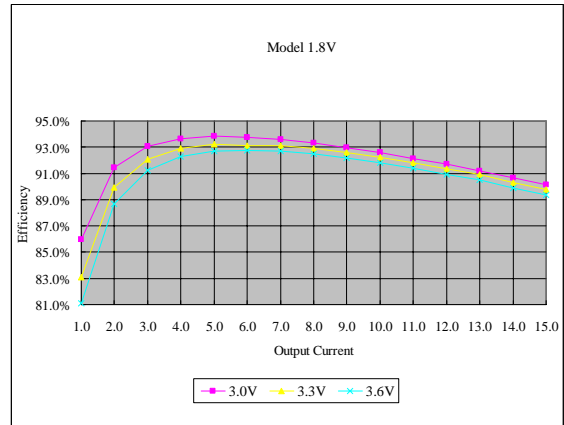
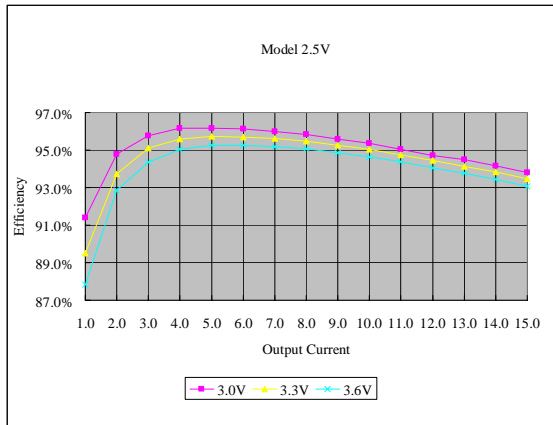

NON-ISOLATED DC/DC CONVERTERS

3.3 Vdc Input

0.9 Vdc - 2.5 Vdc/15 A Output



Thermal Derating Curve

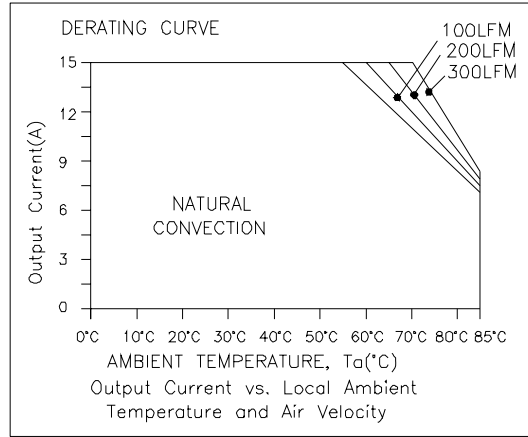

VRPB-15Cxxx

Transient Response Waveforms

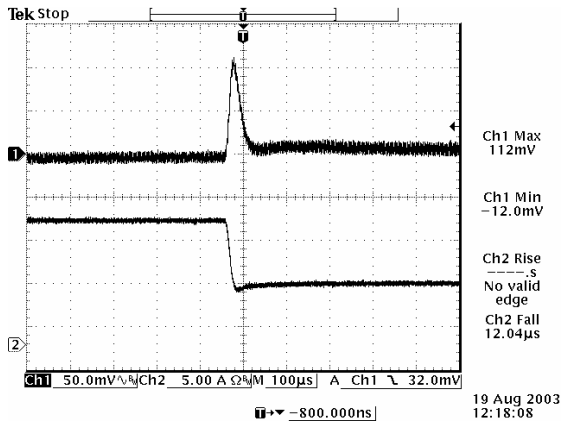

Vout=2.5 V 100% to 50% Load Transients

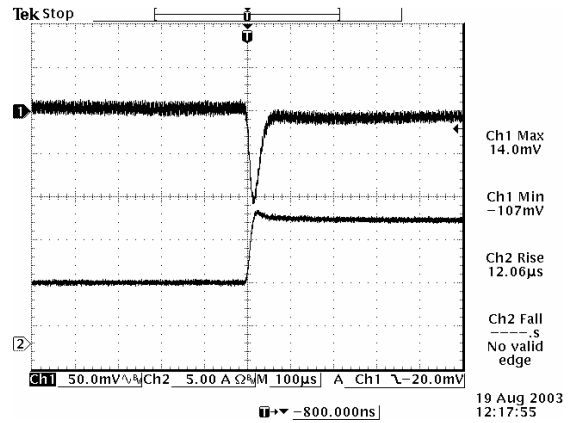

Vout=2.5 V 50% to 100% Load Transients

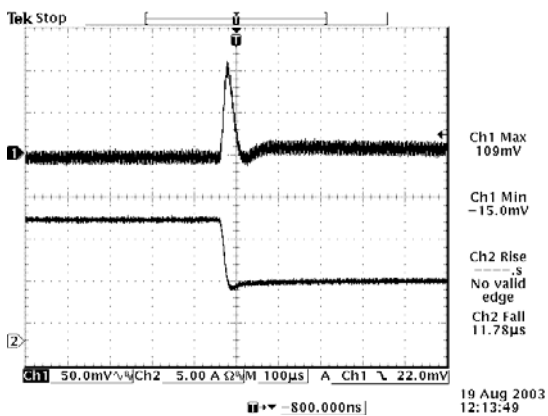

Vout=1.8 V 100% to 50% Load Transients

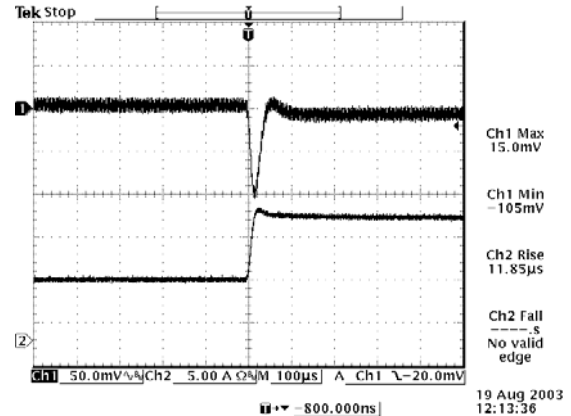

Vout=1.8 V 50% to 100% Load Transients

NON-ISOLATED DC/DC CONVERTERS

3.3 Vdc Input

0.9 Vdc - 2.5 Vdc/15 A Output



Transient Response Waveforms (continued)

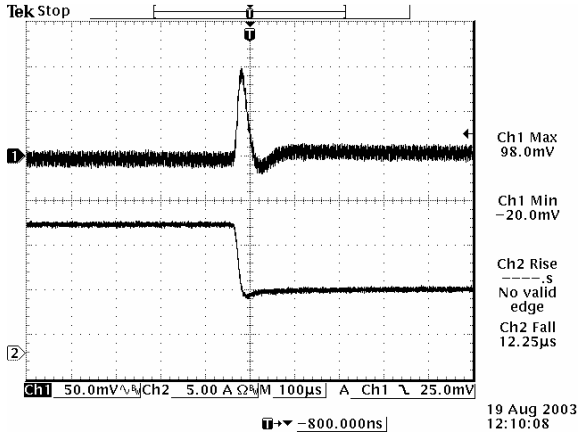

Vout=1.5 V 100% to 50% Load Transients

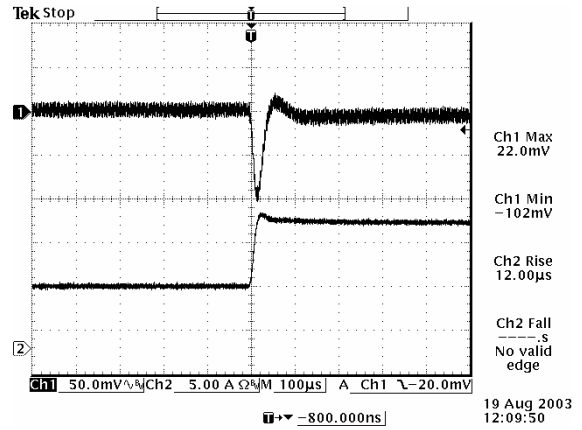

Vout=1.5 V 50% to 100% Load Transients

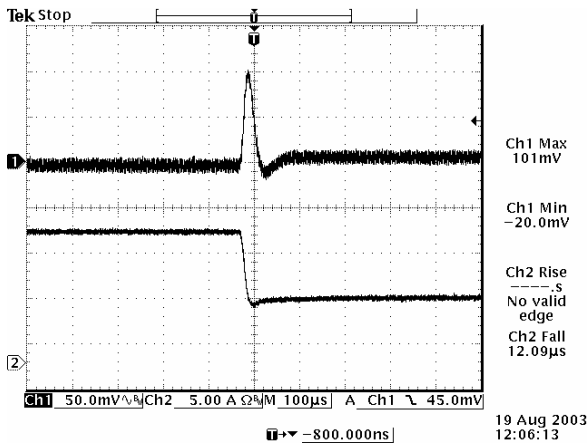

Vout=1.2 V 100% to 50% Load Transients

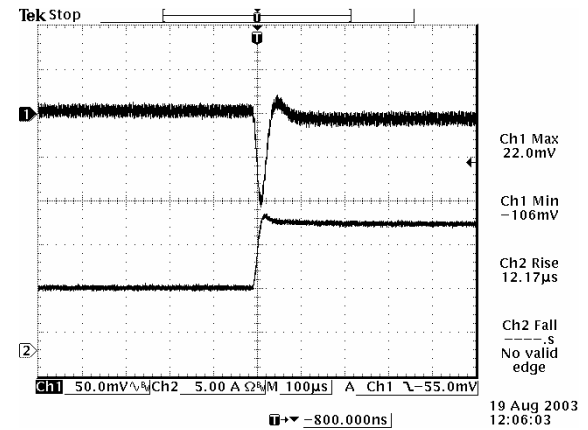

Vout=1.2 V 50% to 100% Load Transients

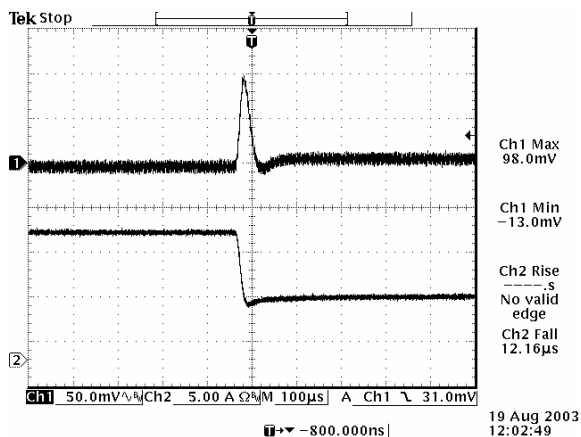

Vout=0.9 V 100% to 50% Load Transients

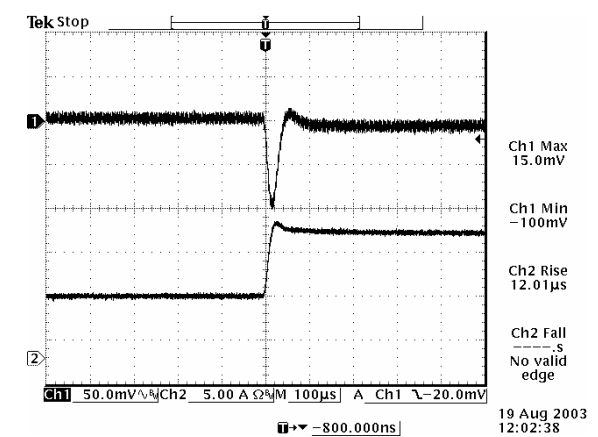

Vout=0.9 V 50% to 100% Load Transients

Note: Transient response at $di/dt=0.5 \text{ A}/\mu\text{s}$, $V_{in}=3.3 \text{ Vdc}$, $T_a=25^\circ \text{C}$, with two 220 μF tantalum caps at output.

NON-ISOLATED DC/DC CONVERTERS

3.3 Vdc Input

0.9 Vdc - 2.5 Vdc/15 A Output



Ripple and Noise Waveforms

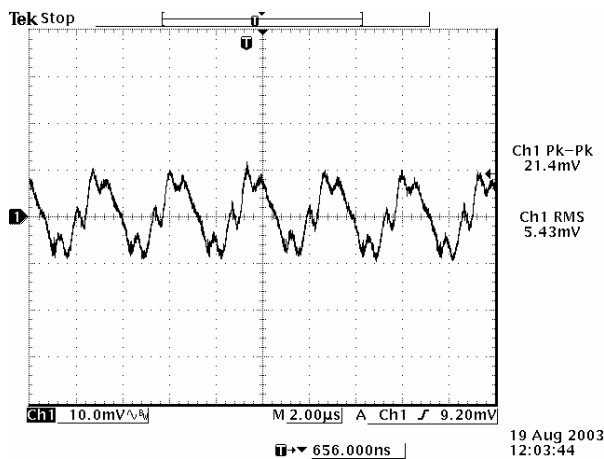
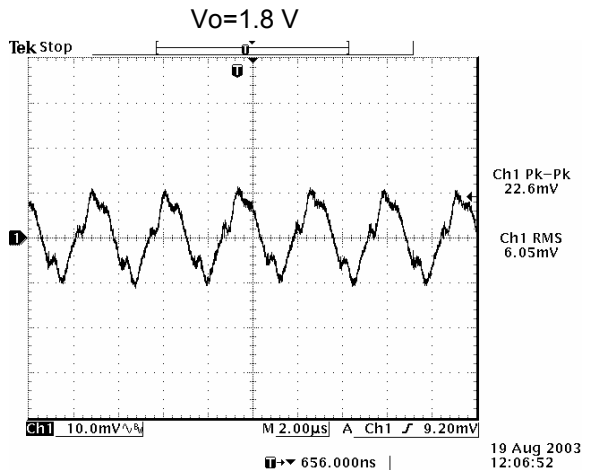
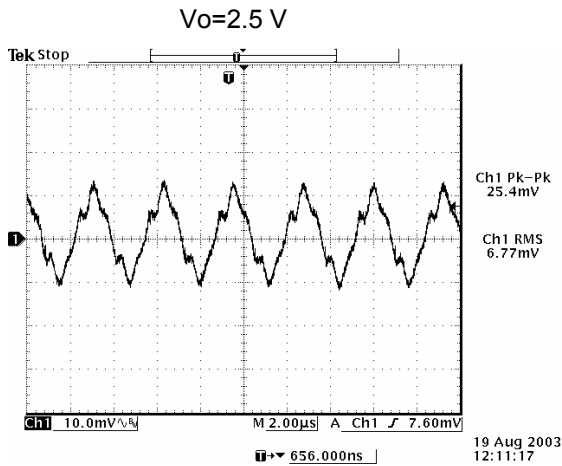
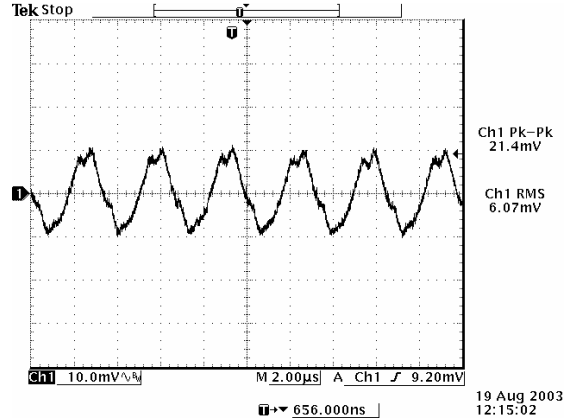
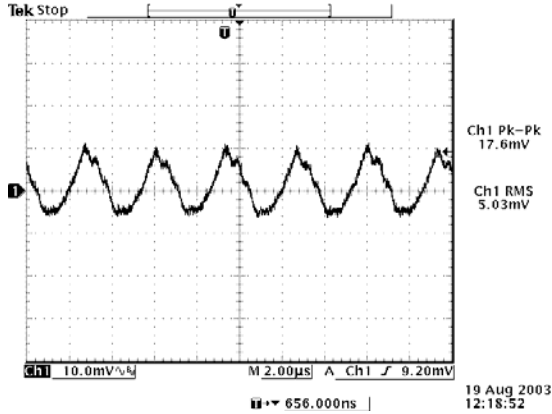

Note: Ripple and noise max load 3.3 V input, 0-20 MHz BW, with 0.1 μF ceramic capacitor and 10 μF aluminum capacitor at the output, $T_a=25\text{ deg C}$.

NON-ISOLATED DC/DC CONVERTERS

3.3 Vdc Input

0.9 Vdc - 2.5 Vdc/15 A Output



Mechanical Outline

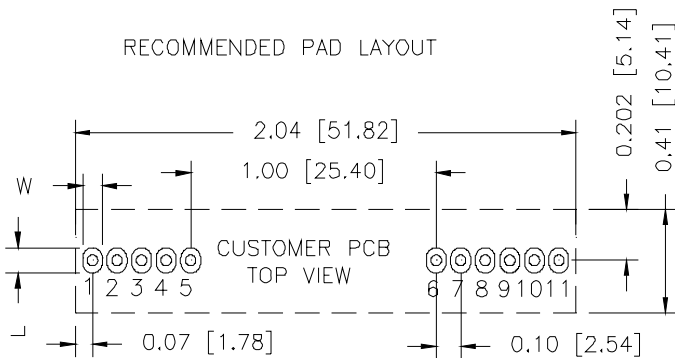
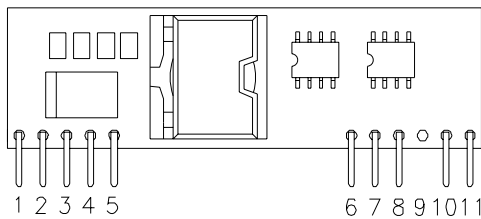
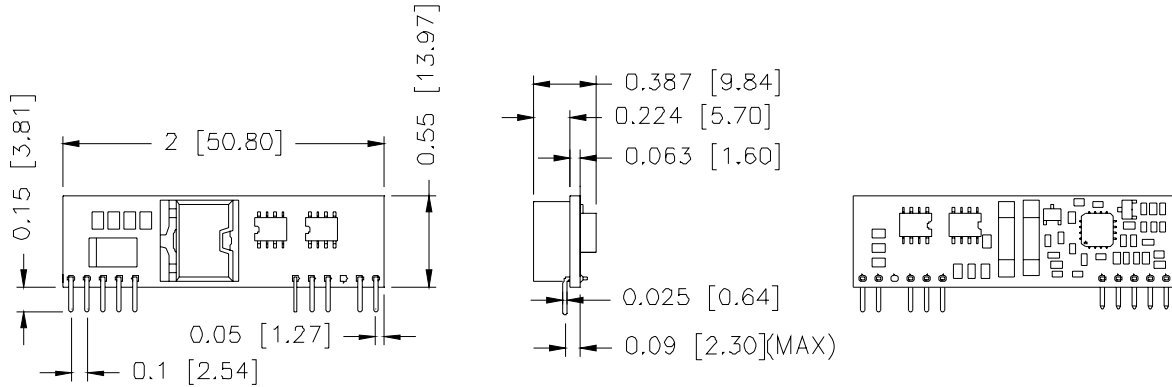

HOLE SIZE: $\varnothing 0.043 \pm 0.003$ [1.08 \pm 0.08]
 PAD SIZE: W 0.063 ± 0.002 [1.63 \pm 0.05]
 L 0.10 ± 0.004 [2.54 \pm 0.10] BOTH SIDE

Pin Connections

Pin	Function
1	Vo+
2	Vo+
3	Opt. Remote Sense (+)
4	Vo+
5	Ground
6	Ground
7	Vin+
8	Vin+
9	Not used
10	Trim
11	Remote On/Off

RoHS Compliance

Complies with the European Directive 2002/95/EC, calling for the elimination of lead and other hazardous substances from electronic products.



©2007 Bel Fuse Inc. Specifications subject to change without notice. 011907

CORPORATE

Bel Fuse Inc.
 206 Van Vorst Street
 Jersey City, NJ 07302
 Tel 201-432-0463
 Fax 201-432-9542
www.belfuse.com

FAR EAST

Bel Fuse Ltd.
 8F/ 8 Luk Hop Street
 San Po Kong
 Kowloon, Hong Kong
 Tel 852-2328-5515
 Fax 852-2352-3706
www.belfuse.com

EUROPE

Bel Fuse Europe Ltd.
 Preston Technology Management Centre
 Marsh Lane, Suite G7, Preston
 Lancashire, PR1 8UD, U.K.
 Tel 44-1772-556601
 Fax 44-1772-888366
www.belfuse.com