

ISOLATED DC/DC CONVERTERS

48 Vdc Input 1.2 Vdc - 12 Vdc / 5 A - 25 A Outputs, 1/16 Brick

bel
POWER PRODUCTS

xRSB-50T Series RoHS Compliant Rev.A

- Isolated
- Fixed Frequency (600 kHz)
- High Efficiency
- High Power Density
- Low Cost
- Output Voltage Trim
- Basic Insulation
- Input Under Voltage Lockout
- Output Over Voltage Shutdown
- OCP/SCP
- Over Temperature Protection
- Remote On/Off (option)
- Positive/Negative Remote Sense
- Through Hole and SMT (option)

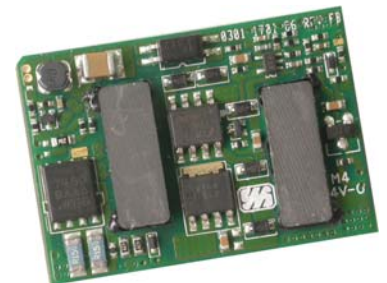

Description

The xRSB-50T series are isolated dc/dc converters that operate from a nominal 48 Vdc source. These units will provide up to 60 W of output power from a nominal 48 Vdc input. These units are designed to be highly efficient and low cost. Features include remote on/off, over current protection and under voltage lockout. These converters are provided in an industry standard sixteenth brick package.

Part Selection

Output Voltage	Input Voltage	Max. Output Current	Max. Output Power	Typical Efficiency	Model Number Active Low	Model Number Active High
1.2 V	36 V - 75 V	25 A	30 W	84%	xRSB-50TV2L	xRSB-50TV20
1.5 V	36 V - 75 V	22 A	33 W	85%	xRSB-50TV5L	xRSB-50TV50
1.8 V	36 V - 75 V	20 A	36 W	87%	xRSB-50TV8L	xRSB-50TV80
2.5 V	36 V - 75 V	18 A	45 W	87%	xRSB-50T02L	xRSB-50T025
3.3 V	36 V - 75 V	15 A	50 W	89%	xRSB-50T03L	xRSB-50T033
5.0 V	36 V - 75 V	12 A	60 W	90%	xRSB-50T05L	xRSB-50T050
12 V	36 V - 75 V	5 A	60 W	89%	xRSB-50T12L	xRSB-50T120

- Notes:** 1. Add "G" suffix at the end of the model number to indicate Tray Packaging. Replace "x" with "S" to indicate SMT package, or "0" to indicate through hole package.
2. All part numbers above indicate RoHS 6. Change the second letter "R" to "7" for RoHS 5 part numbers.

Absolute Maximum Ratings

Parameter	Min	Typ	Max	Notes
Input Voltage (continuous)	-0.3 V	-	80 V	
Input Voltage Transient (100 ms)	-0.3 V		100 V	
Remote On/Off	-0.3 V	-	18 V	
I/O Isolation Voltage	-	-	1500 V	
Ambient Temperature	-40 °C	-	85 °C	
Storage Temperature	-55 °C	-	125 °C	

ISOLATED DC/DC CONVERTERS

48 Vdc Input 1.2 Vdc - 12 Vdc / 5 A - 25 A Outputs, 1/16 Brick



Input Specifications

Parameter	Min	Typ	Max	Notes
Input Voltage	36 V	48 V	75 V	
Input Current (full load)	-	-	2.4 A	
Input Current (no load)	-	70 mA	120 mA	
Remote Off Input Current	-	1 mA	3 mA	
Input Reflected Ripple Current (pk-pk)	-	20 mA	50 mA	Tested with simulated source impedance of 15 uH, 5 Hz to 20 MHz; use a 100 uF/100 V electrolytic capacitor with ESR=1 ohm max at 200 kHz at the input.
Input Reflected Ripple Current (rms)	-	3 mA	7 mA	
I ² t Inrush Current Transient	-	0.01 A ² s	0.02 A ² s	
Turn On Voltage Threshold	31 V	32 V	35 V	
Turn Off Voltage Threshold	30 V	31 V	34 V	

Note: All specifications are typical at nominal input, full load at 25 °C unless otherwise stated.

Output Specifications

Parameter	Min	Typ	Max	Notes
Output Voltage Set Point				Test conditions: Vin=48 V; Io=50% load
Vo=1.2 V	1.182 V	1.2 V	1.218 V	
Vo=1.5 V	1.478 V	1.5 V	1.523 V	
Vo=1.8 V	1.773 V	1.8 V	1.827 V	
Vo=2.5 V	2.463 V	2.5 V	2.538 V	
Vo=3.3 V	3.250 V	3.3 V	3.350 V	
Vo=5.0 V	4.925 V	5.0 V	5.075 V	
Vo=12 V	11.750 V	12.0 V	12.250 V	
Line Regulation				
Vo=1.2 - 1.8 V	-	±0.5 mV	±3 mV	
Vo=2.5 V	-	±1 mV	±4 mV	
Vo=3.3 V	-	±3 mV	±8 mV	
Vo=5.0 V	-	±4 mV	±9 mV	
Vo=12 V	-	±10 mV	±25 mV	
Load Regulation				
Vo=1.2 - 2.5 V	-	±3 mV	±5 mV	
Vo=3.3 - 5.0 V	-	±4 mV	±9 mV	
Vo=12 V	-	±9 mV	±18 mV	
Regulation Over Temperature(-40 °C to +85 °C)				
Vo=1.2 V	-	±4 mV	±9 mV	
Vo=1.5 - 1.8 V	-	±6 mV	±14 mV	
Vo=2.5 - 3.3 V	-	±9 mV	±16 mV	
Vo=5.0 V	-	±15 mV	±30 mV	
Vo=12 V	-	±20 mV	±35 mV	
Output Current				
Vo=1.2 V	0 A	-	25 A	
Vo=1.5 V	0 A	-	22 A	
Vo=1.8 V	0 A	-	20 A	
Vo=2.5 V	0 A	-	18 A	
Vo=3.3 V	0 A	-	15 A	
Vo=5.0 V	0 A	-	12 A	
Vo=12 V	0 A	-	5 A	

ISOLATED DC/DC CONVERTERS

48 Vdc Input 1.2 Vdc - 12 Vdc / 5 A - 25 A Outputs, 1/16 Brick



Output Specifications (continued)

Parameter		Min	Typ	Max	Notes	
Current Limit Threshold	Vo=1.2 V	30 A	40 A	47 A		
	Vo=1.5 V	28 A	34 A	40 A		
	Vo=1.8 V	24 A	28 A	34 A		
	Vo=2.5 V	22 A	26 A	30 A		
	Vo=3.3 V	19 A	22 A	26 A		
	Vo=5.0 V	14 A	19 A	24 A		
	Vo=12 V	5.2 A	6.5 A	8.5 A		
Short Circuit Surge Transient		-	0.5 A ² s	1 A ² s		
Ripple and Noise (rms)	Vo=1.2 - 1.8 V	-	6 mV	12 mV	Tested at 0-20 MHz BW, with a 1 uF ceramic capacitor and a Tantalum capacitor (refer to the min. output capacitance below for each output) at the output.	
	Vo=2.5 V	-	10 mV	20 mV		
	Vo=3.3 V	-	12 mV	25 mV		
	Vo=5.0 V	-	25 mV	50 mV		
	Vo=12 V	-	30 mV	55 mV		
Ripple and Noise (pk-pk)	Vo=1.2 - 1.8 V	-	40 mV	70 mV	Tested at 0-20 MHz BW, with a 1 uF ceramic capacitor and a Tantalum capacitor (refer to the min. output capacitance below for each output) at the output.	
	Vo=2.5 V	-	45 mV	80 mV		
	Vo=3.3 V	-	55 mV	90 mV		
	Vo=5.0 V	-	70 mV	120 mV		
	Vo=12 V	-	90 mV	180 mV		
Turn on Time		-	35 mS	70 mS		
Overshoot at Turn on		-	0%	5%		
Output Capacitance	Vo=1.2 V	470 uF	-	20000 uF	Recommend to use AVX TPS series Tantalum capacitor as the min capacitor	
	Vo=1.5 V	470 uF	-	15000 uF		
	Vo=1.8 - 2.5 V	470 uF	-	10000 uF		
	Vo=3.3 V	220 uF	-	5600 uF		
	Vo=5.0 V	100 uF	-	4700 uF		
	Vo=12 V	22 uF	-	470 uF		
Transient Response						
25% ~ 50% Max Load	Overshoot	Vo=1.2 V	-	40 mV	80 mV	Test conditions: di/dt = 0.1 A/uS, Vin=48 V, with a 1uF ceramic capacitor and a Tantalum capacitor (refer to the min. output capacitance above for each output) at the output.
	Settling Time		-	80 uS	150 uS	
50% ~ 25% Max Load	Overshoot	Vo=1.2 V	-	40 mV	80 mV	
	Settling Time		-	80 uS	150 uS	
25% ~ 50% Max Load	Overshoot	Vo=1.5 - 1.8 V	-	110 mV	150 mV	
	Settling Time		-	110 uS	180 uS	
50% ~ 25% Max Load	Overshoot	Vo=1.5 - 1.8 V	-	110 mV	150 mV	
	Settling Time		-	110 uS	180 uS	
25% ~ 50% Max Load	Overshoot	Vo=2.5 - 3.3 V	-	150 mV	250 mV	
	Settling Time		-	120 uS	200 uS	
50% ~ 25% Max Load	Overshoot	Vo=2.5 - 3.3 V	-	150 mV	250 mV	
	Settling Time		-	120 uS	200 uS	
25% ~ 50% Max Load	Overshoot	Vo=5.0 V	-	220 mV	350 mV	
	Settling Time		-	120 uS	250 uS	
50% ~ 25% Max Load	Overshoot	Vo=5.0 V	-	220 mV	350 mV	
	Settling Time		-	120 uS	250 uS	
25% ~ 50% Max Load	Overshoot	Vo=12 V	-	400 mV	650 mV	
	Settling Time		-	150 uS	300 uS	
50% ~ 25% Max Load	Overshoot	Vo=12 V	-	400 mV	650 mV	
	Settling Time		-	150 uS	300 uS	

Note: All specifications are typical at nominal input, full load at 25 °C unless otherwise stated.

ISOLATED DC/DC CONVERTERS

48 Vdc Input 1.2 Vdc - 12 Vdc / 5 A - 25 A Outputs, 1/16 Brick



General Specifications

Parameter	Min	Typ	Max	Notes
Efficiency				
Vo=1.2 V	81%	84%	-	Vin=48 V, full load
Vo=1.5 V	82%	85%	-	
Vo=1.8 - 2.5 V	84%	87%	-	
Vo=3.3 V	86%	89%	-	
Vo=5.0 V	87%	90%	-	
Vo=12 V	86%	89%	-	
Switching Frequency	540 kHz	600 kHz	660 kHz	
Isolation Capacitance	-	3900 pF	-	
Output Voltage Trim Range				
Vo=1.2 - 5.0 V	90% Vo	-	110% Vo	
Vo=12 V	80% Vo	-	110% Vo	
Over Temperature Protection	120 °C	-	140 °C	
Over Voltage Protection	-	130% Vo	160% Vo	Test conditions: Vin=48 V, full load and short the feedback optocoupler.
MTBF	2,770,832 hours			Calculated Per Bell Core SR-332 (Io=80% load, Vin=48 V, Vo=5 V; Ta = 25 °C)
Dimensions				SMT Package
Inches (L x W x H)	1.3 x 0.9 x 0.364			
Millimeters (L x W x H)	33.02 x 22.86 x 9.24			
Dimensions				Through Hole Package
Inches (L x W x H)	1.3 x 0.9 x 0.378			
Millimeters (L x W x H)	33.02 x 22.86 x 9.60			
Weight	-	13 g	-	

Note: All specifications are typical at 25 °C unless otherwise stated.

Control Specifications

Parameter	Min	Typ	Max	Notes	
Remote On/Off					
Signal Low (Unit On)	Active Low	-0.3 V	-	When Remote On/Off pin is open, for active low option, unit is off; for active high option, unit is on	
Signal High (Unit Off)		2.95 V	-		18 V
Signal Low (Unit Off)	Active High	-0.3 V	-		0.8 V
Signal High (Unit On)		2.95 V	-		18 V
Current Sink	-	0 mA	-	1 mA	

ISOLATED DC/DC CONVERTERS

48 Vdc Input 1.2 Vdc - 12 Vdc / 5 A - 25 A Outputs, 1/16 Brick

bel
POWER PRODUCTS

Output Trim Equations

Equations for calculating the trim resistor are shown below (Unit: kΩ). The Trim Down resistor should be connected between the Trim pin and Ground pin. The Trim Up resistor should be connected between the Trim pin and the Vout. Only one of the resistors should be used for any given application.

1) Trim Equations for Vo=1.2 V

$$R_{trimdown} = \frac{511}{|\delta|} - 10.22$$

$$R_{trimup} = \frac{(100 + \delta) \cdot V_o \cdot 5.11 - 313}{0.6125 \cdot \delta} - 10.22$$

Note:

$$\delta = \frac{(V_o_{req} - V_o)}{V_o} \times 100[\%]$$

V_{o_req}=Desired (trimmed) output voltage [V] V_o=1.202 V

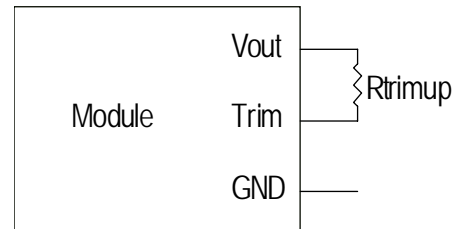
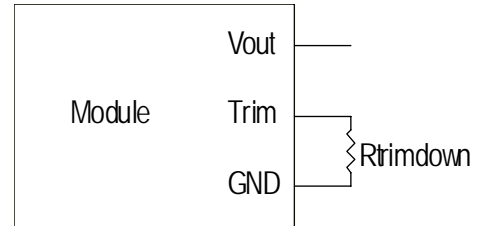

2) Trim Equations for Vo=1.5 V - 12 V

$$R_{trimdown} = \frac{511}{|\delta|} - 10.22$$

$$R_{trimup} = \frac{(100 + \delta) \cdot V_o \cdot 511 - 626}{1.225 \cdot \delta} - 10.22$$

Note:

$$\delta = \frac{(V_o_{req} - V_o)}{V_o} \times 100[\%]$$

V_{o_req}=Desired (trimmed) output voltage [V]

V_o=1.503 V for 1.5 V output; V_o=1.804 V for 1.8 V output; V_o=2.505 V for 2.5 V output; V_o=3.308 V for 3.3 V output; V_o=5.002 V for 5 V output; V_o=12.007 V for 12 V output.

ISOLATED DC/DC CONVERTERS

48 Vdc Input 1.2 Vdc - 12 Vdc / 5 A - 25 A Outputs, 1/16 Brick



Efficiency Data

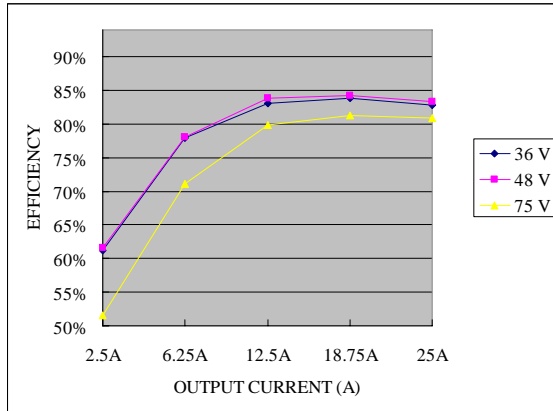

Vo=1.2 V

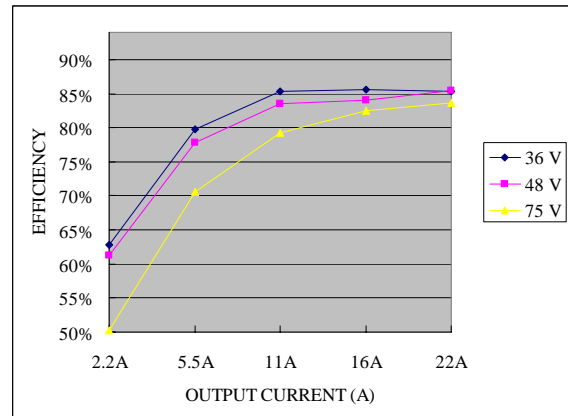

Vo=1.5 V

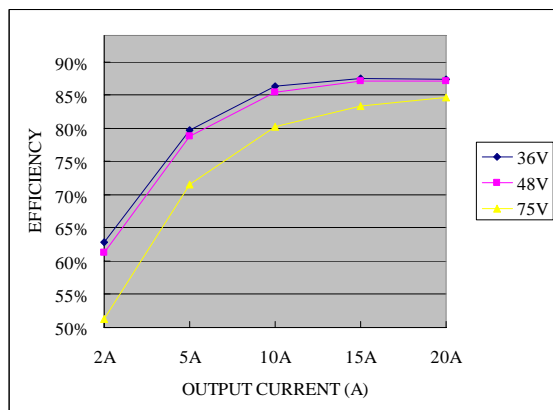

Vo=1.8 V

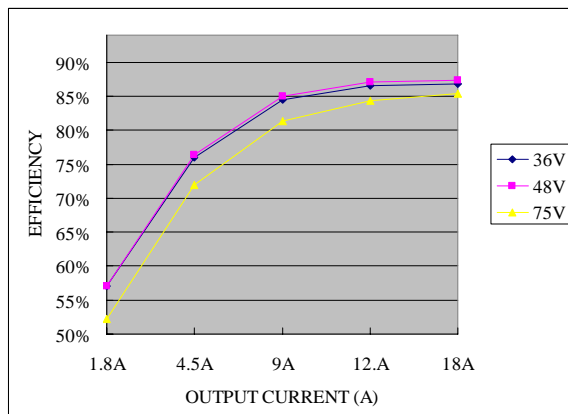

Vo=2.5 V

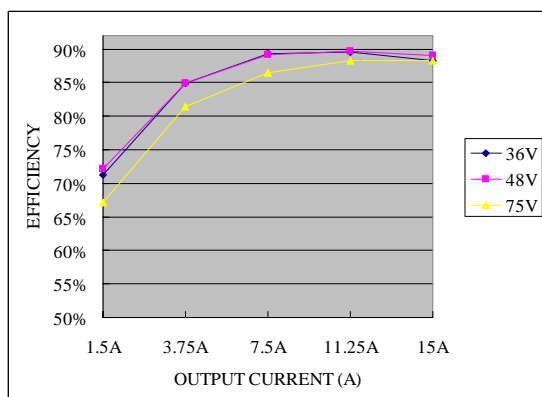

Vo=3.3 V

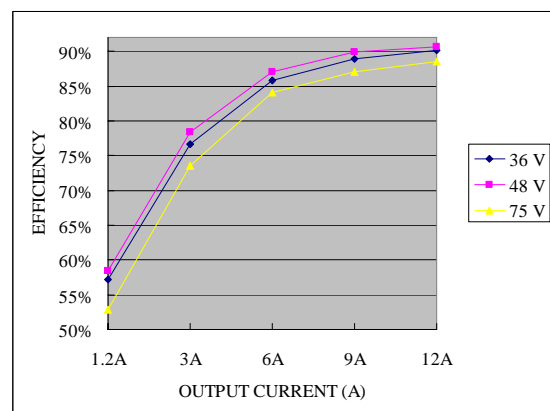

Vo=5.0 V

ISOLATED DC/DC CONVERTERS

48 Vdc Input 1.2 Vdc - 12 Vdc / 5 A - 25 A Outputs, 1/16 Brick



Efficiency Data (continued)

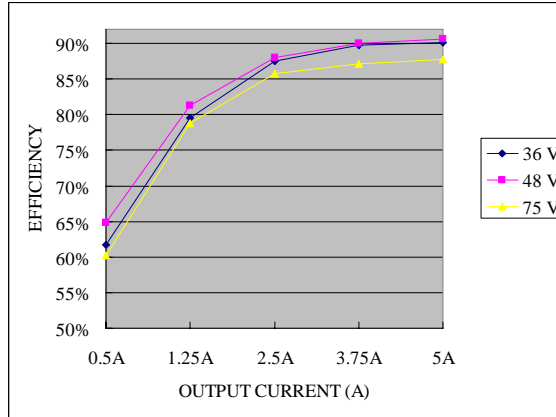

Vo=12 V

Thermal Derating Curves

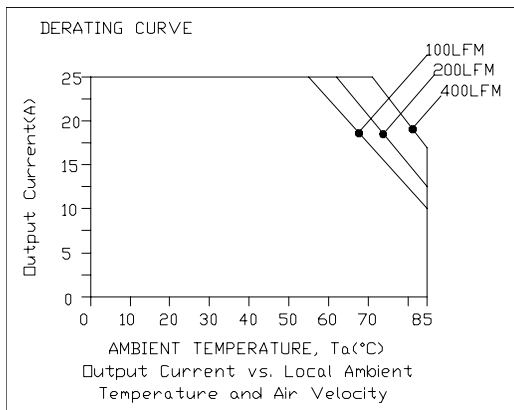

Vin=48 V, Vo=1.2 V

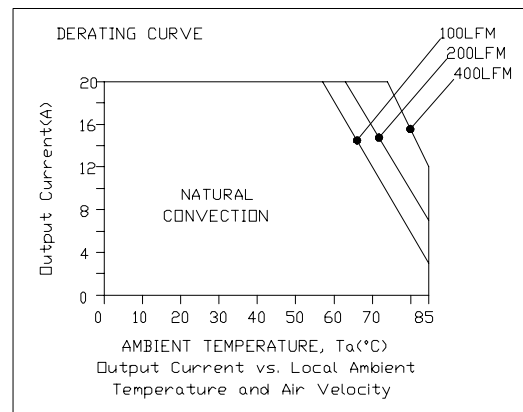

Vin=48 V, Vo=1.8 V

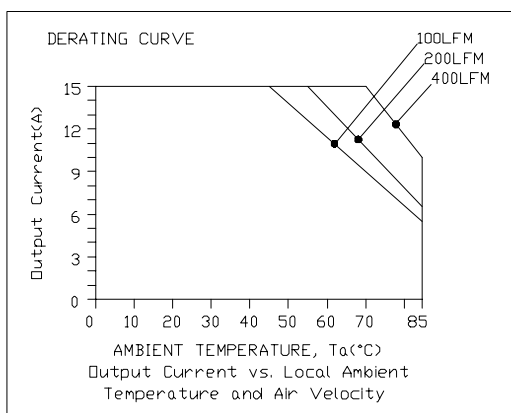

Vin=48 V, Vo=3.3 V,

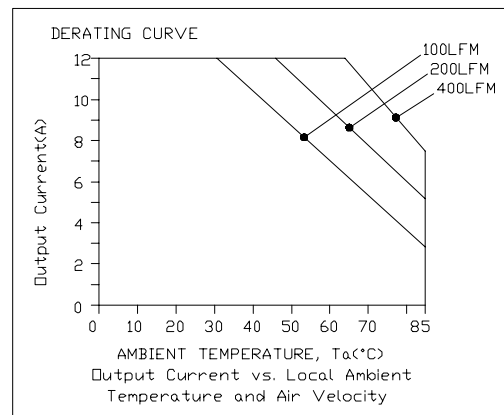

Vin=48 V, Vo=5.0 V

ISOLATED DC/DC CONVERTERS

48 Vdc Input 1.2 Vdc - 12 Vdc / 5 A - 25 A Outputs, 1/16 Brick



Thermal Derating Curves (continued)

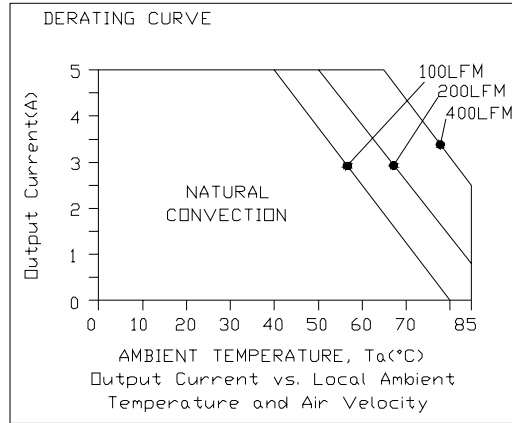

$V_{in}=48\text{ V}$, $V_o=12\text{ V}$

Ripple and Noise Waveforms

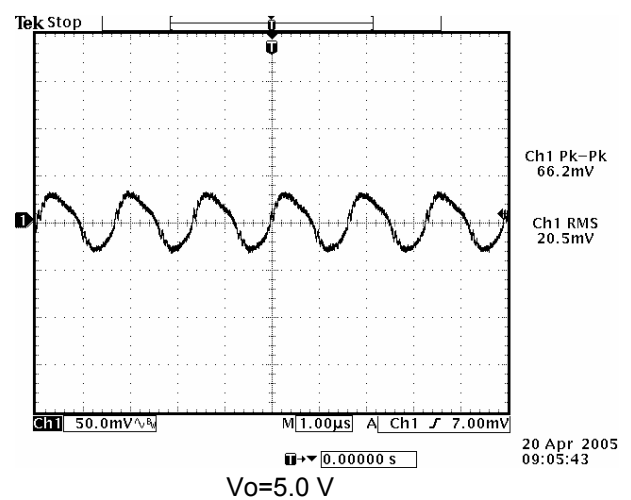
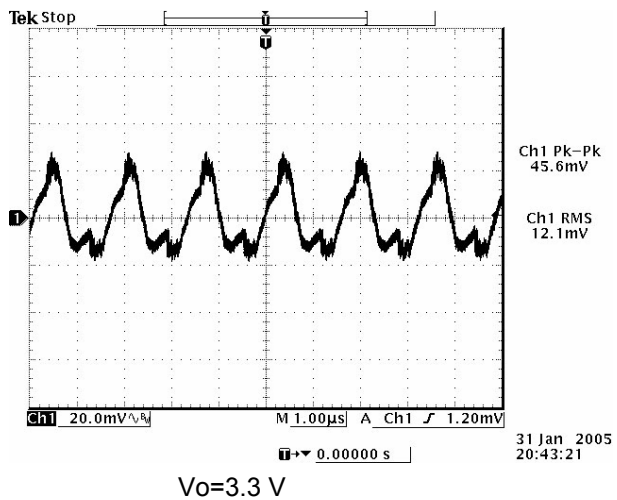
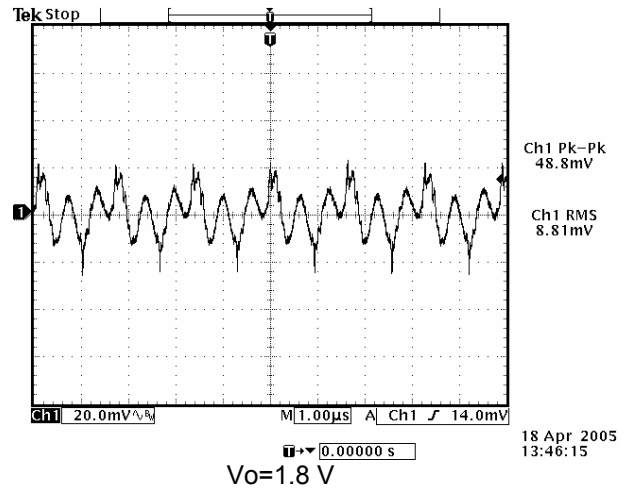
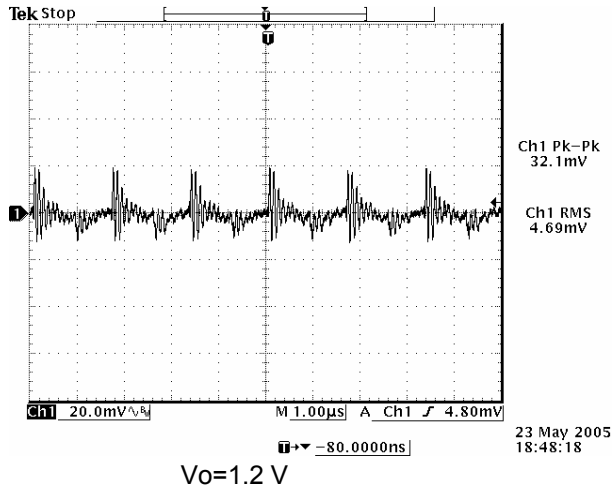

ISOLATED DC/DC CONVERTERS

48 Vdc Input 1.2 Vdc - 12 Vdc / 5 A - 25 A Outputs, 1/16 Brick



Ripple and Noise Waveforms (continued)

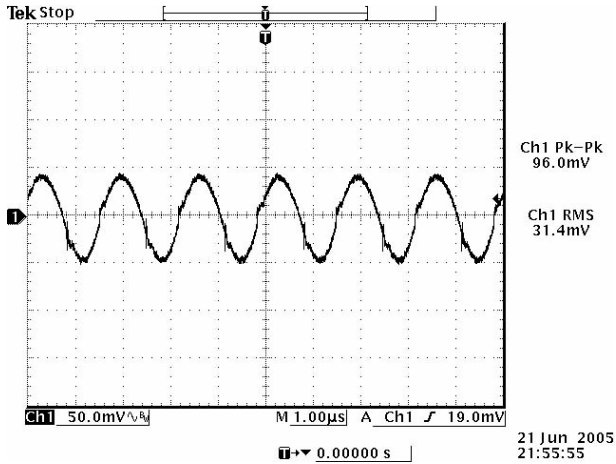

Vo=12 V

Ripple & Noise Test Conditions

- 1) For Vo=1.2 V -1.8 V: Full load, 48 V input, with a 1 uF ceramic capacitor and a 470 uF tantalum cap at the output, and Ta=25 deg C.
- 2) For Vo=3.3 V: Full load, 48 V input, with a 1 uF ceramic capacitor and a 220 uF tantalum cap at the output, and Ta=25 deg C.
- 3) For Vo=5.0 V: Full load, 48 V input, with a 1 uF ceramic capacitor and a 100 uF tantalum cap at the output, and Ta=25 deg C.
- 4) For Vo=12 V: Full load, 48 V input, with a 1 uF ceramic capacitor and a 22 uF tantalum cap at the output, and Ta=25 deg C.

Transient Response Waveforms

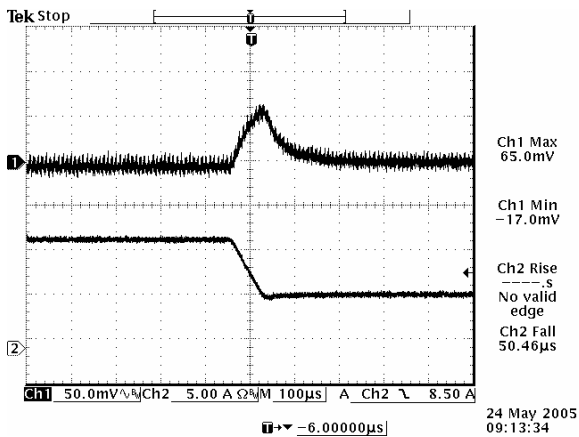

Vo=1.2 V 50% to 25% Load Transients

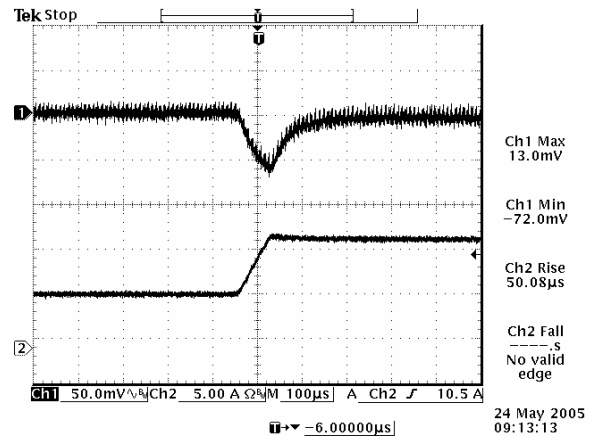

Vo=1.2 V 25% to 50% Load Transients

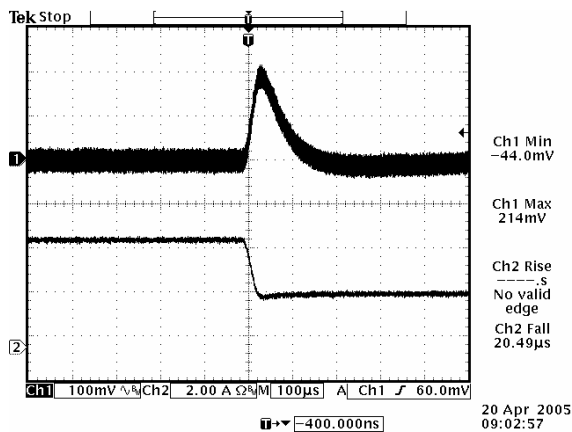

Vo=1.8 V 50% to 25% Load Transients

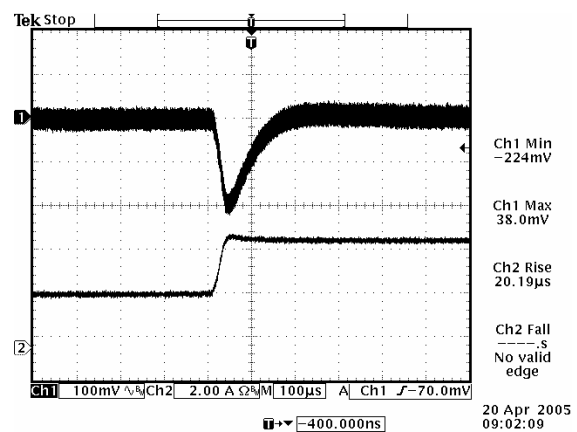

Vo=1.8 V 25% to 50% Load Transients

ISOLATED DC/DC CONVERTERS

48 Vdc Input 1.2 Vdc - 12 Vdc / 5 A - 25 A Outputs, 1/16 Brick



Transient Response Waveforms (continued)

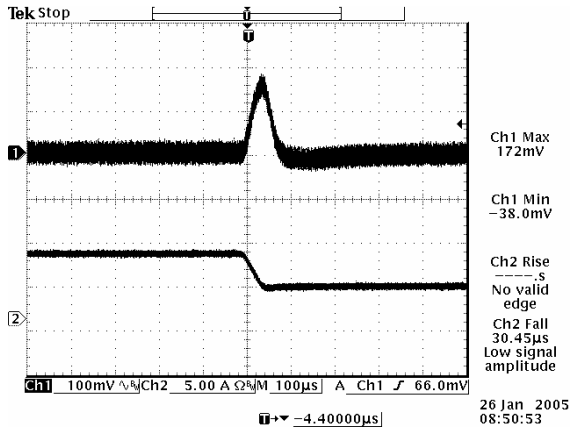

Vo=3.3 V 50% to 25% Load Transients

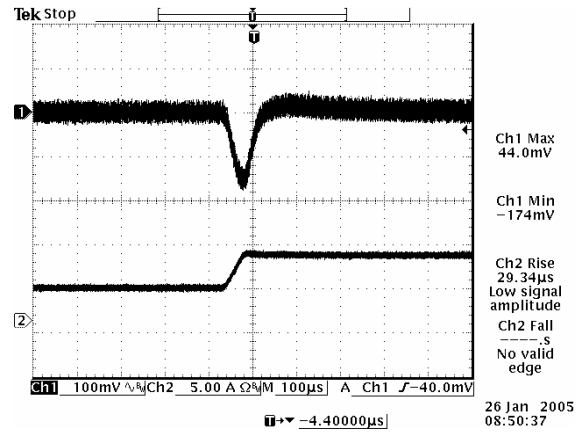

Vo=3.3 V 25% to 50% Load Transients

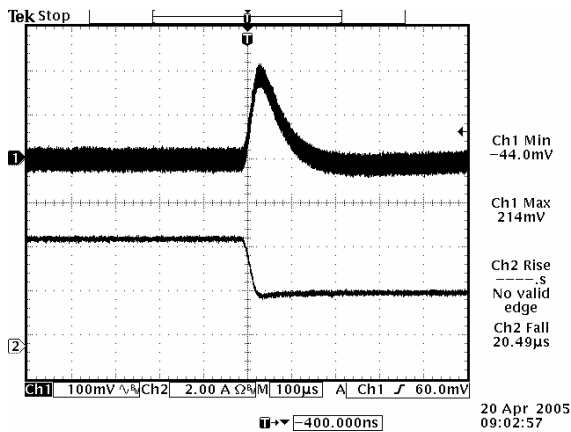

Vo=5 V 50% to 25% Load Transients

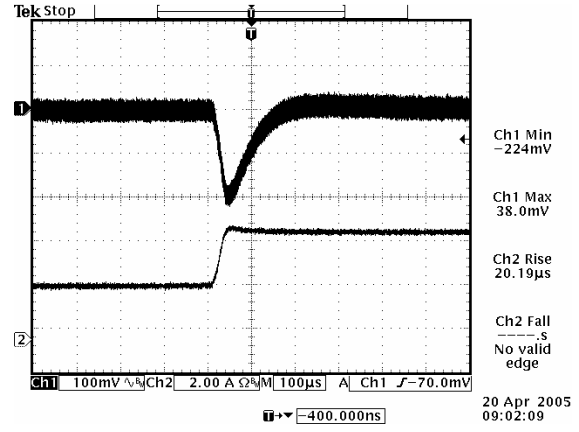

Vo=5 V 25% to 50% Load Transients

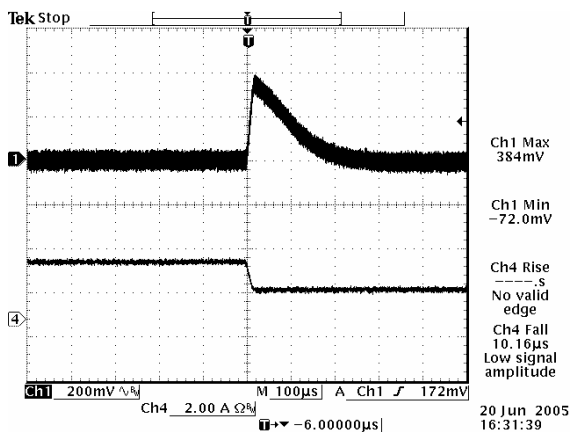

Vo=12 V 50% to 25% Load Transients

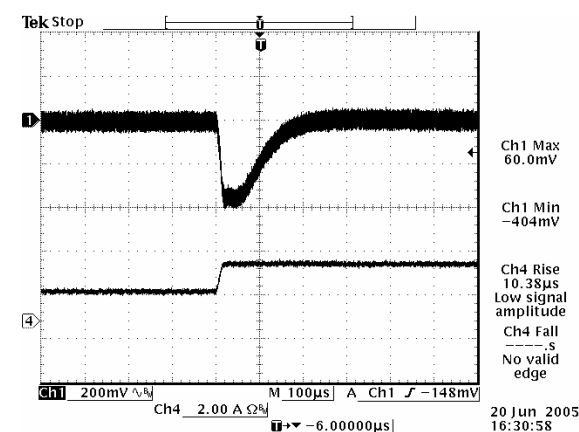

Vo=12 V 25% to 50% Load Transients

Note: Vin=48 V, di/dt=0.1A/uS, with external tantalum capacitor (refer to the min. output capacitance in the Output Specifications table for each output) and 1 uF ceramic capacitor, and Ta=25 deg C.

ISOLATED DC/DC CONVERTERS

48 Vdc Input 1.2 Vdc - 12 Vdc / 5 A - 25 A Outputs, 1/16 Brick



Mechanical Outline

SMT Package

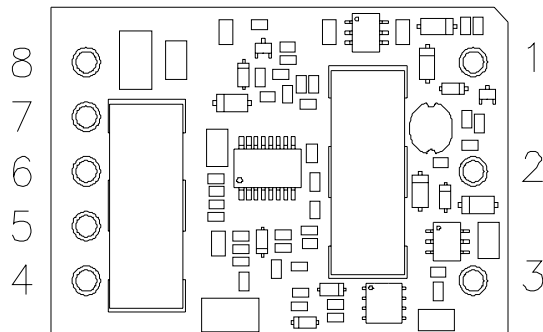
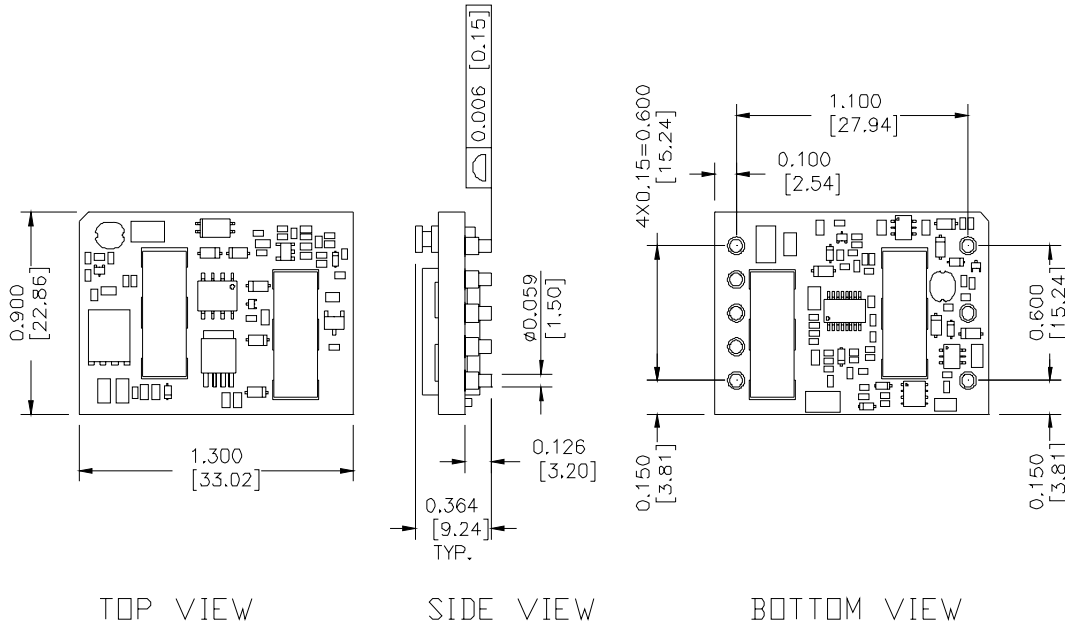

RECOMMENDED PCB PAD LAYOUT

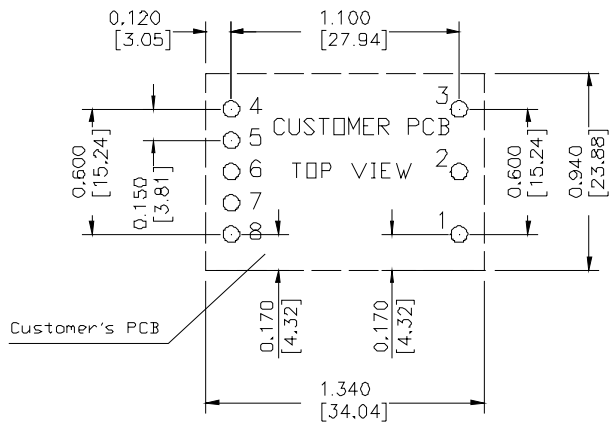

Pin Connections

Pin	Function
1	Vin (+)
2	Remote On/Off
3	Vin (-)
4	Vout-
5	Remote Sense (-)
6	Trim
7	Remote Sense (+)
8	Vout (+)

Recommended Surface Mount Pads
 Min. $\phi 0.080$ " [2.03]
 Max. $\phi 0.092$ " [2.34]

ISOLATED DC/DC CONVERTERS

48 Vdc Input 1.2 Vdc - 12 Vdc / 5 A - 25 A Outputs, 1/16 Brick



Mechanical Outline (continued)

Through Hole Package

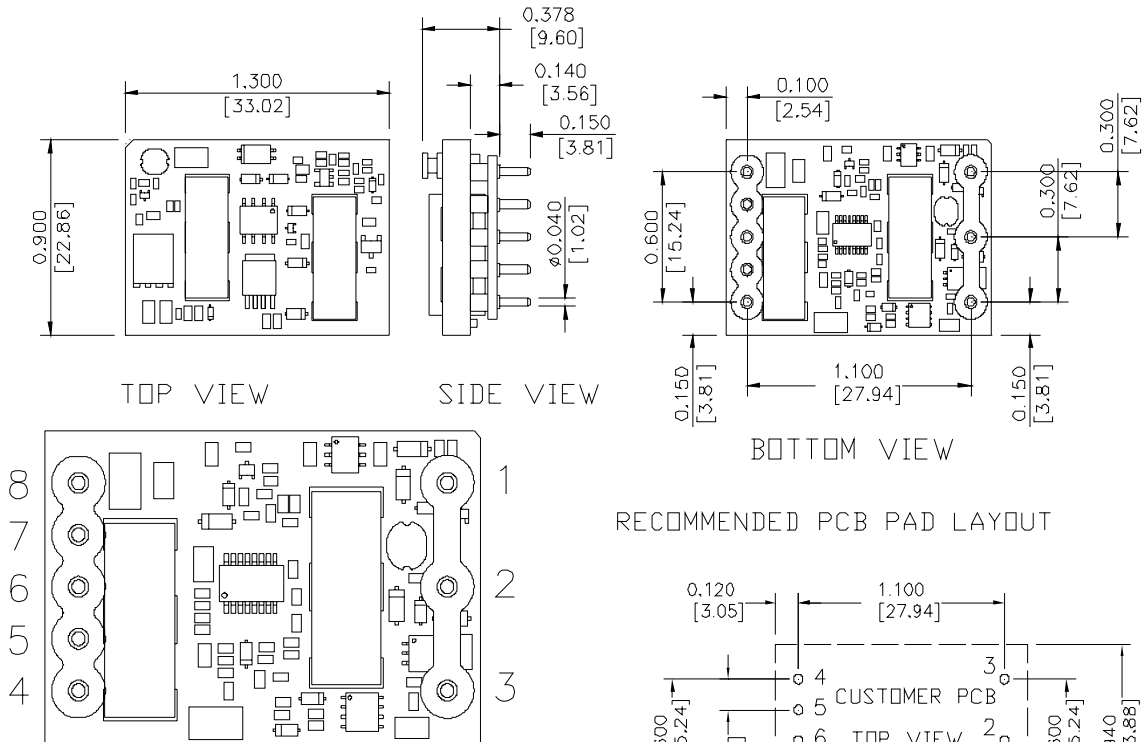

Pin Connections

Pin	Function
1	Vin (+)
2	Remote On/Off
3	Vin (-)
4	Vout-
5	Remote Sense (-)
6	Trim
7	Remote Sense (+)
8	Vout (+)

HOLE SIZE: $\phi 0.047$ [1.19]
PAD SIZE: $\phi 0.08$ [2.03] BOTH SIDES

RoHS Compliance

Complies with the European Directive 2002/95/EC, calling for the elimination of lead and other hazardous substances from electronic products.



©2007 Bel Fuse Inc. Specifications subject to change without notice. 010507

CORPORATE

Bel Fuse Inc.
206 Van Vorst Street
Jersey City, NJ 07302
Tel 201-432-0463
Fax 201-432-9542
www.belfuse.com

FAR EAST

Bel Fuse Ltd.
8F/ 8 Luk Hop Street
San Po Kong
Kowloon, Hong Kong
Tel 852-2328-5515
Fax 852-2352-3706
www.belfuse.com

EUROPE

Bel Fuse Europe Ltd.
Preston Technology Management Centre
Marsh Lane, Suite G7, Preston
Lancashire, PR1 8UD, U.K.
Tel 44-1772-556601
Fax 44-1772-888366
www.belfuse.com